



**PROVINCIAL GOVERNMENT OF CAMARINES NORTE
DAET**

**ESTABLISHMENT OF
PROVINCIAL EMERGENCY
OPERATIONS CENTER (EOC) –
PHASE I**

Provincial Capitol
Building, Daet, Camarines
Norte

April 2, 2024

Preface

These Philippine Bidding Documents (PBDs) for the procurement of Infrastructure Projects (hereinafter referred to also as the “Works”) through Competitive Bidding have been prepared by the Government of the Philippines for use by all branches, agencies, departments, bureaus, offices, or instrumentalities of the government, including government-owned and/or -controlled corporations, government financial institutions, state universities and colleges, local government units, and autonomous regional government. The procedures and practices presented in this document have been developed through broad experience, and are for mandatory use in projects that are financed in whole or in part by the Government of the Philippines or any foreign government/foreign or international financing institution in accordance with the provisions of the 2016 revised Implementing Rules and Regulations (IRR) of Republic Act (RA) No. 9184.

The PBDs are intended as a model for admeasurements (unit prices or unit rates in a bill of quantities) types of contract, which are the most common in Works contracting.

The Bidding Documents shall clearly and adequately define, among others: (i) the objectives, scope, and expected outputs and/or results of the proposed contract; (ii) the eligibility requirements of Bidders; (iii) the expected contract duration; and (iv) the obligations, duties, and/or functions of the winning Bidder.

Care should be taken to check the relevance of the provisions of the PBDs against the requirements of the specific Works to be procured. If duplication of a subject is inevitable in other sections of the document prepared by the Procuring Entity, care must be exercised to avoid contradictions between clauses dealing with the same matter.

Moreover, each section is prepared with notes intended only as information for the Procuring Entity or the person drafting the Bidding Documents. They shall not be included in the final documents. The following general directions should be observed when using the documents:

- a. All the documents listed in the Table of Contents are normally required for the procurement of Infrastructure Projects. However, they should be adapted as necessary to the circumstances of the particular Project.
- b. Specific details, such as the “*name of the Procuring Entity*” and “*address for bid submission,*” should be furnished in the Instructions to Bidders, Bid Data Sheet, and Special Conditions of Contract. The final documents should contain neither blank spaces nor options.
- c. This Preface and the footnotes or notes in italics included in the Invitation to Bid, BDS, General Conditions of Contract, Special Conditions of Contract, Specifications, Drawings, and Bill of Quantities are not part of the text of the final document, although they contain instructions that the Procuring Entity should strictly follow.
- d. The cover should be modified as required to identify the Bidding Documents as to the names of the Project, Contract, and Procuring Entity, in addition to date of issue.

- e. Modifications for specific Procurement Project details should be provided in the Special Conditions of Contract as amendments to the Conditions of Contract. For easy completion, whenever reference has to be made to specific clauses in the Bid Data Sheet or Special Conditions of Contract, these terms shall be printed in bold typeface on Sections I (Instructions to Bidders) and III (General Conditions of Contract), respectively.
- f. For guidelines on the use of Bidding Forms and the procurement of Foreign-Assisted Projects, these will be covered by a separate issuance of the Government Procurement Policy Board.

TABLE OF CONTENTS

GLOSSARY OF	5
TERMS, ABBREVIATIONS, AND ACRONYMS	5
SECTION I. INVITATION TO BID	8
SECTION II. INSTRUCTIONS TO BIDDERS.....	11
1. Scope of Bid	12
2. Funding Information.....	12
3. Bidding Requirements	12
4. Corrupt, Fraudulent, Collusive, Coercive, and Obstructive Practices	13
5. Eligible Bidders	13
6. Origin of Associated Goods	13
7. Subcontracts	13
8. Pre-Bid Conference	14
9. Clarification and Amendment of Bidding Documents	14
10. Documents Comprising the Bid: Eligibility and Technical Components.....	14
11. Documents Comprising the Bid: Financial Component.....	15
12. Alternative Bids.....	15
13. Bid Prices	15
14. Bid and Payment Currencies	16
15. Bid Security.....	16
16. Sealing and Marking of Bids.....	16
17. Deadline for Submission of Bids.....	16
18. Opening and Preliminary Examination of Bids.....	16
19. Detailed Evaluation and Comparison of Bids	17
20. Post Qualification	17
21. Signing of the Contract.....	17
SECTION III. BID DATA SHEET	18
SECTION IV. GENERAL CONDITIONS OF CONTRACT	20
1. Scope of Contract	21
2. Sectional Completion of Works	21
3. Possession of Site	21
4. The Contractor's Obligations	21
5. Performance Security	22

6.	Site Investigation Reports.....	22
7.	Warranty.....	22
8.	Liability of the Contractor.....	22
9.	Termination for Other Causes.....	22
10.	Dayworks.....	23
11.	Program of Work.....	23
12.	Instructions, Inspections and Audits.....	23
13.	Advance Payment.....	23
14.	Progress Payments.....	23
15.	Operating and Maintenance Manuals.....	23
SECTION V. SPECIAL CONDITIONS OF CONTRACT.....		25
SECTION VI. SPECIFICATIONS.....		27
ITEM 101 – REMOVAL OF STRUCTURES AND OBSTRUCTION.....		28
ITEM 404 – REINFORCING STEEL.....		30
ITEM 405 – STRUCTURAL CONCRETE.....		33
ITEM - WINDOWS.....		44
ITEM - DOORS.....		44
ITEM - ELECTRICAL WORKS.....		46
ITEM - PLUMBING WORKS.....		46
ITEM 409 - WELDED STRUCTURAL STEEL.....		47
ITEM 1032 - PAINTING, VARNISHING AND OTHER RELATED WORKS.....		66
SECTION VII. DRAWINGS.....		68
SECTION VIII. BILL OF QUANTITIES.....		80
SECTION IX. CHECKLIST OF TECHNICAL AND FINANCIAL DOCUMENTS.....		83
BID FORM.....		86
BID SECURING DECLARATION.....		88
CONTRACT AGREEMENT FORM.....		89
OMNIBUS SWORN STATEMENT.....		91
AFFIDAVIT OF SITE INSPECTION.....		95
AFFIDAVIT OF AVAILABILITY OF KEY PERSONNEL AND EQUIPMENT.....		96
KEY PERSONNEL’S CERTIFICATE OF EMPLOYMENT.....		97
DPWH DEPARTMENT ORDER 197 S.2016.....		99

Glossary of Terms, Abbreviations, and Acronyms

ABC – Approved Budget for the Contract.

ARCC – Allowable Range of Contract Cost.

BAC – Bids and Awards Committee.

Bid – A signed offer or proposal to undertake a contract submitted by a bidder in response to and in consonance with the requirements of the bidding documents. Also referred to as *Proposal* and *Tender*. (2016 revised IRR, Section 5[c])

Bidder – Refers to a contractor, manufacturer, supplier, distributor and/or consultant who submits a bid in response to the requirements of the Bidding Documents. (2016 revised IRR, Section 5[d])

Bidding Documents – The documents issued by the Procuring Entity as the bases for bids, furnishing all information necessary for a prospective bidder to prepare a bid for the Goods, Infrastructure Projects, and/or Consulting Services required by the Procuring Entity. (2016 revised IRR, Section 5[e])

BIR – Bureau of Internal Revenue.

BSP – Bangko Sentral ng Pilipinas.

CDA – Cooperative Development Authority.

Consulting Services – Refer to services for Infrastructure Projects and other types of projects or activities of the GOP requiring adequate external technical and professional expertise that are beyond the capability and/or capacity of the GOP to undertake such as, but not limited to: (i) advisory and review services; (ii) pre-investment or feasibility studies; (iii) design; (iv) construction supervision; (v) management and related services; and (vi) other technical services or special studies. (2016 revised IRR, Section 5[i])

Contract – Refers to the agreement entered into between the Procuring Entity and the Supplier or Manufacturer or Distributor or Service Provider for procurement of Goods and Services; Contractor for Procurement of Infrastructure Projects; or Consultant or Consulting Firm for Procurement of Consulting Services; as the case may be, as recorded in the Contract Form signed by the parties, including all attachments and appendices thereto and all documents incorporated by reference therein.

Contractor – is a natural or juridical entity whose proposal was accepted by the Procuring Entity and to whom the Contract to execute the Work was awarded. Contractor as used in these Bidding Documents may likewise refer to a supplier, distributor, manufacturer, or consultant.

CPI – Consumer Price Index.

DOLE – Department of Labor and Employment.

DTI – Department of Trade and Industry.

Foreign-funded Procurement or Foreign-Assisted Project – Refers to procurement whose funding source is from a foreign government, foreign or international financing institution as specified in the Treaty or International or Executive Agreement. (2016 revised IRR, Section 5[b]).

GFI – Government Financial Institution.

GOCC – Government-owned and/or –controlled corporation.

Goods – Refer to all items, supplies, materials and general support services, except Consulting Services and Infrastructure Projects, which may be needed in the transaction of public businesses or in the pursuit of any government undertaking, project or activity, whether in the nature of equipment, furniture, stationery, materials for construction, or personal property of any kind, including non-personal or contractual services such as the repair and maintenance of equipment and furniture, as well as trucking, hauling, janitorial, security, and related or analogous services, as well as procurement of materials and supplies provided by the Procuring Entity for such services. The term “related” or “analogous services” shall include, but is not limited to, lease or purchase of office space, media advertisements, health maintenance services, and other services essential to the operation of the Procuring Entity. (2016 revised IRR, Section 5[r])

GOP – Government of the Philippines.

Infrastructure Projects – Include the construction, improvement, rehabilitation, demolition, repair, restoration or maintenance of roads and bridges, railways, airports, seaports, communication facilities, civil works components of information technology projects, irrigation, flood control and drainage, water supply, sanitation, sewerage and solid waste management systems, shore protection, energy/power and electrification facilities, national buildings, school buildings, hospital buildings, and other related construction projects of the government. Also referred to as *civil works or works*. (2016 revised IRR, Section 5[u])

LGUs – Local Government Units.

NFCC – Net Financial Contracting Capacity.

NGA – National Government Agency.

PCAB – Philippine Contractors Accreditation Board.

PhilGEPS - Philippine Government Electronic Procurement System.

Procurement Project – refers to a specific or identified procurement covering goods, infrastructure project or consulting services. A Procurement Project shall be described, detailed, and scheduled in the Project Procurement Management Plan prepared by the agency which shall be consolidated in the procuring entity's Annual Procurement Plan. (GPPB Circular No. 06-2019 dated 17 July 2019)

PSA – Philippine Statistics Authority.

SEC – Securities and Exchange Commission.

SLCC – Single Largest Completed Contract.

UN – United Nations.

Section I. Invitation to Bid



Republic of the Philippines
PROVINCE OF CAMARINES NORTE
BIDS AND AWARDS COMMITTEE



Invitation to Bid for the Establishment of Provincial Emergency Operations Center (EOC) – Phase I, Provincial Capitol Building, Daet, Camarines Norte

1. The *Provincial Government of Camarines Norte*, through the *PDRRMO – Special Trust Fund (Unutilized/Unexpended MOOE/QRF of LDRRMF 2022)* intends to apply the sum of *Nine Million Five Hundred Forty-Six Thousand Five Hundred Seventy-Six Pesos (P9,546,576.00)* being the Approved Budget for the Contract (ABC) to payments under the contract for the *Establishment of Provincial Emergency Operations Center (EOC) – Phase I, Provincial Capitol Building, Daet, Camarines Norte*. Bids received in excess of the ABC shall be automatically rejected at bid opening.
2. The *Provincial Government of Camarines Norte* now invites bids for the *Renovations and Constructions of Rooms Allocated for Emergency Operations Center (EOC) and Magnetic Door Access Control with Biometrics and Rack Components of Server*. Completion of the Works is required *120 CD*. Bidders should have completed a contract similar to the Project. The description of an eligible bidder is contained in the Bidding Documents, particularly, in Section II (Instructions to Bidders).
3. Bidding will be conducted through open competitive bidding procedures using non-discretionary “pass/fail” criterion as specified in the 2016 Revised Implementing Rules and Regulations (IRR) of Republic Act 9184 (RA 9184), otherwise known as the “Government Procurement Reform Act.”
4. Bidders may obtain further information from the *Provincial Government of Camarines Norte* and inspect the Bidding Documents at the address given below from *8:00a.m. to 5:00p.m., Monday to Friday*.
5. A complete set of Bidding Documents may be acquired by interested bidders *April 2 – April 25, 2024* at the *Provincial Capitol Building, Daet, Camarines Norte* and from the website of the *Philippine Government Electronic Procurement System (PhilGEPS)* upon payment of the applicable fee for the Bidding Documents, pursuant to the latest Guidelines issued by the GPPB, in the amount of *Ten Thousand Pesos (P10,000.00)*. The Procuring Entity shall allow the bidder to present its proof of payment for the fees in person.
6. The *Provincial Government of Camarines Norte* will hold a Pre-Bid Conference on *April 11, 2024, 2:00p.m.* at the *new BAC Conference Office, at the back of Agro-Sports Center, J. Lukban Street, Daet, Camarines Norte*, which shall be open to prospective bidders.
7. Bids must be duly received by the BAC Secretariat at the address below on or before *April 25, 2024 at 1:30p.m.* Late bids shall not be accepted.
8. All bids must be accompanied by a bid security in any of the acceptable forms and in the amount stated in ITB Clause 16.
9. Bid opening shall be on *April 25, 2024, 2:00 p.m.* at the *new BAC Conference Office, at the back of Agro-Sports Center, J. Lukban Street, Daet, Camarines Norte*. Bids will be opened in the presence of the bidders’ representatives who choose to attend the activity.

10. The *Provincial Government of Camarines Norte* reserves the right to reject any and all bids, declare a failure of bidding, or not award the contract at any time prior to contract award in accordance with Section 35.6 and 41 of RA 9184 of the revised IRR of RA 9184 without thereby incurring any liability to the affected bidder or bidders.

11. For further information, please refer to:

ATTY. ARCHIMEDES O. YANTO
Provincial Legal Officer / BAC Chairperson
Provincial Capitol Bldg., Daet, Camarines Norte
(054) 885-1474

12. You may visit the website:

Philippine Government Electronic Procurement System (PhilGEPS)

ATTY. ARCHIMEDES O. YANTO
Provincial Legal Officer / BAC Chairperson

Section II. Instructions to Bidders

1. Scope of Bid

The Procuring Entity, *[indicate name]* invites Bids for the *[insert Procurement Project]*, with Project Identification Number *[indicate number]*.

[Note: The Project Identification Number is assigned by the Procuring Entity based on its own coding scheme and is not the same as the PhilGEPS reference number, which is generated after the posting of the bid opportunity on the PhilGEPS website.]

The Procurement Project (referred to herein as “Project”) is for the construction of Works, as described in Section VI (Specifications).

2. Funding Information

2.1. The GOP through the source of funding as indicated below for *[indicate funding year]* in the amount of *[indicate amount]*.

2.2. The source of funding is:

[If an early procurement activity, select one and delete others:]

- a. NGA, the National Expenditure Program.
- b. GOCC and GFIs, the proposed Corporate Operating Budget.
- c. LGUs, the proposed Local Expenditure Program.

[If not an early procurement activity, select one and delete others:]

- a. NGA, the General Appropriations Act or Special Appropriations.
- b. GOCC and GFIs, the Corporate Operating Budget.
- c. LGUs, the Annual or Supplemental Budget, as approved by the Sanggunian.

3. Bidding Requirements

The Bidding for the Project shall be governed by all the provisions of RA No. 9184 and its 2016 revised IRR, including its Generic Procurement Manual and associated policies, rules and regulations as the primary source thereof, while the herein clauses shall serve as the secondary source thereof.

Any amendments made to the IRR and other GPPB issuances shall be applicable only to the ongoing posting, advertisement, or invitation to bid by the BAC through the issuance of a supplemental or bid bulletin.

The Bidder, by the act of submitting its Bid, shall be deemed to have inspected the site, determined the general characteristics of the contracted Works and the conditions for this Project, such as the location and the nature of the work; (b) climatic conditions; (c) transportation facilities; (c) nature and condition of the terrain, geological conditions

at the site communication facilities, requirements, location and availability of construction aggregates and other materials, labor, water, electric power and access roads; and (d) other factors that may affect the cost, duration and execution or implementation of the contract, project, or work and examine all instructions, forms, terms, and project requirements in the Bidding Documents.

4. Corrupt, Fraudulent, Collusive, Coercive, and Obstructive Practices

The Procuring Entity, as well as the Bidders and Contractors, shall observe the highest standard of ethics during the procurement and execution of the contract. They or through an agent shall not engage in corrupt, fraudulent, collusive, coercive, and obstructive practices defined under Annex “I” of the 2016 revised IRR of RA No. 9184 or other integrity violations in competing for the Project.

5. Eligible Bidders

5.1. Only Bids of Bidders found to be legally, technically, and financially capable will be evaluated.

5.2. The Bidder must have an experience of having completed a Single Largest Completed Contract (SLCC) that is similar to this Project, equivalent to at least fifty percent (50%) of the ABC adjusted, if necessary, by the Bidder to current prices using the PSA’s CPI, except under conditions provided for in Section 23.4.2.4 of the 2016 revised IRR of RA No. 9184.

A contract is considered to be “similar” to the contract to be bid if it has the major categories of work stated in the **BDS**.

5.3. For Foreign-funded Procurement, the Procuring Entity and the foreign government/foreign or international financing institution may agree on another track record requirement, as specified in the Bidding Document prepared for this purpose.

5.4. The Bidders shall comply with the eligibility criteria under Section 23.4.2 of the 2016 IRR of RA No. 9184.

6. Origin of Associated Goods

There is no restriction on the origin of Goods other than those prohibited by a decision of the UN Security Council taken under Chapter VII of the Charter of the UN.

7. Subcontracts

7.1. The Bidder may subcontract portions of the Project to the extent allowed by the Procuring Entity as stated herein, but in no case more than fifty percent (50%) of the Project.

The Procuring Entity has prescribed that:
[Select one, delete other/s]

- a. Subcontracting is allowed. The portions of Project and the maximum percentage allowed to be subcontracted are indicated in the **BDS**, which shall not exceed fifty percent (50%) of the contracted Works.
 - b. Subcontracting is not allowed.
- 7.1. *[If Procuring Entity has determined that subcontracting is allowed during the bidding , state:]* The Bidder must submit together with its Bid the documentary requirements of the subcontractor(s) complying with the eligibility criteria stated in **ITB** Clause 5 in accordance with Section 23.4 of the 2016 revised IRR of RA No. 9184 pursuant to Section 23.1 thereof.
- 7.2. *[If subcontracting is allowed during the contract implementation stage, state:]* The Supplier may identify its subcontractor during the contract implementation stage. Subcontractors identified during the bidding may be changed during the implementation of this Contract. Subcontractors must submit the documentary requirements under Section 23.1 of the 2016 revised IRR of RA No. 9184 and comply with the eligibility criteria specified in **ITB** Clause 5 to the implementing or end-user unit.
- 7.3. Subcontracting of any portion of the Project does not relieve the Contractor of any liability or obligation under the Contract. The Supplier will be responsible for the acts, defaults, and negligence of any subcontractor, its agents, servants, or workmen as fully as if these were the Contractor's own acts, defaults, or negligence, or those of its agents, servants, or workmen.

8. Pre-Bid Conference

The Procuring Entity will hold a pre-bid conference for this Project on the specified date and time and either at its physical address *{[insert if applicable]}* and/or through videoconferencing/webcasting} as indicated in paragraph 6 of the **IB**.

9. Clarification and Amendment of Bidding Documents

Prospective bidders may request for clarification on and/or interpretation of any part of the Bidding Documents. Such requests must be in writing and received by the Procuring Entity, either at its given address or through electronic mail indicated in the **IB**, at least ten (10) calendar days before the deadline set for the submission and receipt of Bids.

10. Documents Comprising the Bid: Eligibility and Technical Components

- 10.1. The first envelope shall contain the eligibility and technical documents of the Bid as specified in **Section IX. Checklist of Technical and Financial Documents**.
- 10.2. If the eligibility requirements or statements, the bids, and all other documents for submission to the BAC are in foreign language other than English, it must

be accompanied by a translation in English, which shall be authenticated by the appropriate Philippine foreign service establishment, post, or the equivalent office having jurisdiction over the foreign bidder's affairs in the Philippines. For Contracting Parties to the Apostille Convention, only the translated documents shall be authenticated through an apostille pursuant to GPPB Resolution No. 13-2019 dated 23 May 2019. The English translation shall govern, for purposes of interpretation of the bid.

- 10.3. A valid PCAB License is required, and in case of joint ventures, a valid special PCAB License, and registration for the type and cost of the contract for this Project. Any additional type of Contractor license or permit shall be indicated in the **BDS**.
- 10.4. A List of Contractor's key personnel (e.g., Project Manager, Project Engineers, Materials Engineers, and Foremen) assigned to the contract to be bid, with their complete qualification and experience data shall be provided. These key personnel must meet the required minimum years of experience set in the **BDS**.
- 10.5. A List of Contractor's major equipment units, which are owned, leased, and/or under purchase agreements, supported by proof of ownership, certification of availability of equipment from the equipment lessor/vendor for the duration of the project, as the case may be, must meet the minimum requirements for the contract set in the **BDS**.

11. Documents Comprising the Bid: Financial Component

- 11.1. The second bid envelope shall contain the financial documents for the Bid as specified in **Section IX. Checklist of Technical and Financial Documents**.
- 11.2. Any bid exceeding the ABC indicated in paragraph 1 of the **IB** shall not be accepted.
- 11.3. For Foreign-funded procurement, a ceiling may be applied to bid prices provided the conditions are met under Section 31.2 of the 2016 revised IRR of RA No. 9184.

12. Alternative Bids

Bidders shall submit offers that comply with the requirements of the Bidding Documents, including the basic technical design as indicated in the drawings and specifications. Unless there is a value engineering clause in the **BDS**, alternative Bids shall not be accepted.

13. Bid Prices

All bid prices for the given scope of work in the Project as awarded shall be considered as fixed prices, and therefore not subject to price escalation during contract implementation, except under extraordinary circumstances as determined by the NEDA and approved by the GPPB pursuant to the revised Guidelines for Contract Price Escalation guidelines.

14. Bid and Payment Currencies

14.1. Bid prices may be quoted in the local currency or tradeable currency accepted by the BSP at the discretion of the Bidder. However, for purposes of bid evaluation, Bids denominated in foreign currencies shall be converted to Philippine currency based on the exchange rate as published in the BSP reference rate bulletin on the day of the bid opening.

14.2. *Payment of the contract price shall be made in:*

[Select one, delete other/s]

a. Philippine Pesos.

b. *[indicate currency if procurement involves a foreign-denominated bid as allowed by the Procuring Entity, which shall be tradeable or acceptable by the BSP.]*

15. Bid Security

15.1. The Bidder shall submit a Bid Securing Declaration or any form of Bid Security in the amount indicated in the **BDS**, which shall be not less than the percentage of the ABC in accordance with the schedule in the **BDS**.

15.2. The Bid and bid security shall be valid until *[indicate date]*. Any bid not accompanied by an acceptable bid security shall be rejected by the Procuring Entity as non-responsive.

16. Sealing and Marking of Bids

Each Bidder shall submit one copy of the first and second components of its Bid.

The Procuring Entity may request additional hard copies and/or electronic copies of the Bid. However, failure of the Bidders to comply with the said request shall not be a ground for disqualification.

If the Procuring Entity allows the submission of bids through online submission to the given website or any other electronic means, the Bidder shall submit an electronic copy of its Bid, which must be digitally signed. An electronic copy that cannot be opened or is corrupted shall be considered non-responsive and, thus, automatically disqualified.

17. Deadline for Submission of Bids

The Bidders shall submit on the specified date and time and either at its physical address or through online submission as indicated in paragraph 7 of the **IB**.

18. Opening and Preliminary Examination of Bids

- 18.1. The BAC shall open the Bids in public at the time, on the date, and at the place specified in paragraph 9 of the **IB**. The Bidders' representatives who are present shall sign a register evidencing their attendance. In case videoconferencing, webcasting or other similar technologies will be used, attendance of participants shall likewise be recorded by the BAC Secretariat.

In case the Bids cannot be opened as scheduled due to justifiable reasons, the rescheduling requirements under Section 29 of the 2016 revised IRR of RA No. 9184 shall prevail.

- 18.2. The preliminary examination of Bids shall be governed by Section 30 of the 2016 revised IRR of RA No. 9184.

19. Detailed Evaluation and Comparison of Bids

- 19.1. The Procuring Entity's BAC shall immediately conduct a detailed evaluation of all Bids rated "*passed*" using non-discretionary pass/fail criteria. The BAC shall consider the conditions in the evaluation of Bids under Section 32.2 of 2016 revised IRR of RA No. 9184.
- 19.2. If the Project allows partial bids, all Bids and combinations of Bids as indicated in the **BDS** shall be received by the same deadline and opened and evaluated simultaneously so as to determine the Bid or combination of Bids offering the lowest calculated cost to the Procuring Entity. Bid Security as required by **ITB** Clause 16 shall be submitted for each contract (lot) separately.
- 19.3. In all cases, the NFCC computation pursuant to Section 23.4.2.6 of the 2016 revised IRR of RA No. 9184 must be sufficient for the total of the ABCs for all the lots participated in by the prospective Bidder.

20. Post Qualification

Within a non-extendible period of five (5) calendar days from receipt by the Bidder of the notice from the BAC that it submitted the Lowest Calculated Bid, the Bidder shall submit its latest income and business tax returns filed and paid through the BIR Electronic Filing and Payment System (eFPS), and other appropriate licenses and permits required by law and stated in the **BDS**.

21. Signing of the Contract

The documents required in Section 37.2 of the 2016 revised IRR of RA No. 9184 shall form part of the Contract. Additional Contract documents are indicated in the **BDS**.

Section III. Bid Data Sheet

Bid Data Sheet

ITB Clause																			
5.2	For this purpose, contracts similar to the Project refer to contracts which have the same major categories of work, which shall be: <i>Building Construction/Renovation</i>																		
7.1	<i>Subcontracting is not allowed.</i>																		
10.3	<i>No further instructions.</i>																		
10.4	The key personnel must meet the required minimum years of experience set below: <table border="1" style="width: 100%; border-collapse: collapse;"> <thead> <tr> <th style="text-align: left;"><u>Key Personnel</u></th> <th style="text-align: center;"><u>General Experience</u></th> <th style="text-align: center;"><u>Relevant Experience</u></th> </tr> </thead> <tbody> <tr> <td>Project Manager</td> <td style="text-align: center;">one (1)</td> <td style="text-align: center;">one (1)</td> </tr> <tr> <td>Project Engineer</td> <td style="text-align: center;">one (1)</td> <td style="text-align: center;">one (1)</td> </tr> <tr> <td>Materials Engineer</td> <td style="text-align: center;">one (1)</td> <td style="text-align: center;">one (1)</td> </tr> <tr> <td>Electrical Engineer</td> <td style="text-align: center;">one (1)</td> <td style="text-align: center;">one (1)</td> </tr> <tr> <td>Mechanical Engineer</td> <td style="text-align: center;">one (1)</td> <td style="text-align: center;">one (1)</td> </tr> </tbody> </table>	<u>Key Personnel</u>	<u>General Experience</u>	<u>Relevant Experience</u>	Project Manager	one (1)	one (1)	Project Engineer	one (1)	one (1)	Materials Engineer	one (1)	one (1)	Electrical Engineer	one (1)	one (1)	Mechanical Engineer	one (1)	one (1)
<u>Key Personnel</u>	<u>General Experience</u>	<u>Relevant Experience</u>																	
Project Manager	one (1)	one (1)																	
Project Engineer	one (1)	one (1)																	
Materials Engineer	one (1)	one (1)																	
Electrical Engineer	one (1)	one (1)																	
Mechanical Engineer	one (1)	one (1)																	
10.5	The minimum major equipment requirements are the following: <table border="1" style="width: 100%; border-collapse: collapse;"> <thead> <tr> <th style="text-align: left;"><u>Equipment</u></th> <th style="text-align: center;"><u>Capacity</u></th> <th style="text-align: center;"><u>Number of Units</u></th> </tr> </thead> <tbody> <tr> <td style="text-align: left;">1. Welding machine</td> <td></td> <td style="text-align: center;">1</td> </tr> </tbody> </table>	<u>Equipment</u>	<u>Capacity</u>	<u>Number of Units</u>	1. Welding machine		1												
<u>Equipment</u>	<u>Capacity</u>	<u>Number of Units</u>																	
1. Welding machine		1																	
12	<i>Not Applicable</i>																		
15.1	The bid security shall be in the form of a Bid Securing Declaration or any of the following forms and amounts: a. The amount of not less than <u>PhP 191,000.00</u> , if bid security is in cash, cashier's/manager's check, bank draft/guarantee or irrevocable letter of credit; b. The amount of not less than <u>PhP 477,500.00</u> if bid security is in Surety Bond.																		
19.2	<i>Not Applicable</i>																		
20	<i>No further instructions.</i>																		
21	Additional contract documents relevant to the Project that may be required by existing laws and/or the Procuring Entity, such as Affidavit of Site Inspection, Affidavit of Availability of Key Personnel and Equipment, PERT/CPM, Construction Schedule and S- curve, Manpower Utilization Schedule, Construction Methods, Equipment Utilization Schedule, Construction Safety and Health Program approved by the DOLE, and other acceptable tools of project scheduling.																		

Section IV. General Conditions of Contract

1. **Scope of Contract**

This Contract shall include all such items, although not specifically mentioned, that can be reasonably inferred as being required for its completion as if such items were expressly mentioned herein. All the provisions of RA No. 9184 and its 2016 revised IRR, including the Generic Procurement Manual, and associated issuances, constitute the primary source for the terms and conditions of the Contract, and thus, applicable in contract implementation. Herein clauses shall serve as the secondary source for the terms and conditions of the Contract.

This is without prejudice to Sections 74.1 and 74.2 of the 2016 revised IRR of RA No. 9184 allowing the GPPB to amend the IRR, which shall be applied to all procurement activities, the advertisement, posting, or invitation of which were issued after the effectivity of the said amendment.

2. **Sectional Completion of Works**

If sectional completion is specified in the **Special Conditions of Contract (SCC)**, references in the Conditions of Contract to the Works, the Completion Date, and the Intended Completion Date shall apply to any Section of the Works (other than references to the Completion Date and Intended Completion Date for the whole of the Works).

3. **Possession of Site**

4.1. The Procuring Entity shall give possession of all or parts of the Site to the Contractor based on the schedule of delivery indicated in the **SCC**, which corresponds to the execution of the Works. If the Contractor suffers delay or incurs cost from failure on the part of the Procuring Entity to give possession in accordance with the terms of this clause, the Procuring Entity's Representative shall give the Contractor a Contract Time Extension and certify such sum as fair to cover the cost incurred, which sum shall be paid by Procuring Entity.

4.2. If possession of a portion is not given by the above date, the Procuring Entity will be deemed to have delayed the start of the relevant activities. The resulting adjustments in contract time to address such delay may be addressed through contract extension provided under Annex "E" of the 2016 revised IRR of RA No. 9184.

4. **The Contractor's Obligations**

The Contractor shall employ the key personnel named in the Schedule of Key Personnel indicating their designation, in accordance with **ITB** Clause 10.3 and specified in the **BDS**, to carry out the supervision of the Works.

The Procuring Entity will approve any proposed replacement of key personnel only if their relevant qualifications and abilities are equal to or better than those of the personnel listed in the Schedule.

5. Performance Security

- 5.1. Within ten (10) calendar days from receipt of the Notice of Award from the Procuring Entity but in no case later than the signing of the contract by both parties, the successful Bidder shall furnish the performance security in any of the forms prescribed in Section 39 of the 2016 revised IRR.
- 5.2. The Contractor, by entering into the Contract with the Procuring Entity, acknowledges the right of the Procuring Entity to institute action pursuant to RA No. 3688 against any subcontractor be they an individual, firm, partnership, corporation, or association supplying the Contractor with labor, materials and/or equipment for the performance of this Contract.

6. Site Investigation Reports

The Contractor, in preparing the Bid, shall rely on any Site Investigation Reports referred to in the SCC supplemented by any information obtained by the Contractor.

7. Warranty

- 7.1. In case the Contractor fails to undertake the repair works under Section 62.2.2 of the 2016 revised IRR, the Procuring Entity shall forfeit its performance security, subject its property(ies) to attachment or garnishment proceedings, and perpetually disqualify it from participating in any public bidding. All payables of the GOP in his favor shall be offset to recover the costs.
- 7.2. The warranty against Structural Defects/Failures, except that occasioned-on force majeure, shall cover the period from the date of issuance of the Certificate of Final Acceptance by the Procuring Entity. Specific duration of the warranty is found in the SCC.

8. Liability of the Contractor

Subject to additional provisions, if any, set forth in the SCC, the Contractor's liability under this Contract shall be as provided by the laws of the Republic of the Philippines.

If the Contractor is a joint venture, all partners to the joint venture shall be jointly and severally liable to the Procuring Entity.

9. Termination for Other Causes

Contract termination shall be initiated in case it is determined *prima facie* by the Procuring Entity that the Contractor has engaged, before, or during the implementation of the contract, in unlawful deeds and behaviors relative to contract acquisition and implementation, such as, but not limited to corrupt, fraudulent, collusive, coercive, and obstructive practices as stated in ITB Clause 4.

10. Dayworks

Subject to the guidelines on Variation Order in Annex “E” of the 2016 revised IRR of RA No. 9184, and if applicable as indicated in the **SCC**, the Dayworks rates in the Contractor’s Bid shall be used for small additional amounts of work only when the Procuring Entity’s Representative has given written instructions in advance for additional work to be paid for in that way.

11. Program of Work

11.1. The Contractor shall submit to the Procuring Entity’s Representative for approval the said Program of Work showing the general methods, arrangements, order, and timing for all the activities in the Works. The submissions of the Program of Work are indicated in the **SCC**.

11.2. The Contractor shall submit to the Procuring Entity’s Representative for approval an updated Program of Work at intervals no longer than the period stated in the **SCC**. If the Contractor does not submit an updated Program of Work within this period, the Procuring Entity’s Representative may withhold the amount stated in the **SCC** from the next payment certificate and continue to withhold this amount until the next payment after the date on which the overdue Program of Work has been submitted.

12. Instructions, Inspections and Audits

The Contractor shall permit the GOP or the Procuring Entity to inspect the Contractor’s accounts and records relating to the performance of the Contractor and to have them audited by auditors of the GOP or the Procuring Entity, as may be required.

13. Advance Payment

The Procuring Entity shall, upon a written request of the Contractor which shall be submitted as a Contract document, make an advance payment to the Contractor in an amount not exceeding fifteen percent (15%) of the total contract price, to be made in lump sum, or at the most two installments according to a schedule specified in the **SCC**, subject to the requirements in Annex “E” of the 2016 revised IRR of RA No. 9184.

14. Progress Payments

The Contractor may submit a request for payment for Work accomplished. Such requests for payment shall be verified and certified by the Procuring Entity’s Representative/Project Engineer. Except as otherwise stipulated in the **SCC**, materials and equipment delivered on the site but not completely put in place shall not be included for payment.

15. Operating and Maintenance Manuals

15.1. If required, the Contractor will provide “as built” Drawings and/or operating and maintenance manuals as specified in the **SCC**.

- 15.2. If the Contractor does not provide the Drawings and/or manuals by the dates stated above, or they do not receive the Procuring Entity's Representative's approval, the Procuring Entity's Representative may withhold the amount stated in the SCC from payments due to the Contractor.

Section V. Special Conditions of Contract

Special Conditions of Contract

GCC Clause	
2	<i>Not Applicable</i>
3.1	<i>upon receipt of the Notice to Proceed</i>
6	The site investigation reports are: <i>Present condition of the actual project site</i>
7.2	<i>[In case of permanent structures, such as buildings of types 4 and 5 as classified under the National Building Code of the Philippines and other structures made of steel, iron, or concrete which comply with relevant structural codes (e.g., DPWH Standard Specifications), such as, but not limited to, steel/concrete bridges, flyovers, aircraft movement areas, ports, dams, tunnels, filtration and treatment plants, sewerage systems, power plants, transmission and communication towers, railway system, and other similar permanent structures:] Fifteen (15) years.</i>
10	Dayworks are applicable at the rate shown in the Contractor's original Bid.
11.1	The Contractor shall submit the Program of Work to the Procuring Entity's Representative within 5 <i>working days</i> of delivery of the Notice of Award.
11.2	The period between Program of Work updates is thirty (30) days. The amount to be withheld for late submission of an updated Program of Work is 1% of progress billing.
13	The amount of the advance payment is <i>15% of the total contract price.</i>
14	<i>Materials and equipment delivered on the site but not completely put in place shall NOT be included for payment.</i>
15.1	The date by which "as built" drawings are required is 15-30 days upon completion date.
15.2	The amount to be withheld for failing to produce "as built" drawings by the date required is 1% of the final contract amount in Philippine pesos.

Section VI. Specifications

ITEM 101 – REMOVAL OF STRUCTURES AND OBSTRUCTIONS

101.1 Description

This Item shall consist of the removal wholly or in part, and satisfactory disposal of all buildings, fences, structures, old pavements, abandoned pipe lines, and any other obstructions which are not designated or permitted to remain, except for the obstructions to be removed and disposed off under other items in the Contract. It shall also include the salvaging of designated materials and backfilling the resulting trenches, holes, and pits.

101.2 Construction Requirements

101.2.1 General

The Contractor shall perform the work described above, within and adjacent to the roadway, on Government land or easement, as shown on the Plans or as directed by the Engineer. All designated salvable material shall be removed, without unnecessary damage, in sections or pieces which may be readily transported, and shall be stored by the Contractor at specified places on the project or as otherwise shown in the Special Provisions. Perishable material shall be handled as designated in Subsection 100.2.2 Nonperishable material may be disposed off outside the limits of view from the project with written permission of the property owner on whose property the material is placed. Copies of all agreements with property owners are to be furnished to the Engineer. Basements or cavities left by the structure removal shall be filled with acceptable material to the level of the surrounding ground and, if within the prism of construction, shall be compacted to the required density.

101.2.2 Removal of Existing Bridges, Culverts, and other Drainage Structures

All existing bridges, culverts and other drainage structures in use by traffic shall not be removed until satisfactory arrangements have been made to accommodate traffic. The removal of existing culverts within embankment areas will be required only as necessary for the installation of new structures. Abandoned culverts shall be broken down, crushed and sealed or plugged. All retrieved culvert for future use as determined by the Engineer shall be carefully removed and all precautions shall be employed to avoid breakage or structural damage to any of its part. All sections of structures removed which are not designated for stockpiling or re-laying shall become the property of the Government and be removed from the project or disposed off in a manner approved by the Engineer.

Unless otherwise directed, the substructures of existing structures shall be removed down to the natural stream bottom and those parts outside of the stream shall be removed down to at least 300 mm (12 inches) below natural ground surface. Where such portions of existing structures lie wholly or in part within the limits for a new structure, they shall be removed as necessary to accommodate the construction of the proposed structure.

Steel bridges and wood bridges when specified to be salvaged shall be carefully dismantled without damaged. Steel members shall be match marked unless such match marking is waived by the Engineer. All salvaged material shall be stored as specified in Subsection 101.2.1. Structures designated to become the property of the Contractor shall be removed from the right-of-way.

Blasting or other operations necessary for the removal of an existing structure or obstruction, which may damage new construction, shall be completed prior to placing the new work, unless otherwise provided in the Special Provisions.

101.2.3 Removal of Pipes Other than Pipe Culverts

Unless otherwise provided, all pipes shall be carefully removed and every precaution taken to avoid breakage or damaged. Pipes to be relaid shall be removed and stored when necessary so that there will be no loss of damage before re-laying. The Contractor shall replace sections lost from storage or damage by negligence, at his own expense.

101.2.4 Removal of Existing Pavement, Sidewalks, Curbs, etc.

All concrete pavement, base course, sidewalks, curbs, gutters, etc., designated for removal, shall be:

- (1) Broken into pieces and used for riprap on the project, or
- (2) Broken into pieces, the size of which shall not exceed 300 mm (12 inches) in any dimension and stockpiled at designated locations on the project for use by the Government, or
- (3) Otherwise demolished and disposed off as directed by the Engineer. When specified, ballast, gravel, bituminous materials or other surfacing or pavement materials shall be removed and stockpiled as required in Subsection 101.2.1, otherwise such materials shall be disposed off as directed.

There will be no separate payment for excavating for removal of structures and obstructions or for backfilling and compacting the remaining cavity.

101.3 Method of Measurement

When the Contract stipulates that payment will be made for removal of obstructions on lump-sum basis, the pay item will include all structures and obstructions encountered within the roadway. Where the contract stipulates that payment will be made for the removal of specific items on a unit basis, measurement will be made by the unit stipulated in the Contract.

Whenever the Bill of Quantities does not contain an item for any aforementioned removals, the work will not be paid for directly, but will be considered as a subsidiary obligation of the Contractor under other Contract Items.

101.4 Basis of Payment

The accepted quantities, measured as prescribed in Section 101.3, shall be paid for at the Contract unit price or lump sum price bid for each of the Pay Items listed below that is included in the Bill of Quantities which price and payment shall be full compensation for removing and disposing of obstructions, including materials, labor, equipments, tools and incidentals necessary to complete the work prescribed in this Item. The price shall also include backfilling, salvage of materials removed, their custody, preservation, storage on the right-of-way and disposal as provided herein.

Payment will be made under:

Pay Item Number	Description	Unit of Measurement
101 (1)	Removal of Structures and Obstruction	Lump Sum
101 (2)	Removal of	Each
101 (3)	Removal of	Square Meter
101 (4)	Removal of	Linear Meter

ITEM 404 – REINFORCING STEEL

404.1 Description

This Item shall consist of furnishing, bending, fabricating and placing of steel reinforcement of the type, size, shape and grade required in accordance with this Specification and in conformity with the requirements shown on the Plans or as directed by the Engineer.

404.2 Material Requirements

Reinforcing steel shall meet the requirements of item 710, Reinforcing Steel and Wire Rope.

4.4.3 Construction Requirements

404.3.1 Order Lists

Before materials are ordered, all order lists and bending diagrams shall be furnished by the Contractor, for approval of the Engineer. The approval of order lists and bending diagrams by the Engineer shall in no way relieve the Contractor of responsibility for the correctness of such lists and diagrams. Any expense incident to the revisions of materials furnished in accordance with such lists and diagrams to make them comply with the Plans shall be borne by the Contractor.

404.3.2 Protection of Material

Steel reinforcement shall be stored above the surface of the ground upon platforms, skids, or other supports and shall be protected as far as practicable from mechanical injury and surface deterioration caused by exposure to conditions producing rust. When placed in the work, reinforcement shall be free from dirt, detrimental rust, loose scale, paint, grease, oil, or other foreign materials. Reinforcement shall be free from injurious defects such as cracks and

laminations. Rust, surface seams, surface irregularities or mill scale will not be cause for rejection, provided the minimum dimensions, cross sectional area and tensile properties of a hand wire brushed specimen meets the physical requirements for the size and grade of steel specified.

404.3.3 Bending

All reinforcing bars requiring bending shall be cold-bent to the shapes shown on the Plans or required by the Engineer. Bars shall be bent around a circular pin having the following diameters (D) in relation to the diameter of the bar (d):

Nominal diameter, d, mm	Pin diameter (D)
10 to 20	6d
25 to 28	8d
32 and greater	10d

Bends and hooks in stirrups or ties may be bent to the diameter of the principal bar enclosed therein.

404.3.4 Placing and Fastening

All steel reinforcement shall be accurately placed in the position shown on the Plans or required by the Engineer and firmly held there during the placing and setting of the concrete. Bars shall be tied at all intersections except where spacing is less than 300mm in each directions, in which case, alternate intersections shall be tied. Ties shall be fastened on the inside.

Distance from the forms shall be maintained by means of stays, blocks, ties, hangers, or other approved supports, so that it does not vary from the position indicated on the Plans by more than 6mm. Blocks for holding reinforcement from contact with the forms shall be precast mortar blocks of approved shapes and dimensions. Layers of bars shall be separated by precast mortar blocks or by other equally suitable devices. The use of pebbles, pieces of broken stone or brick, metal pipe and wooden blocks shall not be permitted. Unless otherwise shown on the Plans or required by the Engineer, the minimum distance between bars shall be 40mm. Reinforcement in any member shall be placed and then inspected and approved by the Engineer before the placing of concrete begins. Concrete placed in violation of this provision may be rejected and removal may be required. If fabric reinforcement is shipped in rolls, it shall be straightened before being placed. Bundled bars shall be tied together at not more than 1.8m intervals.

404.3.5 Splicing

All reinforcement shall be furnished in the full lengths indicated on the Plans. Splicing of bars, except where shown on the Plans, will not be permitted without the written approval of the Engineer. Splices shall be staggered as far as possible and with a minimum separation of not less than 40 bar diameters. Not more than one-third of the bars may be spliced in the same cross-section, except where shown on the Plans.

Unless otherwise shown on the Plans, bars shall be lapped a minimum distance of:

Splice Type	Grade 40 min. lap	Grade 60 min. lap	But not less than
Tension	24 bar dia	36 bar dia	300 mm
Compression	20 bar dia	24 bar dia	300 mm

In lapped splices, the bars shall be placed in contact and wired together. Lapped splices will not be permitted at locations where the concrete section is insufficient to provide minimum clear distance of one and one-third the maximum size of coarse aggregate between the splice and the nearest adjacent bar. Welding of reinforcing steel shall be done only if detailed on the Plans or if authorized by the Engineer in writing. Spiral reinforcement shall be spliced by lapping at least one and a half turns or by butt welding unless otherwise shown on the Plans.

404.3.6 Lapping of Bar Mat

Sheets of mesh or bar mat reinforcement shall overlap each other sufficiently to maintain a uniform strength and shall be securely fastened at the ends and edges. The overlap shall not be less than one mesh in width.

404.4 Method of Measurement

The quantity of reinforcing steel to be paid for will be the final quantity placed and accepted in the completed structure.

No allowance will be made for tie-wires, separators, wire chairs and other material used in fastening the reinforcing steel in place. If bars are substituted upon the Contractor's request and approved by the Engineer and as a result thereof more steel is used than specified, only the mass specified shall be measured for payment.

No measurement or payment will be made for splices added by the Contractor unless directed or approved by the Engineer.

When there is no item for reinforcing steel in the Bill of Quantities, costs will be considered as incidental to the other items in the Bill of Quantities.

404.5 Basis of Payment

The accepted quantity, measured as prescribed in Section 404.4, shall be paid for at the contract unit price for Reinforcing Steel which price and payment shall be full compensation for furnishing and placing all materials, including all labor, equipment, tools and incidentals necessary to complete the work prescribed in this Item.

Payment will be made under:

Pay Item Number	Description	Unit of Measurement
404	Reinforcing Steel	Kilogram

ITEM 405 – STRUCTURAL CONCRETE

405.1 Description

405.1.1 Scope

This Item shall consist of furnishing, bending, placing and finishing concrete in all structures except pavements in accordance with this Specification and conforming to the lines, grades, and dimensions shown on the Plans. Concrete shall consist of a mixture of Portland Cement, fine aggregate, coarse aggregate, admixture when specified, and water mixed in the proportions specified or approved by the Engineer.

405.1.2 Classes and Uses of Concrete

Five classes of concrete are provided for in this Item, namely: A, B, C, P and Seal. Each class shall be used in that part of the structure as called for on the Plans.

The classes of concrete will generally be used as follows:

Class A – All superstructures and heavily reinforced substructures. The important parts of the structure included are slabs, beams, girders, columns, arch ribs, box culverts, reinforced abutments, retaining walls, and reinforced footings.

Class B – Footings, pedestals, massive pier shafts, pipe bedding, and gravity walls, unreinforced or with only a small amount of reinforcement.

Class C – Thin reinforced sections, railings, precast R.C. piles and cribbing and for filler in steel grid floors.

Class P – Prestressed concrete structures and members.

Seal – Concrete deposited in water.

405.2 Material Requirements

405.2.1 Portland Cement

It shall conform to all the requirements of Subsection 311.2.1.

405.2.2 Fine Aggregate

It shall conform to all the requirements of Subsection 311.2.2.

405.2.3 Coarse Aggregate

It shall conform all the requirements of Subsection 311.2.3 except that gradation shall conform to Table 405.1.

Table 405.1 – Grading Requirements for Coarse Aggregate

Sieve Designation		Mass Percent Passing				
Standard Mm	Alternate US Standard	Class A	Class B	Class C	Class P	Class Seal
63	2-1/2"		100			
50	2"	100	95 – 100			
37.5	1-1/2"	95 – 100	-			100

25	1"	-	35 – 70		100	95 – 100
19.0	¾"	35 – 70	-	100	95 – 100	-
12.5	½"	-	10 – 30	90 – 100	-	25 – 60
9.5	3/8"	10 – 30	-	40 – 70	20 – 55	-
4.75	No.4	0 - 5	0 - 5	0 – 15*	0 – 10*	0 – 10*

* The measured cement content shall be within plus (+) or minus (-) 2 mass percent of the design cement content.

405.2.4 Water

It shall conform to the requirements of Subsection 311.2.4

405.2.5 Reinforcing Steel

It shall conform to the requirements of Item 710, Reinforcing Steel and Wire Rope.

405.2.6 Admixtures

Admixtures shall conform to the requirements of Subsection 311.2.7

405.2.7 Curing Materials

Curing materials shall conform to the requirements of Subsection 311.2.8.

405.2.8 Expansion Joint Materials

Expansion joint materials shall be:

1. Preformed Sponge Rubber and Cork, conforming to AASHTO M 153.
2. Hot-Poured Elastic Type, conforming to AASHTO M 173.
3. Preformed Fillers, conforming to AASHTO M 213.

405.2.9 Elastomeric Compression Joint Seals

These shall conform to AASHTO M 220.

405.2.10 Elastomeric Bearing Pads

These shall conform to AASHTO M 251 or Item 412 – Elastomeric Bearing Pads.

405.2.11 Storage of Cement and Aggregates

Storage of cement and aggregates shall conform to all the requirements of Subsection 311.2.10.

405.3 Sampling and Testing of Structural Concrete

As work progresses, at least one (1) sample consisting of three (3) concrete cylinder test specimens, 150 x 300mm (6 x 12 inches), shall be taken from each seventy five (75) cubic meters of each class of concrete or fraction thereof placed each day.

Compliance with the requirements of this Section shall be determined in accordance with the following standard methods of AASHTO:

Sampling of fresh concrete	T 141
Weight per cubic metre and air content (gravi- Metric) of concrete	T 121
Sieve analysis of fine and coarse aggregates	T 27
Slump of Portland Cement Concrete	T 119
Specific gravity and absorption of fine aggregate	T 84

Tests for strength shall be made in accordance with the following:

Making and curing concrete compressive and flexural tests specimens in the field	T 23
Compressive strength of molded concrete Cylinders	T 22

405.4 Production Requirements

405.4.1 Proportioning and Strength of Structural Concrete

The concrete materials shall be proportioned in accordance with the requirements for each class of concrete as specified in Table 405.2, using the absolute volume method as outlined in the American Concrete Institute (ACI) Standard 211.1. "Recommended Practice for Selecting Proportions for Normal and Heavyweight Concrete". Other methods of proportioning may be employed in the mix design with prior approval of the Engineer. The mix shall either be designed or approved by the Engineer. A change in the source of materials during the progress of work may necessitate a new mix design.

The strength requirements for each class of concrete shall be as specified in Table 405.2.

Table 405.2 - Composition and Strength of Concrete for Use in Structures

Class Of Concrete	Minimum Cement Content Per m ³ kg (bag**)	Maximum Water/ Cement Ratio kg/kg	Consistency Range in Slump mm (inch)	Designated Size of Coarse Aggregate Square Opening Std. mm	Minimum Compressive Strength of 150x300mm Concrete Cylinder Specimen at 28 days, MN/m ² (psi)
A	360 (9 bags)	0.53	50 – 100 (2 – 4)	37.5 – 4.75 (1-1/2" – No. 4)	20.7 (3000)

B	320	0.58	50 – 100	50 – 4.75	16.5
	(8 bags)		(2 – 4)	(2” – No. 4)	(2400)
C	380	0.55	50 – 100	12.5 – 4.75	20.7
	(9.5 bags)		(2 – 4)	(1/2” – No. 4)	(3000)
P	440	0.49	100 max.	19.0 – 4.75	37.7
	(11 bags)		(4 max.)	(3/4” – No. 4)	(5000)
Seal	380	0.58	100 – 200	25 – 4.75	20.7
	(9.5 bags)		(4 - 8)	(1” – No. 4)	(3000)

* The measured cement content shall be within plus or minus 2 mass percent of the design cement content.

** Based on 40 kg/bag

405.4.2 Consistency

Concrete shall have a consistency such that it will be workable in the required position. It shall be of such a consistency that it will flow around reinforcing steel but individual particles of the coarse aggregate when isolated shall show a coating of mortar containing its proportionate amount of sand. The consistency of concrete shall be gauged by the ability of the equipment to properly place it and not by the difficulty in mixing and transporting. The quantity of mixing water shall be determined by the Engineer and shall not be varied without his consent. Concrete as dry as it is practical to place with the equipment specified shall be used.

405.4.3 Batching

Measuring and batching of materials shall be done at a batching plant.

1. Portland Cement

Either sacked or bulk cement may be used. No fraction of a sack of cement shall be used in a batch of concrete unless the cement is weighed. All bulk cement shall be weighed on an approved weighing device. The bulk cement weighing hopper shall be properly sealed and vented to preclude dusting operation. The discharge chute shall not be suspended from the weighing hopper and shall be so arranged that cement will neither be lodged in it nor leak from it.

Accuracy of batching shall be within plus (+) or minus (-) 1 mass percent.

2. Water

Water may be measured either by volume or by weight. The accuracy of measuring the water shall be within a range of error of not more than 1 percent.

3. Aggregates

Stockpiling of aggregates shall be in accordance with Subsection 311.2.10. All aggregates whether produced or handled by hydraulic methods or washed, shall be stockpiled or binned for draining for at least 12 hours prior to batching. Rail shipment requiring more than 12 hours will be accepted as adequate binning only if the car bodies permit free drainage. If the aggregates contain high or non-uniform moisture content, storage or stockpile period in excess of 12 hours may be required by the Engineer.

Batching shall be conducted as to result in a 2 mass percent maximum tolerance for the required materials.

4. Bins and Scales

The batching plant shall include separate bins for bulk cement, fine aggregate and for each size of coarse aggregate, a weighing hopper, and scales capable of determining accurately the mass of each component of the batch.

Scales shall be accurate to one-half (0.5) percent throughout the range used.

5. Batching

When batches are hauled to the mixer, bulk cement shall be transported either in waterproof compartments or between the fine and coarse aggregate. When cement is placed in contact with moist aggregates, batches will be rejected unless mixed within 1-1/2 hours of such contact. Sacked cement may be transported on top of the aggregates.

Batches shall be delivered to the mixer separate and intact. Each batch shall be dumped cleanly into the mixer without loss, and, when more than one batch is carried on the truck, without spilling of material from one batch compartment into another.

6. Admixtures

The Contractor shall follow an approved procedure for adding the specified amount of admixture to each batch and will be responsible for its uniform operation during the progress of the work. He shall provide separate scales for the admixtures which are to be proportioned by weight, and accurate measures for those to be proportioned by volume. Admixtures shall be measured into the mixer with an accuracy of plus or minus three (3) percent.

The use of Calcium Chloride as an admixture will not be permitted.

405.4.4 Mixing and Delivery

Concrete may be mixed at the site of construction, at a central point or by a combination of central point and truck mixing or by a combination of central point mixing and truck agitating. Mixing and delivery of concrete shall be in accordance with the appropriate requirements of AASHTO M 157 except as modified in the following paragraphs of this section, for truck mixing or a combination of central point and truck mixing or truck agitating. Delivery of concrete shall be regulated so that placing is at a continuous rate unless delayed by the placing operations. The intervals between delivery of batches shall not be so great as to allow the concrete in place to harden partially, and in no case shall such an interval exceed 30 minutes.

In exceptional cases and when volumetric measurements are authorized, for small project requiring less than 75 cu.m. per day of pouring, the weight proportions shall be converted to equivalent volumetric proportions. In such cases, suitable allowance shall be made for variations in the moisture condition of the aggregates, including the bulking effect in the fine aggregate. Batching and mixing shall be in accordance with ASTM C 685, Section 6 through 9.

Concrete mixing, by chute is allowed provided that a weighing scales for determining the batch weight will be used.

For batch mixing at the site of construction or at a central point, a batch mixer of an approved type shall be used. Mixer having a rated capacity of less than a one-bag batch shall not be used. The volume of concrete mixed per batch shall not exceed the mixer's nominal capacity as shown on the manufacturer's standard rating plate on the mixer except that an overload up to 10 percent above the mixer's nominal capacity may be permitted, provided concrete test data for strength, segregation, and uniform consistency are satisfactory and provided no spillage of concrete takes place. The batch shall be so charge into the drum that a portion of the water shall enter in advance of the cement and aggregates. The flow of water shall be uniform and all water shall be in the drum by the end of the first 15 seconds of the mixing period. Mixing time shall be measured from the time all materials, except water, are in the drum. Mixing time shall not be less than 60 seconds for mixers having a capacity of 1.5m³ or less. For mixers having a capacity greater than 1.5m³, the mixing time shall not be less than 90 seconds. If timing starts, the instant the skip reaches its maximum raised position, 4 seconds shall be added to the specified mixing time. Mixing time ends when the discharge chute opens.

The mixer shall be operated at the drum speed as shown on the manufacturer's name plate on the mixer. Any concrete mixed less than the specified time shall be discarded and disposed off by the Contractor at his own expenses.

The timing device on stationary mixers shall be equipped with a bell or other suitable warning device adjusted to give a clearly audible signal each time the lock is released. In case

of failure of the timing device, the Contractor will be permitted to continue operations while it is being repaired, provided he furnishes an approved timepiece equipped with minute and second hands. If the timing device is not placed in good working order within 24 hours, further use of the mixer will be prohibited until repairs are made.

Retempering concrete will not be permitted. Admixtures for increasing the workability, for retarding the set, or for accelerating the set or improving the pumping characteristics of the concrete will be permitted only when specifically provided for in the Contract, or authorized in writing by the Engineer.

1. Mixing Concrete: General

Concrete shall be thoroughly mixed in a mixer of an approved size and type that will insure a uniform distribution of the materials throughout the mass.

All concrete shall be mixed in mechanically operated mixers. Mixing plant and equipment for transporting and placing concrete shall be arranged with an ample auxiliary installation to provide a minimum supply of concrete in case of breakdown of machinery or in case the normal supply of concrete is disrupted. The auxiliary supply of concrete shall be sufficient to complete the casting of a section up to a construction joint that will meet the approval of the Engineer.

Equipment having components made of aluminum or magnesium alloys, which would have contact with plastic concrete during mixing, transporting or pumping of Portland Cement concrete, shall not be used.

Concrete mixers shall be equipped with adequate water storage and a device of accurately measuring and automatically controlling the amount of water used.

Materials shall be measured by weighing. The apparatus provided for weighing the aggregates and cement shall be suitably designed and constructed for this purpose. The accuracy of all weighing devices except that for water shall be such that successive quantities can be measured to within one percent of the desired amounts. The water measuring device shall be accurate to plus or minus 0.5 mass percent. All measuring devices shall be subject to the approval of the Engineer. Scales and measuring devices shall be tested at the expense of the Contractor as frequently as the Engineer may deem necessary to insure their accuracy.

Weighing equipment shall be insulated against vibration or movement of other operating equipment in the plant. When the entire plant is running, the scale reading at cut-off shall not vary from the weight designated by the Engineer more than one mass percent for cement, 1-1/2 mass percent for any size of aggregate, or one (1) mass percent for the total aggregate in any batch.

2. Mixing Concrete at Site

Concrete mixers may be of the revolving drum or the revolving blade type and the mixing drum or blades shall be operated uniformly at the mixing speed recommended by the manufacturer. The pick-up and throw-over blades of mixers shall be restored or replaced when any part or section is worn 20mm or more below the original height of the manufacturer's design. Mixers and agitators which have an accumulation of hard concrete or mortar shall not be used.

When bulk cement is used and volume of the batch is 0.5m³ or more, the scale and weigh hopper for Portland Cement shall be separate and distinct from the aggregate hopper or hoppers. The discharge mechanism of the bulk cement weigh hopper shall be interlocked against opening before the full amount of cement is in the hopper. The discharging mechanism shall also be interlocked against opening when the amount of cement in the hopper is underweight by more than one (1) mass percent or overweight by more than 3 mass percent of the amount specified.

When the aggregate contains more water than the quantity necessary to produce a saturated surface dry condition, representative samples shall be taken and the moisture content determined for each kind of aggregate.

The batch shall be so charged into the mixer that some water will enter in advance of cement and aggregate. All water shall be in the drum by the end of the first quarter of the specified mixing time.

Cement shall be batched and charged into the mixer so that it will not result in loss of cement due to the effect of wind, or in accumulation of cement on surface of conveyors or hoppers, or in other conditions which reduce or vary the required quantity of cement in the concrete mixture.

The entire content of a batch mixer shall be removed from the drum before materials for a succeeding batch are placed therein. The materials composing a batch except water shall be deposited simultaneously into the mixer.

All concrete shall be mixed for a period of not less than 1-1/2 minutes after all materials, including water, are in the mixer. During the period of mixing, the mixer shall operate at the speed for which it has been designed.

Mixers shall be operated with an automatic timing device that can be locked by the Engineer. The time device and discharge mechanics shall be so interlocked that during normal operation no part of the batch will be charged until the specified mixing time has elapsed.

The first batch of concrete materials placed in the mixer shall contain a sufficient excess of cement, sand, and water to coat inside of the drum without reducing the required mortar content of the mix. When mixing is to cease for a period of one hour or more, the mixer shall be thoroughly cleaned.

3. Mixing Concrete at Central Plant

Mixing at central plant shall conform to the requirements for mixing at the site.

4. Mixing Concrete in Truck

Truck mixers, unless otherwise authorized by the Engineer, shall be of the revolving drum type, water-tight, and so constructed that the concrete can be mixed to insure a uniform distribution of materials throughout the mass. All solid materials for the concrete shall be accurately measured and charged into the drum at the proportioning plant. Except as subsequently provided, the truck mixer shall be equipped with a device by which the quantity of water added can be readily verified. The mixing water may be added directly to the batch, in which case a tank is not required. Truck mixers may be required to be provided with a means of which the mixing time can be readily verified by the Engineer.

The maximum size of batch in truck mixers shall not exceed the minimum rated capacity of the mixer as stated by the manufacturer and stamped in metal on the mixer. Truck mixing, shall, unless other-wise directed be continued for not less than 100 revolutions after all ingredients, including water, are in the drum. The mixing speed shall not be less than 4 rpm, nor more than 6 rpm.

Mixing shall begin within 30 minutes after the cement has been added either to the water or aggregate, but when cement is charged into a mixer drum containing water or surface wet aggregate and when the temperature is above 32°C, this limit shall be reduced to 15 minutes. The limitation in time between the introduction of the cement to the aggregate and the beginning of the mixing may be waived when, in the judgement of the Engineer, the aggregate is sufficiently free from moisture, so that there will be no harmful effects on the cement.

When a truck mixer is used for transportation, the mixing time specified in Subsection 405.4.4 (3) at a stationary mixer may be reduced to 30 seconds and the mixing completed in a truck mixer. The mixing time in the truck mixer shall be as specified for truck mixing.

5. Transporting Mixed Concrete

Mixed concrete may only be transported to the delivery point in truck agitators or truck mixers operating at the speed designated by the manufacturers of the equipment as agitating speed, or in non-agitating hauling equipment, provided the consistency and workability of the mixed concrete upon discharge at the delivery point is suitable point for adequate placement and consolidation in place.

Truck agitators shall be loaded not to exceed the manufacturer's guaranteed capacity. They shall maintain the mixed concrete in a thoroughly mixed and uniform mass during hauling.

No additional mixing water shall be incorporated into the concrete during hauling or after arrival at the delivery point.

The rate of discharge of mixed concrete from truck mixers or agitators shall be controlled by the speed of rotation of the drum in the discharge direction with the discharge gate fully open.

When a truck mixer or agitator is used for transporting concrete to the delivery point, discharge shall be completed within one hour, or before 250 revolutions of the drum or blades, whichever comes first, after the introduction of the cement to the aggregates. Under conditions contributing to quick stiffening of the concrete or when the temperature of the concrete is 30°C, or above, a time less than one hour will be required.

6. Delivery of Mixed Concrete

The Contractor shall have sufficient plant capacity and transportation apparatus to insure continuous delivery at the rate required. The rate of delivery of concrete during concreting operations shall be such as to provide for the proper handling, placing and finishing of the concrete. The rate shall be such that the interval between batches shall not exceed 20 minutes. The methods of delivering and

handling the concrete shall be such as will facilitate placing of the minimum handling.

405.5 Method of Measurement

The quantity of structural concrete to be paid for will be the final quantity placed and accepted in the completed structure. No deduction will be made for the volume occupied by pipe less than 100mm (4 inches) in diameter or by reinforcing steel, anchors, conduits, weep holes or expansion joint materials.

405.6 Basis of Payment

The accepted quantities, measured as prescribed in Section 405.5, shall be paid for at the contract unit price for each of the Pay Item listed below that is included in the Bill of Quantities.

Payment shall constitute full compensation for furnishing, placing and finishing concrete including all labor, equipment, tools and incidentals necessary to complete the work prescribed in the item.

Payment will be made under:

Pay Item Number	Description	Unit of Measurement
405 (1)	Structural Concrete, Class A	Cubic Meter
405 (2)	Structural Concrete, Class B	Cubic Meter
405 (3)	Structural Concrete, Class C	Cubic Meter
405 (4)	Structural Concrete, Class P	Cubic Meter
405 (5)	Seal Concrete	Cubic Meter

WINDOWS

SCOPE:

The work covered by this section of the specification consists in furnishing all part, labor, materials, fittings, and accessories and in performing all operations in connection with the installation complete, ready for use, of all windows in strict accord with this section of the specifications and the applicable drawings and subject to the terms and conditions of contract.

DOORS

All lumber for the doors including bar doors, cabinet and closet door, and all woodwork of similar nature, shall be kiln`dried with not more than fourteen percent (14) moisture content. All doors shall be done in accordance with full size details which will be furnished hereafter to the contractor. Doors shall have one and three`fourths (44 mm. 0-3/4” finish thickness, unless otherwise specified or shown on drawings and excepting bar doors and gates for counter and railings which shall be one and one-fourth (31mm. (1-1/4”) finished thickness.

Door panels, where so shown on plans shall be raised on both faces set bosc and neither nailed nor glued in place. Rails shall extend through the full width of stiles with mortise and tendon joints, glued wedged and pinned, two pins to each tendon where possible.

All flush doors shall be done in accordance with full size details and of the lumber specified herein. The plywood edged protection shall consist in rabbeting it around into the outside frame of the door in order to prevent "peeling of" of the plywood veneers at the edges.

All doors must be guaranteed against warping, twisting or cracking for a period of six (6) months from the date of final acceptance of the finished building. It is the obligation of the contractor to make good such defects and (or) replace entirely any and all such defective doors. See Schedule of doors on plans.

DOOR KNOBS, LOCK AND LATCH STRIKES:

All lock and latch strikes shall be installed in door frames at the same height from the floor. Door knobs shall be located so that the center of the knob is 0.95 m. from the finished floor; and (or) as directed by the Government Engineer.

BUTT HINGES:

- (a) Each panel of hinged doors shall be hung on (two) butts for door 1.50 m. or less in height; three (3) butts, over 1.50 m. high and not over 2.10 m. in height.

The contractor shall furnish all labor, tools and materials necessary for the complete installation of the plumbing system, including all textures and connections of the building to the sewer main or public sewer, or to and from septic vault as the case may be.

The plumbing shall also include the water service to all fixtures and equipment within the building, the water supply pipes to the nearest water main but not beyond any adjacent public road, street, or avenue. It also includes the waste, soil and vent pipes.

All roughing-in as required for fixtures and equipment, whether installed or not; all work obviously necessary for the proper functioning of all installations, whether or not specifically called for in the specifications or indicated on drawings.

All work shall comply with the plans, Bill of Quantities and with the pertinent provisions of the MWSA regulations, and/ or the National Plumbing Code of the Philippines.

TOILET AND BATHROOM ACCESSORIES

The work covered by this section of the specifications consists in furnishing all plant, labor, equipment and tools, articles, appliances and materials and in performing all operations in connection with the installation of all plumbing fixture, fittings and accessories, complete in strict accord with this section of the specifications and the applicable drawings, and subject to the terms and condition of the contract.

All plumbing fixtures, fittings, accessories, materials and all work obviously necessary for the proper functioning of all installations, whether or not specifically called for in the specifications or indicated on drawings, are included in this work.

ELECTRICAL WORKS

All electrical works herein shall be done in accordance with applicable provisions of the latest edition of the Philippine Electrical Code requirement of the local authorities enforcing the code and requirements of the local company concerned.

All wires shall be copper type THHN in polyvinyl chloride (PVC) conduit unless otherwise specified.

All junction, utility, square and pull boxes shall be GA #16 or approved equivalent and painted with one coat primer prior to installation.

All materials to be used shall be brand new and of the approved type for construction.

Power supply shall be 220v, 1 DIA., 60Hz, 2 wires.

All works herein shall be done under the direct supervision of qualified And duly licensed electrical Engineer or master electrician.

Size of conductors shall be no. 2.0mm² THHN for lighting, no. 3.5mm² THHN for convenience outlet and 8.0mm² THHN for entrance wire

Mounting height from finish floor line to center line of devices are as follows:

- a. Convenience outlet -0.50m
- b. Switches – 1.37m
- c. Panel board/ safety switches -1.90m
- d. Electric meter – 1.67m
- e. Overhead Service Entrance

All vertical and horizontal conduits shall be concealed or embedded on concrete walls and floors.

All conduits shall be properly reamed to installation to avoid damage to the skin of wire.

PLUMBING

The contractor shall furnish all labor, tools and materials necessary for the complete installation of the plumbing system, including all textures and connections of the building to the sewer main or public sewer, or to and from septic vault as the case may be.

The plumbing shall also include the water service to all fixtures and equipment within the building, the water supply pipes to the nearest water main but not beyond any adjacent public road, street, or avenue. It also includes the waste, soil and vent pipes.

All roughing- in as required for fixtures and equipment, whether installed or not; all work obviously necessary for the proper functioning of all installations, whether or not specifically called for in the specifications or indicated on drawings.

All work shall comply with the plans, Bill of Quantities and with the pertinent provisions of the MWSA regulations, and/ or the National Plumbing Code of the Philippines.

TOILET AND BATHROOM ACCESSORIES

The work covered by this section of the specifications consists in furnishing all plant, labor, equipment and tools, articles, appliances and materials and in performing all operations in connection with the installation of all plumbing fixture, fittings and accessories, complete in strict accord with this section of the specifications and the applicable drawings, and subject to the terms and condition of the contract.

All plumbing fixtures, fittings, accessories, materials and all work obviously necessary for the proper functioning of all installations, whether or not specifically called for in the specifications or indicated on drawings, are included in this work.

ITEM 409 – WELDED STRUCTURAL STEEL

409.1 Description

This work shall consist of the joining of structural steel members with welds of the type, dimensions, and design shown on the Plans and in accordance with the Specifications.

It is the intent of this Specification to provide for work of a quality comparable to that required under the Standard Specifications for Welded Highway and Railway Bridges of the American Welding Society. In case of dispute or for situations not adequately provided for in this Specification, those designated Standard

Specifications shall be considered as the final authority and shall govern except as amended by the Special Provisions.

Welding of Structural Steel shall be done only when shown on the Plans or authorized in writing by the Engineer.

409.2 Materials Requirements

Steel base metal to be welded shall be open-hearth or electric furnace steel conforming to AASHTO M 183.

All arc-welding electrodes shall conform to the requirements of American Welding Society Specifications. Electrodes shall be of classification numbers E7016, E7018 or E7028 as required for the positions, type of current and polarity, and other conditions of intended use, and to conform to any special requirements indicated on the Plans.

Filler material to be used in the repair or strengthening of old structures or for joining new parts to existing steel members, shall be adopted to the material to be welded and may depart from the foregoing requirements only if agreed by the Engineer.

409.3 Construction Requirements

409.3.1 Equipment

409.3.1.1 General

All items of equipment for welding and gas cutting shall be so designed and manufactured and in such condition as to enable qualified welders to follow the procedures and attain the results prescribed in this Specification.

409.3.1.2 Arc-Welding Equipment

Welding generators and transformers shall be designed expressly for welding. They shall be capable of delivering steady currents adjustable through a range ample for the work requirements. They shall respond automatically and quickly to changes in power requirements due to variations in arc length and shall deliver full current promptly on striking an arc.

Welding cable shall have sufficient conductivity to avoid overheating and inadequate current at the arc and shall be effectively insulated against welding circuit voltage. Earth or ground connections and circuits shall be secured and adequate to carry the welding currents.

Electrode holders shall grip the electrode firmly and with good electrical contact.

Approved automatic welding heads may be used, with suitable auxiliary handling equipment to provide automatic instead of manual control of electrode and welding arc.

409.3.1.3 Gas-Cutting Equipment

Torches and tips shall be of proper size and type of the work at hand. Suitable regulators shall afford the welder complete control over the pressure and rate of flow of each gas.

409.3.1.4 Protective Equipment

All personnel protective equipment shall conform to the American Standard Association Code for such equipment.

The Contractor shall enforce the use of approved accessories necessary for the protection and convenience of the welders and for the proper and efficient execution of the work.

Suitable protection against the light of the arc shall be maintained by the Contractor when arc-welding operation might be viewed within harmful range by persons other than the actual welders and inspectors.

409.3.2 Welding

409.3.2.1 General

Welding shall be performed by the metal-arc process, using the electrodes specified with either direct or alternating current.

Surfaces to be welded shall be smooth, uniform and free from fins, tears, and other defects which would adversely affect the quality of the weld. Edges of material shall be trimmed by machining, chipping, grinding, or machine gas-cutting to produce a satisfactory welding edge wherever such edge is thicker than: 13 mm for sheared edge of material; 16 mm for toes of angles or rolled shapes (other than wide flange sections); 25 mm for universal mill plate or edges of flange sections.

The width of root face used, shall be not more than 1.5 mm for parts less than 10 mm in thickness nor more than 3 mm for parts 10 mm or more in thickness.

Butt welds shall be proportioned so that their surface contours will lie in gradual transition curves. For butt welded joints between base metal parts of unequal thickness, a transition shall be provided on a slope or level not greater than 1 in 2.5 to join the offset surfaces. This transition may be provided by sloping the surface of the weld metal or by bevelling the thicker part or by combination of these two methods.

Surfaces to be welded shall be free from loose scale, slag, rust, grease or other material that will prevent proper welding. Mill scale that withstands vigorous wire brushing or a light film of drying oil or rust inhibitive coating may remain. Surfaces within 50 mm of any weld location shall be free of any paint or other material that would prevent proper welding or produce objectionable fumes while welding.

No operation or actual welding or gas-cutting shall be performed on a member while it is carrying live load stress or while subject to shock and vibration and from moving loads. Welding and gas-cutting shall cease in advance of the application of such loads.

409.3.2.2 Welders

All welding shall be done by approved competent and experienced and fully qualified welders.

409.3.2.3 Preparation of Materials for Welding

Dimensional tolerance, straightness and flatness of the structural shapes and plates shall be within the limits prescribed in this Specification.

Structural steel which is to be welded shall preferably not be painted until all welding is completed.

Preparation of edges by gas-cutting shall, wherever practicable, be done by machine gas-cutting. Machine gas-cutting edges shall be substantially as smooth and regular as those produced by edge planning and shall be left free of slag. Manual gas cutting shall be permitted only where machine gas-cutting is not practicable and with the approval of the Engineer. The edge resulting from manual gas-cutting shall be inspected and smoothed with special care. All

re-entrant corners shall be filleted to a radius at least 19 mm. The cut lines shall not extend beyond the fillet and all cutting shall follow closely the line prescribed.

409.3.2.4 Assembly

The parts to be joined by fillet welds shall be brought into a close contact as practicable, and no event shall be separated more than 5 mm. If the separation is 1.5 mm or greater, the leg of the fillet weld shall be increased by the amount of separation. The separation between faying surfaces of lap joints and of butt joints landing on a backing structure shall not exceed 1.5 mm. The fit of joints which are not sealed by welds throughout their length shall be sufficiently close to exclude water after painting. Where irregularities in rolled shape or plates, after straightening, do not permit contact within the above limits, the procedure necessary to bring the material within these limits shall be subject to the approval of the Engineer.

Cutting parts to be joined by butt welds shall be carefully aligned. Where the parts are effectively restrained against bending due to eccentricity or alignment, a maximum offset of 10 percent of the thickness or the thinner part joined, but in no case more than 3 mm, may be permitted as a departure from the theoretical alignment. In connecting alignment in such cases, the parts shall not be drawn into a greater slope than two degrees (1 in 30). Measurement of offset shall be between centerline of parts unless otherwise shown on the Plans.

When parts abutting edge to edge differ in thickness, the joint shall be of such form that the slope of either surface through the transition zone does not exceed 1 in 2.5, the thicker part being bevelled, if necessary.

Members to be welded shall be brought into correct alignment and held in position by bolts, clamps, wedges, guy lines, struts, other suitable devices or tack welds until welding has been completed. The use of jigs and fixtures is recommended where practicable. Such fastening devices as may be used shall be adequate to insure safety.

Plug and slot welds may be used to transmit shear in a lap joint or to prevent the buckling or separation of lapped parts.

The diameter of the hole for a plug weld shall not be less than the thickness of the part containing it plus 8 mm nor shall it be greater than 2.25 times the thickness of the weld.

The minimum center spacing of plug welds shall be four times the diameter of the hole.

The length of the slot for a slot weld not exceed ten times the thickness of the weld. The width of the slot shall not be less than the thickness of the part containing it plus 8 mm nor shall it be greater than 2.25 times the thickness of the weld.

The ends of the slot shall be semicircular or shall have the corners rounded to a radius not less than the thickness of the part containing it, except those ends which extend to the edge of the part.

The minimum spacing of lines of slot welds in a direction transverse to their length shall be 4 times the width of the slot.

The minimum center to center spacing in a longitudinal direction on any line shall be 2 times the length of the slot.

The thickness of plug or slot welds in material 16 mm or less in thickness shall be equal to the thickness of the material.

In material over 16 mm in thickness, it shall be at least one-half the thickness of the material but not less than 16 mm.

Tack welds, located where the final welds will later be made, shall be subject to the same quality requirements as the final weld. Tack welds shall be as small as practicable and where encountered in the final welding, shall be cleaned and fused thoroughly with the final weld. Defective, cracked or broken tack welds shall be removed before final welding.

Members or component parts of structures shall be assembled and matchmarked prior to erection to insure accurate assembly and adjustment of position on final erection. Painted assembly marks shall be removed from any surface to be welded.

409.3.2.5 Control of Distortion and Shrinkage Stresses

In assembling and joining parts of a structure or a built-up member and in welding reinforcing parts to existing members, the procedure and sequence of welding shall be such as will avoid distortion and minimize shrinkage stresses.

As far as practicable, long parallel lines of welding on a part or member shall be executed concurrently, and all welds shall be deposited in a sequence that will balance the applied heat of welding on various sides as much as possible while the welding progresses.

Before the commencement of welding on a structural member in which severe shrinkage stresses or distortion are likely to occur, a complete program for welding sequence and distortion control shall be submitted to the Engineer and shall be subject to his approval.

The direction of the general progression in welding on a member shall be from points where parts are relatively fixed in position, with respect to each other, toward points which have a greater relative freedom of movement.

Where part or member is to be welded on both ends into a rigid structure or assembly, the connection at which the greatest shrinkage will occur in the direction of the length of the part or member, shall be made while the part or member is free to move in the direction of the shrinkage; and the connection involving the least shrinkage shall be made last.

A weld designed to sustain tensile stress shall be made in such a way that their welding is being performed at any point, all parts that would offer restraint against shrinkage can shrink, deform or move enough to preclude serious shrinkage stresses.

In welding of built-up members of heavy sections, particularly those T or H-shapes where the flanges are considerably heavier than the stems or webs, and in any case where the component parts are 38 mm or greater in thickness, special care shall be exercised during welding to avoid weld cracking. In the welding of members of such heavy section, the temperature of contiguous areas about a welding operation shall be equal, and not less than 55°C. If necessary, the lighter parts shall be heated while the weld is cooling, to keep the temperature of contiguous parts substantially equal.

In the fabrication of cover-plated beams and built-up members, all shop splices in each component part shall be made before such component part is welded to other parts of the member.

In making all butt-welded splices in rolled shapes and in making butt-welded field splices in built-up sections (such as in H or I-sections) the sequence and procedure of welding shall be such as to take into account unequal amounts of expansion or contraction in the parts being welded. The procedure and sequence shall be such that while the weld and the heated base metal are contracting at any point, any part of the member that would furnish restraint against such contraction can move or shrink enough to prevent the shrinkage of the heated metal from producing harmful internal stresses. The procedure and sequence that is used for

making such splices shall be planned in advance in full detail and submitted to the Engineer and shall be subject to his approval.

The ends of all butt welds in flanges of beams and girders shall be made with extension bars regardless of the thickness of such flanges.

Welding shall not be done when surfaces are wet from condensation or rain which is falling on the surfaces to be welded; nor during periods of high winds unless the welding operator and the work are properly protected.

409.3.2.6 Technique of Arch-Welding

The welding current shall conform with respect to voltage and current (and polarity, of direct current is used) to the recommendations of the manufacturer of the electrode being used, as indicated in the instructions that are included with each container of electrodes.

Arc lengths and electrical potential and current shall be suited to the thickness of material, type of groove and other circumstances attendant to the work.

The maximum size of electrode permitted shall be 5 mm with the following exceptions:

1. The maximum size for flat position welding of all passes except the root pass shall be 8 mm.
2. The maximum size for horizontal fillet welds shall be 6 mm.

The electrode for the single pass fillet weld and for the root passes of all multiple layer welds in all cases shall be of the proper size to insure thorough fusion and penetration with freedom from slag inclusions.

A single layer of the weld metal, whether deposited in one pass or made up of several parallel beads, shall not exceed 3 mm in thickness except that the bead at the root may be 6 mm in thickness if the position of welding and the viscosity of the weld metal permit control of the latter so that it does not over flow upon unfused base metal.

The maximum size of fillet weld which may be made in one pass shall be 8 mm except that for vertical welds made upward the maximum size made in one pass shall be 13 mm.

In vertical welding the first root pass shall be formed from the bottom upward. Succeeding passes may be formed by any technique that will fulfill the requirements of the Specification and Plans.

The electrode manipulation during welding shall insure that:

1. Complete fusion between the base metal and the deposited weld metal is obtained.
2. The melted base metal is replaced by weld metal so that no undercut remains along the edges of the finished weld.
3. The molten weld metal floats all slag, oxide and gases to the surface behind the advancing arc.

Each time the arc is started, either to begin a weld or to continue partly completed weld, the arch shall be manipulated to obtain complete fusion of the deposited weld metal with the base metal and with any previously deposited weld metal, before any progression of the arc along the joint.

At the completion of a pass or weld, the arc shall be manipulated so as to fill the crater with sound metal.

Before welding over previously deposited metal, the slag shall be removed and the weld and adjacent base metal shall be brushed clean. This requirement shall apply not only to cratered areas but also when welding is resumed after any interruption. It shall not, however, restrict the making of plug and slot welds, in accordance with the following paragraphs.

In making plug welds the following techniques shall be used:

1. For flat welds, the arc shall be carried around the root of the joint and then weaved along a spiral path to the center of the hole, fusing and depositing a layer of weld metal in the root and bottom of the joint. The arc shall then be carried to the periphery of the hole, and the procedure repeated, fusing and depositing successive layers to fill the hole to the depth required. The slag covering the weld metal shall be kept molten, or nearly so, until the

weld is finished. If the arc is broken, except briefly for changing electrodes, the slag must be allowed to cool and shall be completely removed before restarting the weld.

2. For vertical welds, the arc shall be started at the root of the joint, at the lower side of the hole and carried upward on the zigzag path, depositing a layer about 5 mm thick on the exposed face at the thinner plate and fused to it and to the side of the hole. After cleaning the slag from the weld, other layers shall be similarly deposited to fill the hole to the required depth.
3. For overhead welds, the procedure shall be the same as for flat welds except that the slag shall be allowed to cool and shall be completely removed after depositing each successive layer until the hole is filled to the required depth.

Slot welds shall be made with a technique similar to that specified above for plug welds, except that if the length of the slot exceeds three times the width, or if the slot extends to the edges of the part of the technique specified above for making plug welds shall be followed for the type of flat position welds.

409.3.2.7 Details of Welds

The following tabulation shows that the relation between weld size and the maximum thickness of material on which various sizes of fillet welds may be used:

Size of Fillet Weld	Maximum Thickness of Part
5 mm	13 mm
6 mm	19 mm
8 mm	32 mm
10 mm	51 mm
13 mm	152 mm
16 mm over	152 mm

The maximum size of fillet weld that may be used along the edge of material 6 mm or

more in thickness shall be 1.5 mm less than the thickness of the material.

The minimum effective length of fillet weld shall be four times its size and in no case less than 38 mm.

Fillet welds terminating at the corners of parts or members shall, wherever practicable, be turned continuously full size around the corners for a distance not less than twice the nominal size of the weld.

Intermittent fillet welds, preferably, shall not be used. They shall be permitted only where the required weld area is less than that of a continuous fillet weld of the minimum size. If used on main members, they shall be chain intermittent welds. In all other cases, chain intermittent welding is preferable to staggered intermittent welding.

Spacing of intermittent fillet welds shall be measured between the center of the weld segments. The spacing shall conform to the following requirements unless calculated stresses between the parts require closer spacing:

1. At the end of members, there shall preferably be continuous longitudinal fillet welds at least as long as the width of the element or member being connected.
2. The clear spacing in the direction of stress of stitch welds that connect plates to other plates or to shapes shall not exceed:
 - a. For compression members10 times the thickness of the thinner part but not more than 300 mm.
 - b. For tension members 14 times the thickness of the thinner part but not more than 300 mm.

The spacing transverse to the direction of stress shall not exceed 24 times the thickness of the thinner part connected.

3. For members composed of two or more rolled shapes in contact with one another, the longitudinal spacing of stitch welds shall not exceed 600 mm.

Fillet welds in holes or slots may be used to transmit shear in lap joints or to prevent the buckling or separation of lapped parts. The fillet welds in a hole or slot may overlap.

Seal welding shall preferably be accomplished by a continuous weld combining the function of sealing and strength, changing sections only as the required strength may necessitate.

Exposed faces of welds shall be made reasonably smooth and regular, shall conform as closely as practicable to the design requirements and shall not at any place be inside the intended cross-section. Weld dimension in excess of the design requirements shall not be a cause for rejection, but in case excess weld metal involves serious malformation, such work shall be rejected.

All fillet welds shall be of acceptable types. All fillet welds that carry reversed stresses running in a direction perpendicular to their longitudinal axis shall be of the concave type or the 0-gee type when the fillet weld is flushed with the edge of a member. When one of these types is specifically indicated on the Plans for a weld, it shall be of that type.

Butt welds shall preferably be made with a slight reinforcement, except as may be otherwise provided, and shall have no defects. The height of reinforcement shall be not more

than 3 mm.

All butt welds, except produced with aid of backing material, shall have the root of the initial layer chipped out or otherwise cleaned to sound metal and welded in accordance with the requirements of the Specification. Butt welds made with the use of a backing of the same materials as the base metal shall have the weld metal thoroughly fused with the backing materials.

Ends of butt welds shall be extended past the edges of the parts joined by means of extension bars providing a similar joint preparation and having a width not less than the thickness of the thicker part jointed; or for material 19 mm or less in thickness, the ends of the welds shall be chipped or cut down to solid metal and side welds applied to fill out the ends to the same reinforcement as the face of the welds. Extension bars shall be removed upon completion and cooling of the weld and the ends of the weld made smooth and flush with the edges of the abutting parts.

409.3.2.8 Quality of Welds

Weld metal shall be solid throughout except that very small gas pockets and small inclusions of oxide or slag may be accepted if well dispersed and if none exceeds 1.5 mm in greatest dimension, and if the sum of the greatest dimensions of all such defects of weld metal area does not exceed 15 mm in an area of 10 cm².

There shall be complete fusion between the weld metal and the base metal and between successive passes throughout the joint.

Welds shall be free from overlap and the base metal free from undercutting. All craters shall be filled to the full cross- section of the welds.

409.3.2.9 Correction

In lieu of rejection of an entire piece of member containing welding which is unsatisfactory or indicates inferior workmanship, the following corrective measures may be permitted by the Engineer whose specific approval shall be obtained for making each correction:

1. Removal of part or all of the welds shall be affected by chipping, grinding or gas-gouging.
2. Defective or unsound welds shall be corrected either by removing and replacing the welds, or as follows:
 - a. Excessive convexity – Reduce to size by removal of excess weld metal.
 - b. Shrinkage crack in base metal, craters and excessive porosity – Remove defective portion of base and weld metal down to sound metal and deposit additional weld metal.
 - c. Undercutting, undersize and excessive concavity – Clean and deposit additional weld metal.
 - d. Overlapping and lack of fusion – Remove and replace the defective length of weld.
 - e. Slag inclusion – Remove those parts of the weld containing slag and fill with weld metal.
 - f. Removal of adjacent base metal during welding – Clean and form full size by depositing additional weld metal.
3. Where corrections require the depositing of additional weld metal, the electrode

used shall be smaller than the electrode used in making the original weld.

4. A cracked weld shall be removed throughout its length, unless by the use of acid etching, magnetic inspection or other equally positive means, the extent of the crack can be ascertained to be limited, in which case sound metal 50 mm or more beyond each end of the crack need not be removed.
5. In removing defective parts of a weld, the gas-gouging, chipping or grinding shall not extend into the base metal any substantial amount beyond the depth of the web penetration unless cracks or other defects exist in the base metal.
6. Where the work performed subsequent to the making of a deficient weld has rendered the weld inaccessible or has caused new conditions which would make the correction of the deficiency dangerous or ineffectual, the original condition shall be restored by renewal of welds or members, or both before making the necessary corrections, or else the deficiency shall be compensated by additional work according to a revised design approved by the Engineer.
7. Caulking of welds shall not be done.

8. Before adding weld metal or rewelding, the surfaces shall be cleaned thoroughly. Where incomplete fusion is disclosed by chipping, grinding or gas gouging, to correct defects, that part of the weld shall be removed and rewelded.

409.3.2.10 Stress Relieving

Peening to reduce residual stress of multi-layer welds may be used only if authorized and ordered by the Engineer. Care shall be exercised to prevent overpeening which may cause overlapping, scaling, flecking or excessive cold working of weld and base metal.

409.3.2.11 Cleaning and Protective Coatings

Painting shall not be done until the work has been accepted and shall be in accordance with the Specification. The surface to be painted shall be cleaned of spatter, rust, loose scale, oil and dirt. Slag shall be cleaned from all welds.

Welds that are to be galvanized shall be treated to remove every particle of slag.

409.3.2.12 Identification

The operator shall place his identification mark with crayon, or paint, near the welds made by him.

409.3.2.13 Inspection

On completion of the welding work, inspection shall be carried out by an Inspector appointed by the Engineer.

The size and contour of welds shall be measured with suitable gauges. The inspector shall identify with a distinguishing mark all welds that he has inspected and accepted.

The Contractor shall remove and replace, or correct as instructed, all welds found defective or deficient. He shall also replace all methods found to produce inferior results, with

methods which will produce satisfactory work.

In the event that fault welding or the removal for rewelding of faulty welding shall damage the base metal, the Contractor shall remove and replace the damaged material.

409.4 Measurement and Payment

Unless otherwise provided in the Special Provisions, welded structural steel structures shall not be measured and paid for separately, but the cost thereof shall be considered as included in the contract price for other items.

PAINTING

SCOPE OF WORK:

- (a) The work covered by this section of the specification consists in the proper preparation of surfaces, the furnishing of all plant, labor, materials, tools, appliances, scaffolding and other necessary equipment and in performing all operations in connection with painting and varnishing work, complete in accordance with color scheme and as specified herein and subject to the terms and conditions of the contract.
- (b) This section of the specifications covers the complete painting and finishing of all wood surfaces, the painting of plasters, brick, concrete, stucco, unfinished metal and other surfaces throughout the interior and exterior of the building, and (or) other surfaces indicated on the color scheme and schedule, except where otherwise specified
- (c) Surface to be varnished:
Unless otherwise specified in the color scheme approved by the PMO, or otherwise specified hereinafter, all wooden doors, transom sashes, transom frames, door trimmings or casing, window sill, wood handrails of stairs, wooden counters, counter cabinets and open shelving; also other wood surfaces and surfaces of other materials indicated as varnish finish (polished or satin) in the color scheme and (or) directed by the Engineer.
- (d) All paint materials shall meet the requirements of the specifications by the Standardizations Committee on Supplies and shall be delivered on the job in the original container, with labels intact and scales unbroken.
- (e) The use of ready mixed paint may be allowed in this project provided that all paint materials shall conform to the Standard Specifications No. 13 of the Philippine Government and that ready mixed paints shall be those listed under "Good Substitutes" only and (or) classified as "Good Quality" as certified by the Institute of Science and Technology.
- (f) The workmanship shall be the very best. All materials shall be applied under adequate illumination, evenly spread and smoothly flowed on without runs or sags.

- (g) Color scheme for the painting and varnishing of the whole building, complete, both inside and outside shall be furnished later to the contractor upon request. Color scheme and varnished samples required by this specifications and (or) by the PMO shall be submitted by the Contractor for approval at his own expense.
- (h) Paint shall be thoroughly stirred so as to keep the pigment evenly in suspension while paint is being supplied to rollers.
- (i) All painting and varnishing work shall be done in workmanship manner by skilled house painters and varnishers only.
- (j) In general and unless otherwise specified, and (or) instructed by the Engineer due to actual conditions on the job, not less than 48 hours' time shall elapse between application of succeeding coats.
- (k) Except where otherwise noted by specified, all paints shall be applied in three (3) coats (priming, body and finish).
- (l) The use of roller for paint application is required, except on inaccessible surfaces in which case the painter's brush (nylon brush) shall be used.
- (m) Surfaces which cannot be satisfactorily finished in the number of coats specified shall have such additional coats, or such preparatory coats and subsequent coats as may be required to produce satisfactory finished work.
- (n) Tinting colors for oil paint shall be colored-in-roll, ground in pure linsed oil, and of the highest grade obtainable.
- (o) Colors shall be non-fading.
- (p) Color pigments shall be sued to produce the exact shades of paint which shall conform to the approved color scheme of the building.

Except as otherwise noted, color of priming cost shall be lighter than the finish coat. The first coat shall be white.

Section VII. Drawings

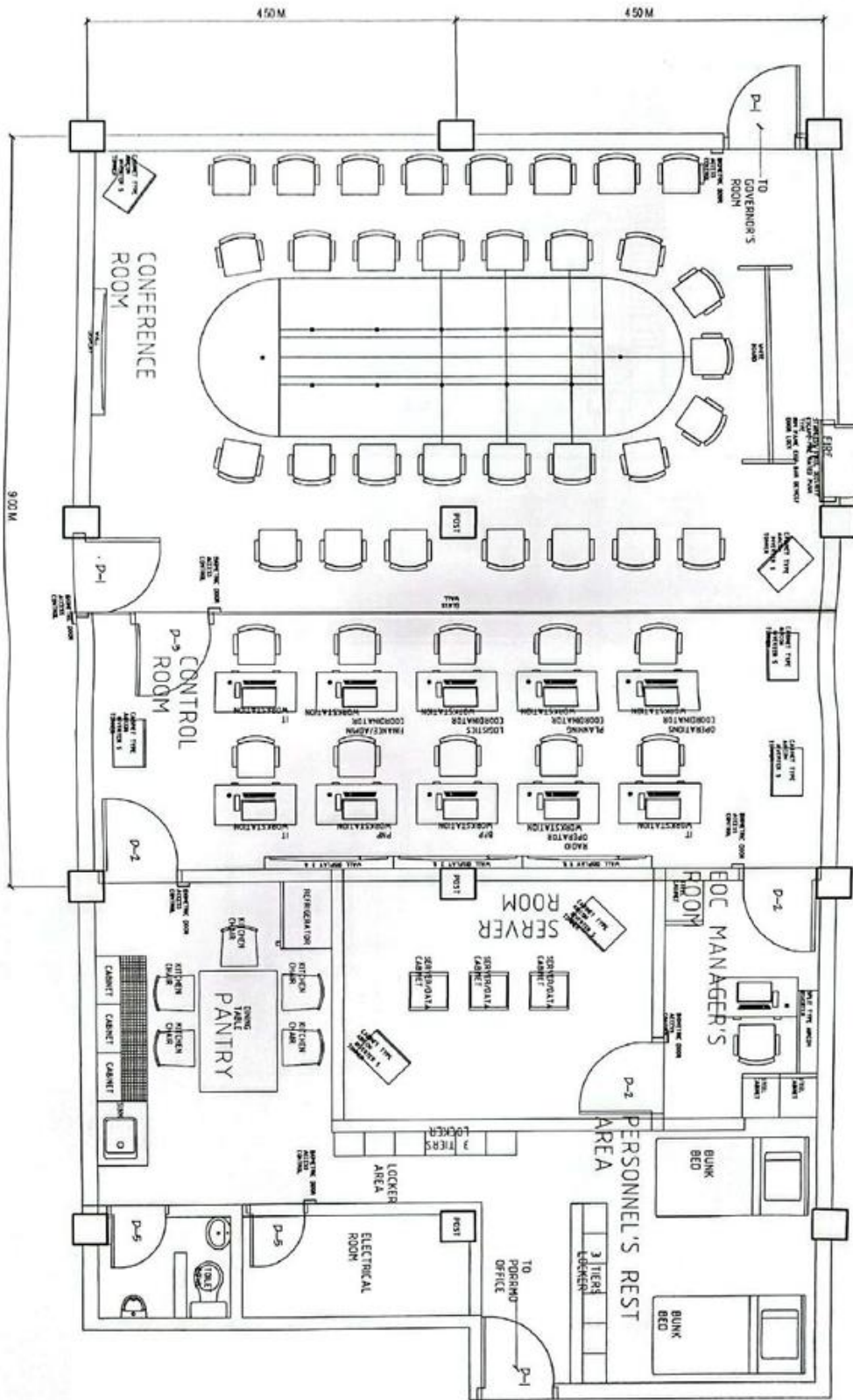

FLOOR PLAN

SCALE 1:600 METERS

PROJECT TITLE/LOCATION: ESTABLISHMENT OF PROVINCIAL EMERGENCY OPERATIONS CENTER(EOC) PHASE-1 PROVINCIAL CAPITAL BUILDING DIST. CAMARINES NORTE	PREPARED BY: NAPOLION & PARRIDO DRAFTSMAN	CHECKED & SUBMITTED BY: SANTOS CHIEF PLANNING DIVISION	REVIEWED & VERIFIED BY: FLORENZALTA ASST. PROVINCIAL ENGINEER	RECOMMENDING APPROVAL: JOHNVANIL S. TOBIAS PROVINCIAL ENGINEER	APPROVED BY: ROBERTO R. PADILLA GOVERNOR	SMT. CANDIDO SMT. NOLAN
--	---	--	---	--	--	-------------------------

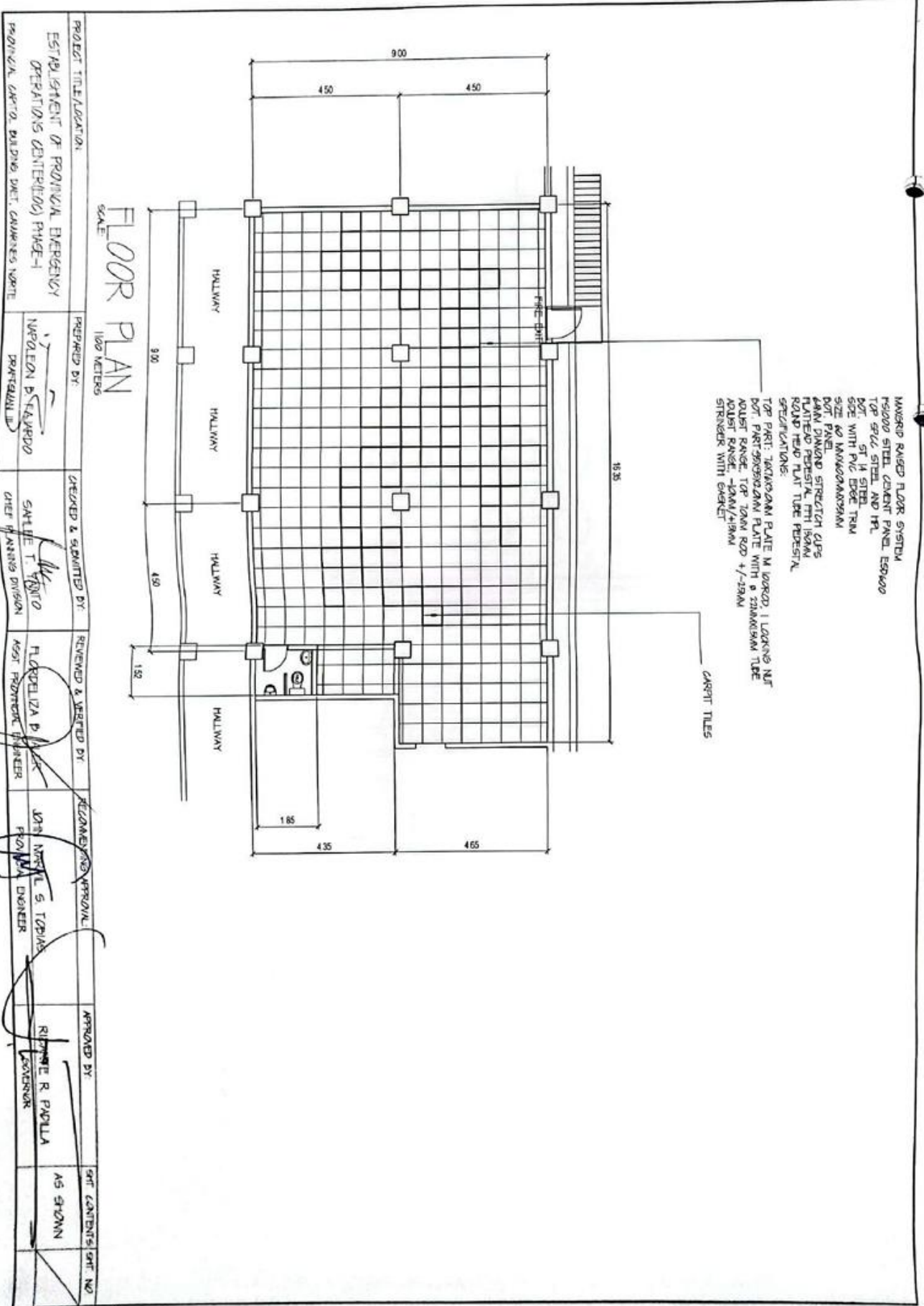

FLOOR PLAN
SCALE 1:100 METERS

MASSIP RAISED FLOOR SYSTEM
 750000 STEEL CONCRETE PANEL ESB/600
 TOP 90% STEEL AND 10%
 10% ST 1/4 STEEL
 10% WITH PVC EDGE TRIM
 SIZE 60 MARGO/MARGO/M
 MAIN DIMENSION STRUTS
 PLATE AND PEDISTAL WITH ISOM
 ROUND HEAD FLAT TUBE PEDISTAL
 SPECIFICATIONS:
 TOP PART: 1000MM PLATE M 100000 1 LOCKING NUT
 DOT PART: 1000MM PLATE WITH 8 20MM ISOM TUBE
 ADJUST RANGE: TOP 10MM R20 +/- 25MM
 ADJUST RANGE: 10MM/15MM
 STRONGER WITH GARNET
 CARPET TILES

PROJECT TITLE/LOCATION: ESTABLISHMENT OF PRONIVA EMERGENCY OPERATIONS CENTER (EOP) PHASE-1 PRONIVA CANTO BUILDING SWIT. CONVENES NORTH	PREPARED BY: NARCISON B. SARDUO DRAWING	CHECKED & SUBMITTED BY: SANTO T. YRIBO CHIEF PLANNING DIVISION	REVIEWED & VERIFIED BY: FLORDELIZA B. ALK ASST. PROJECT ENGINEER	REGISTERED APPROVAL: JOHN M. S. TOPINA PROJ. ENGINEER	APPROVED BY: RICHARDE R. POCILLA SUPERVISOR	SHR. CONTENTS SHR. NO.
--	---	--	--	---	---	------------------------

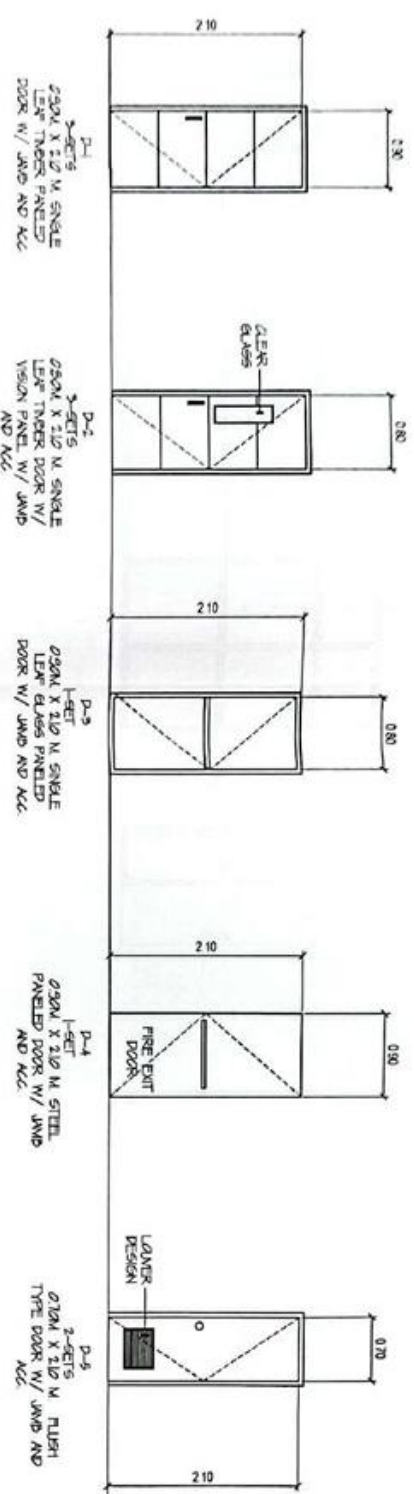

SCHEDULE OF DOORS AND WINDOWS

SCALE: 1:50 METERS

PROJECT TITLE/LOCATION ESTABLISHMENT OF PROVINCIAL EMERGENCY OPERATIONS CENTER(EDC) PHASE-I PROVINCIAL CAPITAL BUILDING DIST. CAMARINES NORTE	PREPARED BY: NAPOLEON B. TANREDO DRAFTSMAN III	CHECKED & SUBMITTED BY: SATURNINO T. VANTIO CHIEF PLANNING DIVISION	REVIEWED & APPROVED BY: FLORELIZA B. LOPEZ ASST. PROVINCIAL ENGINEER	RECOMMENDED APPROVAL: JOHN MARVIL S. TOBIAS PROVINCIAL ENGINEER	APPROVED BY: EDGARDO R. PADILLA GOVERNOR	SHEET CONTENTS SHEET NO.
--	--	---	--	---	--	--------------------------

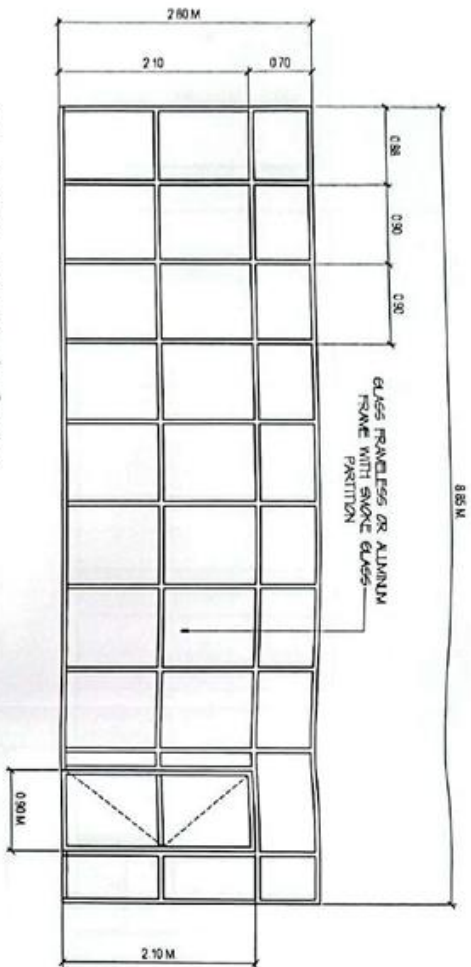

GLASS PARTITION
SCALE: 1/50 METERS

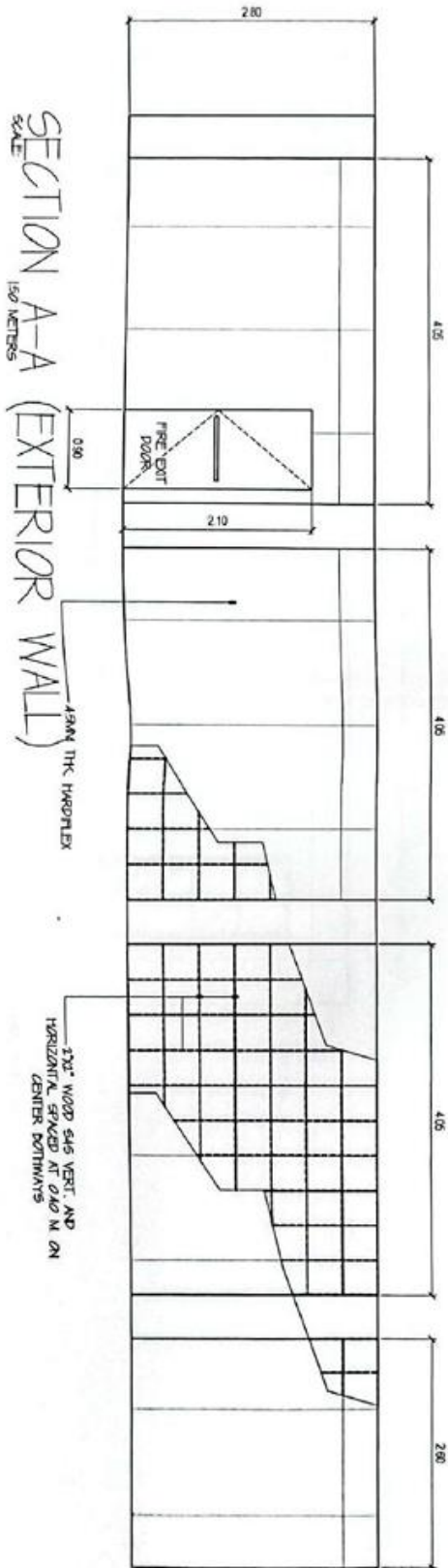

SECTION A-A (EXTERIOR WALL)
SCALE: 1/50 METERS

PROJECT TITLE/LOCATION: ESTABLISHMENT OF PROVINCIA EMERGENCY OPERATIONS CENTER(EOC) PHASE-I PROVINCIA CAPITAL BUILDING DIST. CAMARINES NORTE	PREPARED BY: NAPOLION B. CALUAG DRAFTSMAN II	CHECKED & SUBMITTED BY: SANTOS T. TORIO CHIEF PLANNING DIVISION	REVIEWED & VERIFIED BY: FLORDELIZAL FIER ASST. PROVINCIAL ENGINEER	RECOMMENDING APPROVAL: JOHN TORRES S. TORRES PROVINCIAL ENGINEER	APPROVED BY: RICHARD R. PADILLA ENGINEER	SIT. CONTENTS/SIT. NO.
--	--	---	--	--	--	------------------------

SECTION C-C (EXTERIOR WALL)
SCALE 1:50 METERS

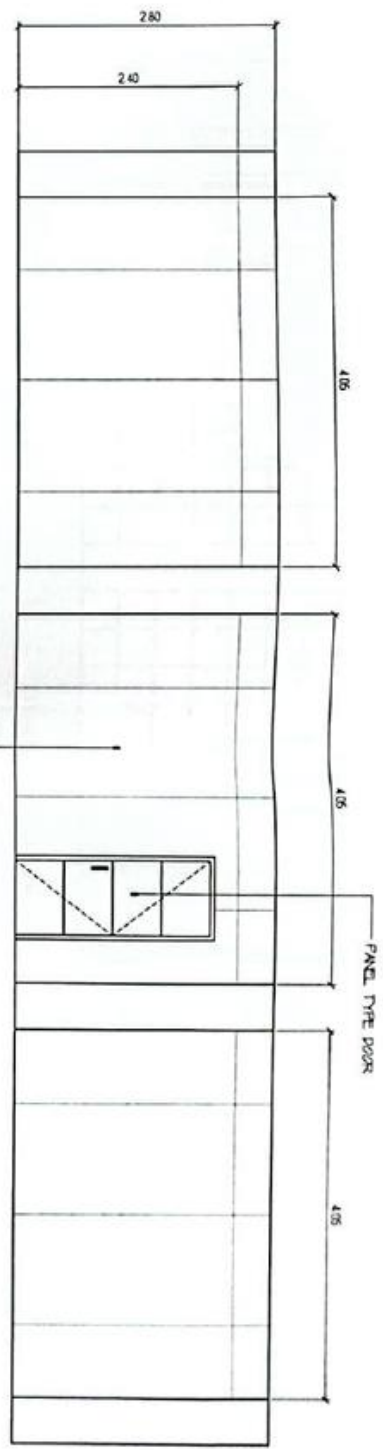

SECTION B-B
SCALE 1:50 METERS

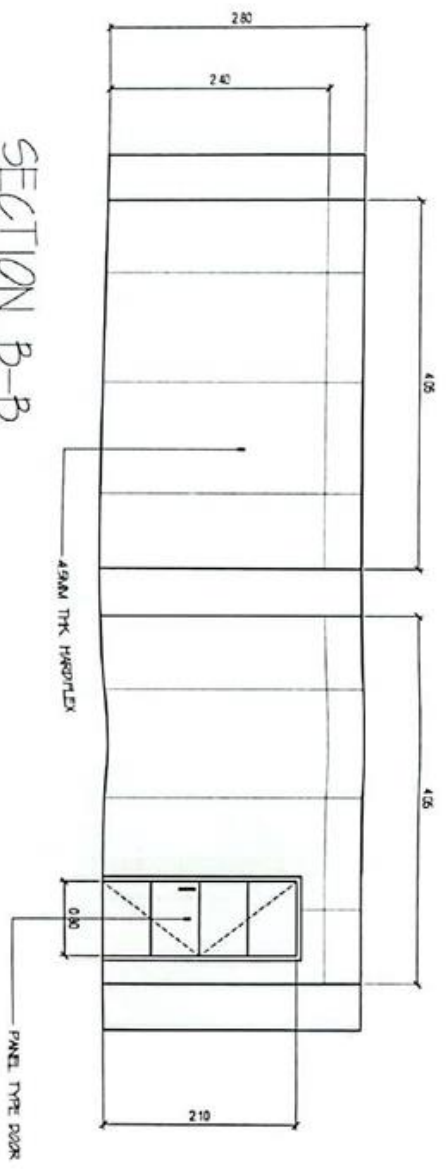

PROJECT TITLE/LOCATION ESTABLISHMENT OF PROVINCIAL EMERGENCY OPERATIONS CENTRE(S) PHASE-1 PROVINCIAL CAPITAL BUILDING, DIST. CAMERONS NORTH	PREPARED BY NAPOLEON B. SALGADO DRAWINGMAN III	CREATED & SUBMITTED BY SANTHE T. YARDO CHIEF PLANNING DIVISION	REVIEWED & VERIFIED BY FLORDELIZA B. DE LA ROSA ASST. PROVINCIAL ENGINEER	RECOMMENDING PERSON JOHN MARVIN S. TOPALAN PROVINCIAL ENGINEER	APPROVED BY RUBEN T. R. PANTILA GOVERNOR	SHEET CONTINUED SHEET NO. AS SHOWN
---	--	--	---	--	--	---------------------------------------

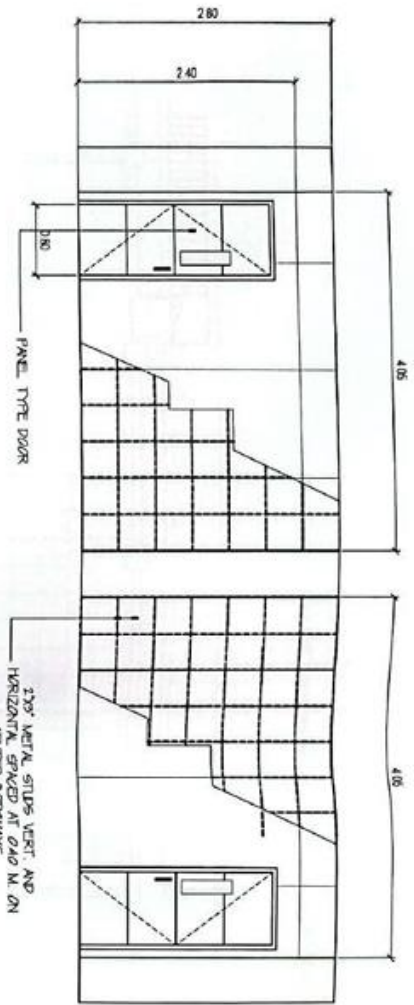

SECTION D-D
SCALE 1:50 METERS

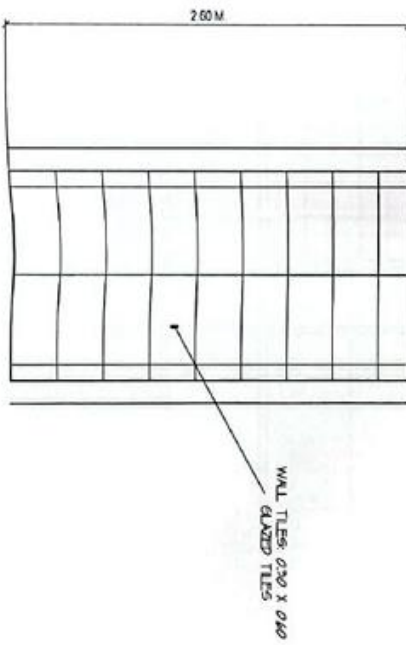
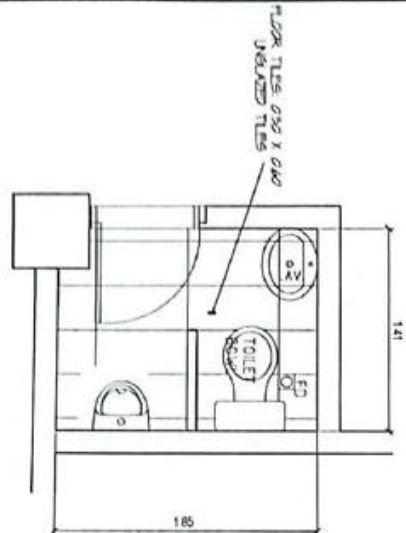

PLAN OF CONFORT ROOM
SCALE 1:50 METERS

PROJECT TITLE/LOCATION: ESTABLISHMENT OF REGIONAL ENERGY OPERATIONS CENTRE (EPOC) PHASE-1 REGIONAL OPER. BUILDING, SMT. CAMARGOS, VICT.	PREPARED BY: NARLEON B. RAJABO DRAWING III	CHECKED & SUBMITTED BY: SAMUEL TORRES CHIEF PLANNING DIVISION	REVIEWED & VERIFIED BY: FLORDELIZA ALER ASST. REGIONAL ENGINEER	RECOMMENDING APPROVAL: JOHN MARK S. TORRES REGIONAL ENGINEER	APPROVED BY: RICHARD R. PADILLA SUPERVISOR	SHT. CONTENTS SHT. NO.
---	--	---	---	--	--	---------------------------

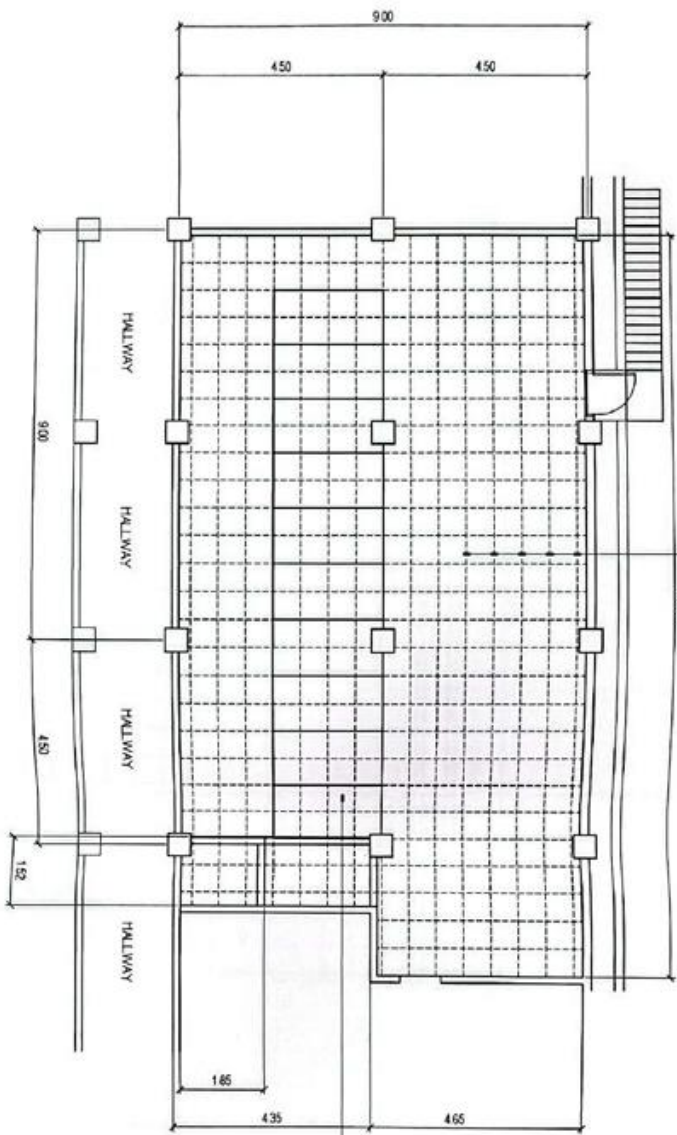

152x2
2" x 2" WOOD CEILING JOISTS 97/16 O.C.D. M. ON CENTER BOTHWAYS

15MM THK FIBER CEMENT BOARD

CEILING PLAN

SCALE
1:100 METERS

PROJECT TITLE/LOCATION ESTABLISHMENT OF PROVINCIAL EMERGENCY OPERATIONS CENTER(EDS) PHASE-I PROVINCIAL CAPITAL BUILDING, DIST. CAMARGES NORTE	PREPARED BY: NAPOLION B. SEARDO PROFESSOR III	CHECKED & SUBMITTED BY: SAMUEL T. DANITO CHIEF PLANNING DIVISION	REVIEWED & VERIFIED BY: FLORENZA P. JARA ASST. PROVINCIAL ENGINEER	RECOMMENDING AGENCY: JOHN MARCO S. TORRES PROVINCIAL ENGINEER	APPROVED BY: RUBEN R. PAPILLA GOVERNOR	SHT. CONTENTS / SHT. NO. AS SHOWN
---	---	--	--	---	--	--------------------------------------

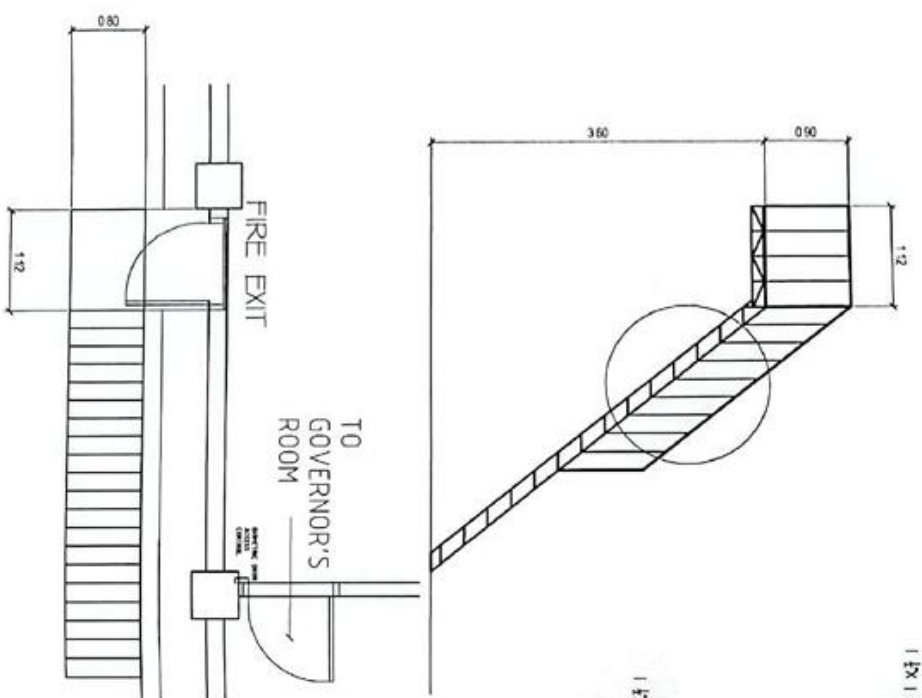

PLAN OF STEEL FIRE EXIT

SCALE: 1:50 METERS

PLAN OF STEP

SCALE: 1:20 METERS

SPOT DETAIL

SCALE: 1:20 METERS

PROJECT TITLE/LOCATION: ESTABLISHMENT OF PROVINCIAL EMERGENCY OPERATIONS CENTRE(S) PHASE-1 PROVINCIAL CAPITAL BUILDING DIST. CAMARINES NORTE		PREPARED BY: NAPALEON B. SALARDO DRAFTSMAN III	DESIGNED & SUBMITTED BY: SANTHE T. YARDO CHIEF PLANNING DIVISION	REVIEWED & VERIFIED BY: FLORDELIZA D. ALER ASST. PROVINCIAL ENGINEER	RECOMMENDING APPROVAL: JOHN MARINA S. TORIAS PROVINCIAL ENGINEER	APPROVED BY: RICHARD R. PADILLA ENGINEER	SHT. CONDITIONS, SHT. NO.	SHT. NO.
--	--	--	--	--	--	--	---------------------------	----------

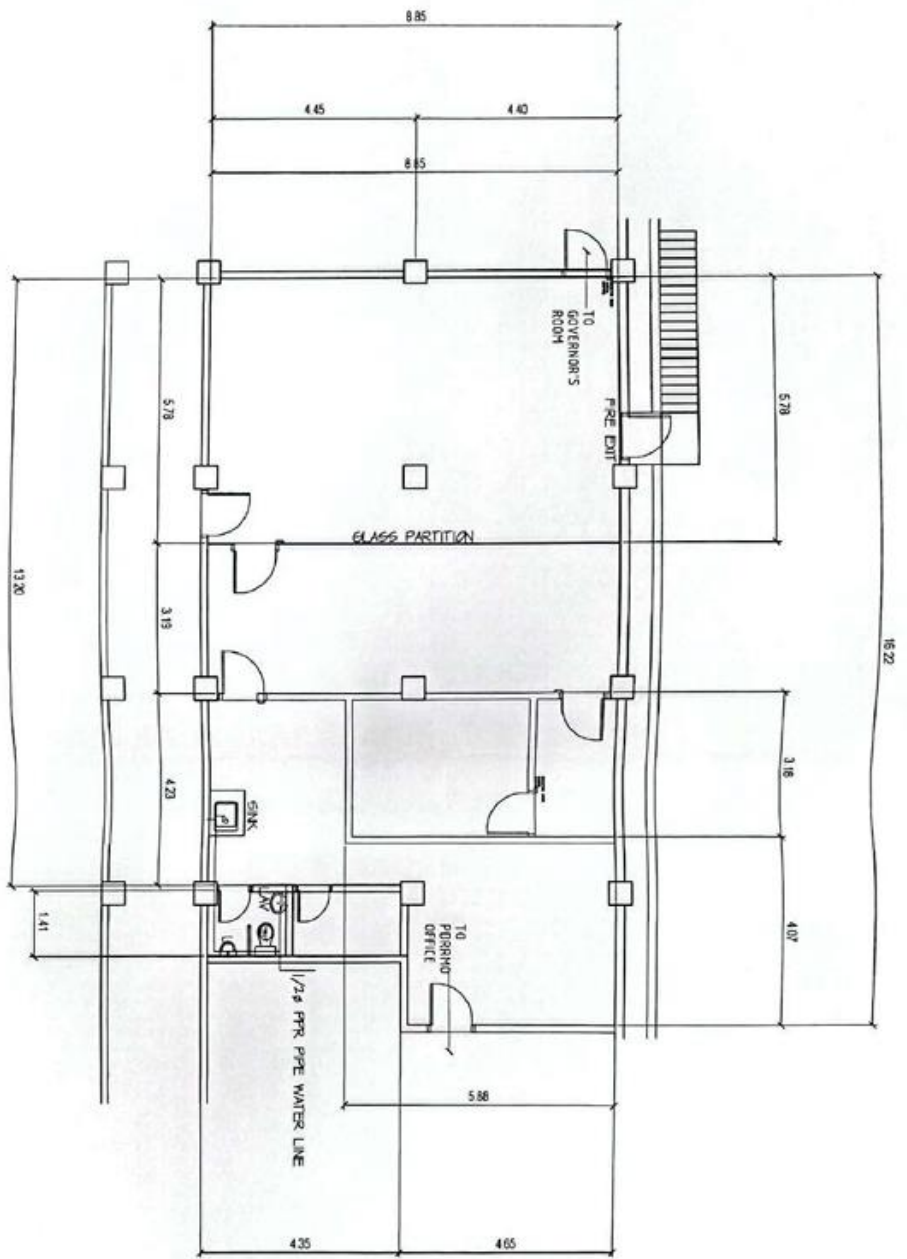

PLUMBING LAYOUT PLAN
SCALE 1:200 METERS

PROJECT TITLE/LOCATION: ESTABLISHMENT OF PROVINCIAL EMERGENCY OPERATIONS CENTER(EOP) PHASE-1 PROVINCIAL CAPITAL BUILDING DIST. CAMARINES NORTE	PREPARED BY: NAPOLION D. SARDADO DRAFTSMAN III	CHECKED & SUBMITTED BY: SAHICE T. VANTO CHIEF PLANNING DIVISION	REVIEWED & VERIFIED BY: FLORDELIZA D. VILLER ASST. PROVINCIAL ENGINEER	RECOMMENDED APPROVAL: JOHN WALTER S. TOBIAS PROVINCIAL ENGINEER	APPROVED BY: RICARDO R. PADILLA SUPERVISOR	SHT CONTENTS (SHT NO.)
						AS SHOWN

DRAWINGS AVAILABLE AT THE BAC OFFICE

Section VIII. Bill of Quantities

BILL OF QUANTITIES

ESTABLISHMENT OF PROVINCIAL EMERGENCY OPERATIONS CENTER (EOC) – PHASE I

Provincial Capitol Building, Daet, Camarines Norte

Item No.	Scope of Work	Unit	Quantity	Unit Price	TOTAL
I	ARCHITECTURAL WORKS				
A	DEMOLITION OF EXISTING STRUCTURES	LS	1.00		
B	FLOOR FINISHES	SQ.M.	136.38		
C	CEILING	SQ.M.	136.38		
D	WALLS PARTITION	SQ.M.	131.75		
E	EXTERIOR WALLS	SQ.M.	127.52		
F	CHB WALLS (ELECTRICAL ROOM)	SQ.M.	17.24		
G	DOORS AND WINDOWS	LS	1.00		
H	CARPENTRY	LS	1.00		
I	FIRE EXIT LADDER	LS	1.00		
II	PLUMBING WORKS				
A	WATER LINE	LS	1.00		
B	PLUMBING FIXTURES	LS	1.00		
III	ELECTRICAL WORKS				
A	WIRES	LS	1.00		
B	CONDUITS AND WIRING DEVICES	LS	1.00		
C	PANELBOARD, SERVICE ENTRY AND CIRCUIT BREAKER	LS	1.00		
D	ELECTRICAL FIXTURES	LS	1.00		
E	SERVICE ENTRANCE POLE	LS	1.00		
F	INSTALLATION OF 3-UNITS 50KVA TRANSFORMER WITH PRIVATE LINE	LS	1.00		
IV	PAINTING				
A	WALLS	SQ.M.	236.38		

B	CEILING	SQ.M.	136.38		
V	SPECIALS				
A	MAGNETIC DOOR ACCESS CONTROL WITH BIOMETRIC	LS	1.00		
B	RACK COMPONENTS FOR EMERGENCY OPERATIONS CENTER (EOC)	LS	1.00		
SPL-I	OCCUPATIONAL SAFETY & HEALTH PROGRAM	LOT	1.00		
SPL-II	PROJECT BILLBOARD AND SIGNBOARD	LOT	1.00		
TOTAL					

Amount in words:

Signature over Printed Name Date:

Section IX. Checklist of Technical and Financial Documents

Checklist of Technical and Financial Documents

I. TECHNICAL COMPONENT ENVELOPE

Class “A” Documents

Legal Documents

- (a) Valid PhilGEPS Registration Certificate (Platinum Membership) (all pages);

Technical Documents

- (b) Statement of the prospective bidder of all its ongoing government and private contracts, including contracts awarded but not yet started, if any, whether similar or not similar in nature and complexity to the contract to be bid; **and**
- (c) Statement of the bidder’s Single Largest Completed Contract (SLCC) similar to the contract to be bid, except under conditions provided under the rules; **and**
- (d) Special PCAB License in case of Joint Ventures; **and** registration for the type and cost of the contract to be bid; **and**
- (e) Original copy of Bid Security. If in the form of a Surety Bond, submit also a certification issued by the Insurance Commission; **or**
Original copy of Notarized Bid Securing Declaration; **and**
- (f) Project Requirements, which shall include the following:
 - a. Organizational chart for the contract to be bid;
 - c. List of contractor’s key personnel (*e.g.*, Project Manager, Project Engineers, Materials Engineers, and Foremen), to be assigned to the contract to be bid, with their complete qualification and experience data;
 - d. Key Personnel’s Certificate of Employment (notarized)
 - e. List of contractor’s major equipment units, which are owned, leased, and/or under purchase agreements, supported by proof of ownership or certification of availability of equipment from the equipment lessor/vendor for the duration of the project, as the case may be; **and**
- (g) Original duly signed Omnibus Sworn Statement (OSS);

and if applicable, Original Notarized Secretary’s Certificate in case of a corporation, partnership, or cooperative; or Original Special Power of Attorney of all members of the joint venture giving full power and authority to its officer to sign the OSS and do acts to represent the Bidder.

Financial Documents

- (h) The prospective bidder’s audited financial statements, showing, among others, the prospective bidder’s total and current assets and liabilities, stamped “received” by the BIR or its duly accredited and authorized institutions, for the preceding calendar year which should not be earlier than two (2) years from the date of bid submission; **and**
- (i) The prospective bidder’s computation of Net Financial Contracting Capacity (NFCC).

Class “B” Documents

- (j) If applicable, duly signed joint venture agreement (JVA) in accordance with RA No. 4566 and its IRR in case the joint venture is already in existence;
or
duly notarized statements from all the potential joint venture partners stating that they will enter into and abide by the provisions of the JVA in the instance that the bid is successful.

II. FINANCIAL COMPONENT ENVELOPE

- (k) Original of duly signed and accomplished Financial Bid Form; **and**

Other documentary requirements under RA No. 9184

- (l) Original of duly signed Bid Prices in the Bill of Quantities; **and**
- (m) Duly accomplished Detailed Estimates Form, including a summary sheet indicating the unit prices of construction materials, labor rates, and equipment rentals used in coming up with the Bid; **and**
- (n) Cash Flow by Quarter.

BID FORM

Date : _____

Project Identification No. : _____

To: HON. RICARTE R. PADILLA
Governor
PLGU- Camarines Norte

Having examined the Philippine Bidding Documents (PBDs) including the Supplemental or Bid Bulletin Numbers *[insert numbers]*, the receipt of which is hereby duly acknowledged, we, the undersigned, declare that:

- a. We have no reservation to the PBDs, including the Supplemental or Bid Bulletins, for the Procurement Project: *[insert project name]*;
- b. We offer to execute the Works for this Contract in accordance with the PBDs;
- c. The total price of our Bid in words and figures, excluding any discounts offered below is: *[insert information]*;
- d. The discounts offered and the methodology for their application are: **NONE**;
- e. The total bid price includes the cost of all taxes, such as, but not limited to: *(i) value added tax (VAT), (ii) income tax, (iii) local taxes, and (iv) other fiscal levies and duties*, which are itemized herein and reflected in the detailed estimates,
- f. Our Bid shall be valid within the period stated in the PBDs, and it shall remain binding upon us at any time before the expiration of that period;
- g. If our Bid is accepted, we commit to obtain a Performance Security in the amount of **30%** percent of the Contract Price for the due performance of the Contract, or a **Performance Securing Declaration** in lieu of the allowable forms of Performance

Security, subject to the terms and conditions of issued GPPB guidelines¹ for this purpose;

- h. We are not participating, as Bidders, in more than one Bid in this bidding process, other than alternative offers in accordance with the Bidding Documents;
- i. We understand that this Bid, together with your written acceptance thereof included in your notification of award, shall constitute a binding contract between us, until a formal Contract is prepared and executed; and
- j. We understand that you are not bound to accept the Lowest Calculated Bid or any other Bid that you may receive.
- k. We likewise certify/confirm that the undersigned, is the duly authorized representative of the bidder, and granted full power and authority to do, execute and perform any and all acts necessary to participate, submit the bid, and to sign and execute the ensuing contract for the *[insert project name]* of the **Provincial Government of Camarines Norte**.
- l. We acknowledge that failure to sign each and every page of this Bid Form, including the Bill of Quantities, shall be a ground for the rejection of our bid.

Name: _____

Legal Capacity: _____

Signature: _____

Duly authorized to sign the Bid for and behalf of: _____

Date: _____

REPUBLIC OF THE PHILIPPINES)

CITY OF _____) S.S.

BID SECURING DECLARATION

Project Identification No.: *[Insert number]*

To: ***HON. RICARTE R. PADILLA***
 Governor

 PLGU- Camarines Norte

I/We, the undersigned, declare that:

1. I/We understand that, according to your conditions, bids must be supported by a Bid Security, which may be in the form of a Bid Securing Declaration.
2. I/We accept that: (a) I/we will be automatically disqualified from bidding for any procurement contract with any procuring entity for a period of two (2) years upon receipt of your Blacklisting Order; and, (b) I/we will pay the applicable fine provided under Section 6 of the Guidelines on the Use of Bid Securing Declaration, within fifteen (15) days from receipt of the written demand by the procuring entity for the commission of acts resulting to the enforcement of the bid securing declaration under Sections 23.1(b), 34.2, 40.1 and 69.1, except 69.1(f), of the IRR of RA No. 9184; without prejudice to other legal action the government may undertake.
3. I/We understand that this Bid Securing Declaration shall cease to be valid on the following circumstances:
 - a. Upon expiration of the bid validity period, or any extension thereof pursuant to your request;
 - b. I am/we are declared ineligible or post-disqualified upon receipt of your notice to such effect, and (i) I/we failed to timely file a request for reconsideration or (ii) I/we filed a waiver to avail of said right; and
 - c. I am/we are declared the bidder with the Lowest Calculated Responsive Bid, and I/we have furnished the performance security and signed the Contract.

IN WITNESS WHEREOF, I/We have hereunto set my/our hand/s this _____ day of *[month]* *[year]* at *[place of execution]*.

[Insert NAME OF BIDDER OR ITS AUTHORIZED REPRESENTATIVE]

[Insert signatory's legal capacity]

Affiant

[Jurat]

[Format shall be based on the latest Rules on Notarial Practice]

Contract Agreement Form

[insert project name]

[not required to be submitted with the Bid, but it shall be submitted within ten (10) days after receiving the Notice of Award]

CONTRACT AGREEMENT

THIS AGREEMENT, made this *[insert date]* day of *[insert month]*, *[insert year]* between *[name and address of PROCURING ENTITY]* (hereinafter called the “Entity”) and *[name and address of Contractor]* (hereinafter called the “Contractor”).

WHEREAS, the Entity is desirous that the Contractor execute *[name and identification number of contract]* (hereinafter called “the Works”) and the Entity has accepted the Bid for *[contract price in words and figures in specified currency]* by the Contractor for the execution and completion of such Works and the remedying of any defects therein.

NOW THIS AGREEMENT WITNESSETH AS FOLLOWS:

1. In this Agreement, words and expressions shall have the same meanings as are respectively assigned to them in the Conditions of Contract hereinafter referred to.

2. The following documents as required by the 2016 revised Implementing Rules and Regulations of Republic Act No. 9184 shall be deemed to form and be read and construed as part of this Agreement, *viz.*:
 - a. Philippine Bidding Documents (PBDs);
 - i. Drawings/Plans;
 - ii. Specifications;
 - iii. Bill of Quantities;
 - iv. General and Special Conditions of Contract;
 - v. Supplemental or Bid Bulletins, if any;

 - b. Winning bidder’s bid, including the Eligibility requirements, Technical and Financial Proposals, and all other documents or statements submitted;

Bid form, including all the documents/statements contained in the Bidder’s bidding envelopes, as annexes, and all other documents submitted (*e.g.*, Bidder’s response

to request for clarifications on the bid), including corrections to the bid, if any, resulting from the Procuring Entity's bid evaluation;

- a. Performance Security;
 - b. Notice of Award of Contract and the Bidder's conforme thereto; and
 - c. Other contract documents that may be required by existing laws and/or the Procuring Entity concerned in the PBDs. **Winning bidder agrees that additional contract documents or information prescribed by the GPPB that are subsequently required for submission after the contract execution, such as the Notice to Proceed, Variation Orders, and Warranty Security, shall likewise form part of the Contract.**
3. In consideration for the sum of *[total contract price in words and figures]* or such other sums as may be ascertained, *[Named of the bidder]* agrees to *[state the object of the contract]* in accordance with his/her/its Bid.
 4. The *[Name of the procuring entity]* agrees to pay the above-mentioned sum in accordance with the terms of the Bidding.

IN WITNESS whereof the parties thereto have caused this Agreement to be executed the day and year first before written.

[Insert Name and Signature]

[Insert Name and Signature]

[Insert Signatory's Legal Capacity]

[Insert Signatory's Legal Capacity]

for:

for:

[Insert Name of Supplier]

[Insert Procuring Entity]

Acknowledgment

[Format shall be based on the latest Rules on Notarial Practice]

OMNIBUS SWORN STATEMENT

[shall be submitted with the Bid]

REPUBLIC OF THE PHILIPPINES)

CITY/MUNICIPALITY OF _____) S.S.

AFFIDAVIT

I, [Name of Affiant], of legal age, [Civil Status], [Nationality], and residing at [Address of Affiant], after having been duly sworn in accordance with law, do hereby depose and state that:

1. *[Select one, delete the other:]*

[If a sole proprietorship:] I am the sole proprietor or authorized representative of [Name of Bidder] with office address at [address of Bidder];

[If a partnership, corporation, cooperative, or joint venture:] I am the duly authorized and designated representative of [Name of Bidder] with office address at [address of Bidder];

2. *[Select one, delete the other:]*

[If a sole proprietorship:] As the owner and sole proprietor, or authorized representative of [Name of Bidder], I have full power and authority to do, execute and perform any and all acts necessary to participate, submit the bid, and to sign and execute the ensuing contract for [Name of the Project] of the [Name of the Procuring Entity], as shown in the attached duly notarized Special Power of Attorney;

[If a partnership, corporation, cooperative, or joint venture:] I am granted full power and authority to do, execute and perform any and all acts necessary to participate, submit the bid, and to sign and execute the ensuing contract for [Name of the Project] of the [Name of the Procuring Entity], as shown in the attached [state title of attached document showing proof of authorization (e.g., duly notarized Secretary's Certificate, Board/Partnership Resolution, or Special Power of Attorney, whichever is applicable)];

1. [Name of Bidder] is not "blacklisted" or barred from bidding by the Government of the Philippines or any of its agencies, offices, corporations, or Local Government Units, foreign government/foreign or international financing institution whose blacklisting rules have been recognized by the Government Procurement Policy Board, **by itself or by relation, membership, association, affiliation, or controlling interest with another**

blacklisted person or entity as defined and provided in the Uniform Guidelines on Blacklisting;

3. Each of the documents submitted in satisfaction of the bidding requirements is an authentic copy of the original, complete, and all statements and information provided therein are true and correct;
4. [Name of Bidder] is authorizing the Head of the Procuring Entity or its duly authorized representative(s) to verify all the documents submitted;

5. *[Select one, delete the rest:]*

[If a sole proprietorship:] The owner or sole proprietor is not related to the Head of the Procuring Entity, members of the Bids and Awards Committee (BAC), the Technical Working Group, and the BAC Secretariat, the head of the Project Management Office or the end-user unit, and the project consultants by consanguinity or affinity up to the third civil degree;

[If a partnership or cooperative:] None of the officers and members of [Name of Bidder] is related to the Head of the Procuring Entity, members of the Bids and Awards Committee (BAC), the Technical Working Group, and the BAC Secretariat, the head of the Project Management Office or the end-user unit, and the project consultants by consanguinity or affinity up to the third civil degree;

[If a corporation or joint venture:] None of the officers, directors, and controlling stockholders of [Name of Bidder] is related to the Head of the Procuring Entity, members of the Bids and Awards Committee (BAC), the Technical Working Group, and the BAC Secretariat, the head of the Project Management Office or the end-user unit, and the project consultants by consanguinity or affinity up to the third civil degree;

6. [Name of Bidder] complies with existing labor laws and standards; and
7. [Name of Bidder] is aware of and has undertaken the responsibilities as a Bidder in compliance with the Philippine Bidding Documents, which includes:
 - a. Carefully examining all of the Bidding Documents;
 - b. Acknowledging all conditions, local or otherwise, affecting the implementation of the Contract;
 - c. Making an estimate of the facilities available and needed for the contract to be bid, if any; and
 - a. Inquiring or securing Supplemental/Bid Bulletin(s) issued for the [Name of the

Project].

8. *[Name of Bidder]* did not give or pay directly or indirectly, any commission, amount, fee, or any form of consideration, pecuniary or otherwise, to any person or official, personnel or representative of the government in relation to any procurement project or activity.

9. **In case advance payment was made or given, failure to perform or deliver any of the obligations and undertakings in the contract shall be sufficient grounds to constitute criminal liability for Swindling (Estafa) or the commission of fraud with unfaithfulness or abuse of confidence through misappropriating or converting any payment received by a person or entity under an obligation involving the duty to deliver certain goods or services, to the prejudice of the public and the government of the Philippines pursuant to Article 315 of Act No. 3815 s. 1930, as amended, or the Revised Penal Code.**

IN WITNESS WHEREOF, I have hereunto set my hand this ___ day of ___, 20__ at _____, Philippines.

[Insert NAME OF BIDDER OR ITS AUTHORIZED REPRESENTATIVE]

[Insert signatory's legal capacity]

Affiant

[Jurat]

[Format shall be based on the latest Rules on Notarial Practice]

REPUBLIC OF THE PHILIPPINES)

CITY OF _____)

S.S.

AFFIDAVIT OF SITE INSPECTION

I, (Representative of the Bidder) , of legal age, (civil status) , Filipino and residing at (Address of the Representative) , under oath, hereby depose and say:

1. That I am the (Position in the Bidder) of the (Name of the Bidder) , with office at (Address of the Bidder) ;
2. That I have inspected the site for (Name of the Contract) , located at (location of the Contract) ;
3. That I am making this statement as part of the requirement for the Technical Proposal of the (Name of the Bidder) for (Name of the Contract) .

IN FAITH WHEREOF, I hereby affix my signature this day of , 20 at , Philippines.

AFFIANT

Witness:

SUBSCRIBED AND SWORN TO before me this , day of 20 , affiant exhibiting to me his/her Community Tax Certificate No. issued on at , Philippines.

(Notary Public)

Until _____
PTR No. _____
Date _____
Place _____
TIN _____

Doc. No. _____
Page No. _____
Book No. _____
Series of _____

Bids and Awards Committee
Provincial Government of Camarines Norte

Provincial Capitol Building
Daet, Camarines Norte

AFFIDAVIT OF AVAILABILITY OF KEY PERSONNEL AND EQUIPMENT

I, _____ of legal age, Filipino, married/single/widow, and, a resident of _____, owner/proprietor of _____ after having been duly sworn to in accordance with law, depose and declare;

1. That I/we have engage and contracted the service of Engr. _____ (herein called the Resident/Project Engineer), a Registered Civil Engineer with Professional License No. _____ issued on _____ and who has paid his Professional Tax for the Current Year _____;
2. That the said Engineer shall be appointed and designated as our Resident/Project Engineer to personally manage and supervise the construction.
3. That the said Engineer shall employ the best care, skill and ability in supervising the project in accordance with the Contract Agreement, contract plan, and other provisions embodied in the proposed contract;
4. That the said Engineer shall be personally present at the jobsite to supervise all the phase of the construction work at all time;
5. That all other key personnel are available for the project;
6. That equipment needed for the project, are likewise available;
7. That any willful violation on my/our part of the herein condition may prejudice my/our standing as a reliable contractor in future biddings in your office.

IN WITNESS WHEREOF, I have here unto set my hands this _____ day of _____, 20____ at _____, Philippines.

Affiant's Printed Name and Signature

WITNESSES:

SUBSCRIBED AND SWORN to before me this _____ day of _____, 20____ affiant exhibiting to me his/her Resident Certificate No.: _____ issued _____ at _____.

Notary Public

Doc No.: _____
Page No.: _____
Book No.: _____
Series of: _____

Bids and Awards Committee
 Provincial Government of Camarines Norte
 Provincial Capitol Building
 Daet, Camarines Norte

KEY PERSONNEL'S CERTIFICATE OF EMPLOYMENT

_____ *Date*

Dear Sir / Madame:

I am (Name of Nominee) a Licensed Engineer with Professional License No. _____ issued on (date of issuance) at (place of issuance) .

I hereby certify that (Name of Bidder) has engaged my services as (Designation) for (Name of the Contract) , if awarded to it.

As (Designation) , I supervised the following completed projects similar to the contract under bidding:

<u>NAME OF PROJECT</u>	<u>OWNER</u>	<u>COST</u>	<u>DATE COMPLETED</u>
_____	_____	_____	_____
_____	_____	_____	_____
_____	_____	_____	_____
_____	_____	_____	_____

At present, I am supervising the following projects:

<u>NAME OF PROJECT</u>	<u>OWNER</u>	<u>COST</u>	<u>DATE COMPLETED</u>
_____	_____	_____	_____
_____	_____	_____	_____
_____	_____	_____	_____
_____	_____	_____	_____

In case of my separation for any reason whatsoever from the above-mentioned Contractor, I shall notify the (Name of the Procuring Entity) at least twenty one (21) days before the effective date of my separation.

As (Designation) , I know I will have to stay in the job site all the time to supervise and manage the Contract works to the best of my ability, and aware that I am authorized to handle only one (1) contract at

a time.

I do not allow the use of my name for the purpose of enabling the above-mentioned Contractor to qualify for the Contract without any firm commitment on my part to assume the post of (Designation) therefore, if the contract is awarded to him since I understand that to do so will be a sufficient ground for my disqualification as (Designation) in any future (Name of the Procuring Entity) bidding or employment with any Contractor doing business with the (Name of the Procuring Entity).

(Signature of Engineer)

WITNESSES:

DRY SEAL

Republic of the Philippines)
_____) S.S.

SUBSCRIBED AND SWORN TO before me this _____ day of _____ 20__ affiant exhibiting to me his Residence Certificate No. _____ issued on _____ at _____.

NOTARY PUBLIC
PTR No.: _____
Issued at: _____
Issued on: _____
Until 31 December 20____

Doc. No.: _____;
Page No. : _____;
Book No.: _____;
Series of _____;



Republic of the Philippines
DEPARTMENT OF PUBLIC WORKS AND HIGHWAYS
OFFICE OF THE SECRETARY
Manila

OPW 12 2/16/16
10-10-2016

07 OCT 2016

DEPARTMENT ORDER)

NO.)

Series of 2016)

197

SUBJECT: Revised Guidelines in the
Preparation of Approved Budget for
the Contract (ABC)

The following policies, rules and procedures relative to the preparation of the "Approved Budget for the Contract" (ABC) previously prescribed under Department Order No. 22, Series of 2015, are hereby revised/reiterated.

The ABC shall be prepared on the basis of the design plans for the project which has been duly approved by authorized officials in accordance with existing regulations.

All items of work to be used in preparing the ABC shall conform to the Standard Specifications for Highways, Bridges and Airports, revised 2013, Standard Specifications for Public Works Structures, 1995, and approved Special Specifications for the project.

The ABC shall be composed of the Direct Cost and the Indirect Cost.

A. The Direct Cost shall consist of the following:

A.1 Cost of materials to be used in doing the work item called for, which shall include, inter alia, the following:

A.1.1 Cost at source, including processing, crushing, stockpiling, loading, royalties, local taxes, construction and/or maintenance of haul roads, etc.

A.1.2 Expenses for hauling to project site.

A.1.3 Handling expenses.

A.1.4 Storage expenses.

A.1.5 Allowance for waste and/or losses, not to exceed 5% of materials requirement.

A.2 Cost of Labor:

A.2.1 Salaries and wages, as authorized by the Department of Labor and Employment.

A.2.2 Fringe benefits, such as vacation and sick leaves, benefits under the Workmen's Compensation Act, GSIS and/or SSS contributions, allowances, 13th month pay, bonuses, etc.

A.3 Equipment Expenses:

A.3.1 Rental rates of equipment shall be based on the prevailing "Association of Carriers and Equipment Lessors, (ACEL) Inc." approved for use by the DPWH (Presently it is the 2014 ACEL Rates). Rental rates of equipment not indicated in the ACEL booklet shall be taken from the rental rates prepared by the Bureau of Equipment. For simplicity in computation, the operated rental rates are preferred over the bare rental rates as the former includes operator's wages, fringe benefits, fuel, oil, lubricants and equipment maintenance. The make, model and capacity of the equipment should be indicated in the detailed unit cost analysis.

A.3.2 Mobilization and demobilization shall be treated as a separate pay item. It shall be computed based on the equipment requirements of the project stipulated in the proposal and contract booklet. Mobilization and demobilization shall not exceed 1% of the Estimated Direct Cost (EDC) of the civil works items. However, in special cases wherein requirements for mobilization/demobilization exceed 1%, an approval to utilize the actual computed mobilization/demobilization cost shall be secured from the concerned Undersecretary for Operations.

A.4 Cost for Permits, Clearances and other Government Taxes (i.e. MMDA Permit, LGU Permits, Bureau of Fire Protection Clearance, etc.) shall be included in the cost under Part B - Other General Requirements of the Program of Works (POW) and Estimate/ABC.

B. The Indirect Cost shall consist of the following:

B.1 Overhead Expenses - ranges from 7 - 11% of the EDC, which includes the following:

B.1.1 Engineering and Administrative Supervision.

B.1.2 Transportation allowances.

B.1.3 Office Expenses, e.g., for office equipment and supplies, power and water consumption, communication and maintenance.

B.1.4 Premium on Contractor's All Risk Insurance (CART).

B.1.5 Financing Cost.

B.1.5.1 Premium on Bid Security

B.1.5.2 Premium on Performance Security

B.1.5.3 Premium on Surety for Advance Payment

B.1.5.4 Premium on Warranty Bond (one year)

B.2 Contingencies - ranges from 0.5 - 3% of the EDC. These include expenses for meetings, coordination with other stakeholders, billboards (excluding Project Billboard which is a pay item under the General Requirements), stages during ground breaking & inauguration ceremonies, and other unforeseen events.

- B.3 Miscellaneous Expenses – ranges from 0.5 - 1% of the EDC. These include laboratory tests for quality control and plan preparation.
- B.4 Contractor's Profit Margin – shall be 8% of the EDC for projects above P5Million and 10% for projects P5Million and below.
- B.5 VAT Component – shall be 5% of the sum of the EDC, OCM and Profit.
- B.6 The following items shall not be subjected to OCM and Profit mark-up:
 - B.6.1 Mobilization and demobilization
 - B.6.2 Provision of Service Vehicle
 - B.6.3 Permits and Clearances
- B.7 The following non-civil works items shall not be subjected to OCM mark-up:
 - B.7.1 Field/Laboratory Office & Living Quarters (Rental Basis)
 - B.7.2 Furnishing of Furniture, Laboratory Equipment, Survey Equipment and Consumables
 - B.7.3 Assistance to the Engineers
 - B.7.4 Photographs
 - B.7.5 Health and Safety
 - B.7.6 Traffic Management
 - B.7.7 Environmental Compliance
 - B.7.8 Communication Equipment, etc.

NOTE: For the percentage to be used for Nos. B.1, B.2 and B.3, see OCM (Overhead, Contingencies and Miscellaneous) column in the tabulation below.

ESTIMATED DIRECT COST (EDC)	INDIRECT COST % FOR OCM AND PROFIT		TOTAL INDIRECT COST % FOR OCM AND PROFIT
	OCM (% OF EDC)	PROFIT (% OF EDC)	
Up to P5Million	15	10	25
Above P5M up to P50M	12	8	20
Above P50M up to P150M	10	8	18
Above P150M	8	8	16

C. The prescribed format for the calculation of the ABC is shown in Attachment "A".

- C.1 Instructions for filling-up the format:

- C.1.1 Columns (1) to (4) are self-explanatory.
 - C.1.2 Column (5) is the EDC of the work item as calculated and reflected in the cost analysis prepared by the Estimator.
 - C.1.3 Columns (6) and (7) are the mark-ups in percent for OCM and profit.
 - C.1.4 Column (8) is the total mark-up, which is the sum of the percentages under columns (6) and (7).
 - C.1.5 Column (9) is the Peso value of the total mark-up. It is determined by multiplying the total mark-up on percent in column (8) with the EDC (column 5).
 - C.1.6 Column (10) is the VAT component which is 5% of the sum of columns (5) and (9).
 - C.1.7 Column (11) is the total estimated Indirect Cost which is the sum of columns (9) and (10).
 - C.1.8 Column (12) is the total estimated Total Cost or the sum of columns (5) and (11).
 - C.1.9 Column (13) is the unit cost for each item of works, determined by dividing the estimated Total Cost in column (12) by its total quantity in column (3).
- C.2 Procedures in preparing, processing and corresponding signatories specified under Department Order No. 163, Series of 2015 in the preparation of Program of Work (POW) and Approved Budget for the Contract (ABC) shall be observed.

Since the ABC is to be compared with the Contractor's bid and is the ceiling for acceptable bid prices in accordance with the provision of R.A. 9184, the ABC should be based on the approved Bidding Documents for the contract which contain the same work items and quantities as those to be used by the contractors in preparing their bid.

DPWH estimators shall continuously update their information/statistics on market prices of all construction inputs submitted for incorporation in the quarterly Construction Materials Price Database (CMPD). All assumptions in generating the estimate should be shown in the cost analysis.

In all cases, estimates for special items of work (SPL) should be accompanied with plans and specifications, methods of construction, measurements and payments duly approved by the Bureau of Research and Standards (BRS).

This Order shall take effect immediately and shall supersede Department Order No. 22, Series of 2015.



MARK A. VILLAR
Acting Secretary

6.1 WRD/PCA

Department of Public Works and Highways
Office of the Secretary



WIN6W01961

