



**PROVINCIAL GOVERNMENT OF CAMARINES NORTE
DAET**

**CONSTRUCTION OF FARM TO
MARKET ROAD**

Brgy. Cobangbang, Daet,
Camarines Norte

March 18, 2024

Preface

These Philippine Bidding Documents (PBDs) for the procurement of Infrastructure Projects (hereinafter referred to also as the “Works”) through Competitive Bidding have been prepared by the Government of the Philippines for use by all branches, agencies, departments, bureaus, offices, or instrumentalities of the government, including government-owned and/or -controlled corporations, government financial institutions, state universities and colleges, local government units, and autonomous regional government. The procedures and practices presented in this document have been developed through broad experience, and are for mandatory use in projects that are financed in whole or in part by the Government of the Philippines or any foreign government/foreign or international financing institution in accordance with the provisions of the 2016 revised Implementing Rules and Regulations (IRR) of Republic Act (RA) No. 9184.

The PBDs are intended as a model for admeasurements (unit prices or unit rates in a bill of quantities) types of contract, which are the most common in Works contracting.

The Bidding Documents shall clearly and adequately define, among others: (i) the objectives, scope, and expected outputs and/or results of the proposed contract; (ii) the eligibility requirements of Bidders; (iii) the expected contract duration; and (iv) the obligations, duties, and/or functions of the winning Bidder.

Care should be taken to check the relevance of the provisions of the PBDs against the requirements of the specific Works to be procured. If duplication of a subject is inevitable in other sections of the document prepared by the Procuring Entity, care must be exercised to avoid contradictions between clauses dealing with the same matter.

Moreover, each section is prepared with notes intended only as information for the Procuring Entity or the person drafting the Bidding Documents. They shall not be included in the final documents. The following general directions should be observed when using the documents:

- a. All the documents listed in the Table of Contents are normally required for the procurement of Infrastructure Projects. However, they should be adapted as necessary to the circumstances of the particular Project.
- b. Specific details, such as the “*name of the Procuring Entity*” and “*address for bid submission*,” should be furnished in the Instructions to Bidders, Bid Data Sheet, and Special Conditions of Contract. The final documents should contain neither blank spaces nor options.
- c. This Preface and the footnotes or notes in italics included in the Invitation to Bid, BDS, General Conditions of Contract, Special Conditions of Contract, Specifications, Drawings, and Bill of Quantities are not part of the text of the final document, although they contain instructions that the Procuring Entity should strictly follow.
- d. The cover should be modified as required to identify the Bidding Documents as to the names of the Project, Contract, and Procuring Entity, in addition to date of issue.

- e. Modifications for specific Procurement Project details should be provided in the Special Conditions of Contract as amendments to the Conditions of Contract. For easy completion, whenever reference has to be made to specific clauses in the Bid Data Sheet or Special Conditions of Contract, these terms shall be printed in bold typeface on Sections I (Instructions to Bidders) and III (General Conditions of Contract), respectively.
- f. For guidelines on the use of Bidding Forms and the procurement of Foreign-Assisted Projects, these will be covered by a separate issuance of the Government Procurement Policy Board.

TABLE OF CONTENTS

GLOSSARY OF	5
TERMS, ABBREVIATIONS, AND ACRONYMS.....	5
SECTION I. INVITATION TO BID.....	8
SECTION II. INSTRUCTIONS TO BIDDERS.....	11
1. Scope of Bid.....	12
2. Funding Information	12
3. Bidding Requirements.....	12
4. Corrupt, Fraudulent, Collusive, Coercive, and Obstructive Practices	13
5. Eligible Bidders.....	13
6. Origin of Associated Goods	13
7. Subcontracts	13
8. Pre-Bid Conference	14
9. Clarification and Amendment of Bidding Documents.....	14
10. Documents Comprising the Bid: Eligibility and Technical Components.....	14
11. Documents Comprising the Bid: Financial Component	15
12. Alternative Bids	15
13. Bid Prices	15
14. Bid and Payment Currencies	16
15. Bid Security.....	16
16. Sealing and Marking of Bids.....	16
17. Deadline for Submission of Bids	16
18. Opening and Preliminary Examination of Bids	16
19. Detailed Evaluation and Comparison of Bids.....	17
20. Post Qualification.....	17
21. Signing of the Contract	17
SECTION III. BID DATA SHEET.....	18
SECTION IV. GENERAL CONDITIONS OF CONTRACT.....	21
1. Scope of Contract.....	22
2. Sectional Completion of Works	22
3. Possession of Site.....	22
4. The Contractor’s Obligations	22
5. Performance Security	23

6.	Site Investigation Reports	23
7.	Warranty.....	23
8.	Liability of the Contractor.....	23
9.	Termination for Other Causes	23
10.	Dayworks	24
11.	Program of Work.....	24
12.	Instructions, Inspections and Audits	24
13.	Advance Payment.....	24
14.	Progress Payments	24
15.	Operating and Maintenance Manuals.....	24
SECTION V. SPECIAL CONDITIONS OF CONTRACT.....		26
SECTION VI. SPECIFICATIONS.....		28
ITEM 100 – CLEARING AND GRUBBING		29
ITEM 101 – REMOVAL OF STRUCTURES AND OBSTRUCTION.....		31
ITEM 102 – EXCAVATION.....		33
ITEM 103 – STRUCTURE EXCAVATION		38
ITEM 104 – EMBANKMENT		44
ITEM 105 – SUBGRADE PREPARATION.....		51
ITEM 200 – AGGREGATE SUBBASE COURSE.....		55
ITEM 311 – PORTLAND CEMENT CONCRETE PAVEMENT		60
ITEM 506 – STONE MASONRY		88
SECTION VII. DRAWINGS.....		90
SECTION VIII. BILL OF QUANTITIES.....		106
SECTION IX. CHECKLIST OF TECHNICAL AND FINANCIAL DOCUMENTS.....		108
BID FORM		111
BID SECURING DECLARATION		113
CONTRACT AGREEMENT FORM.....		114
OMNIBUS SWORN STATEMENT		116
AFFIDAVIT OF SITE INSPECTION		119
AFFIDAVIT OF AVAILABILITY OF KEY PERSONNEL AND EQUIPMENT		120
KEY PERSONNEL’S CERTIFICATE OF EMPLOYMENT		121
DPWH DEPARTMENT ORDER 197 S. 2016.....		123

Glossary of Terms, Abbreviations, and Acronyms

ABC – Approved Budget for the Contract.

ARCC – Allowable Range of Contract Cost.

BAC – Bids and Awards Committee.

Bid – A signed offer or proposal to undertake a contract submitted by a bidder in response to and in consonance with the requirements of the bidding documents. Also referred to as *Proposal* and *Tender*. (2016 revised IRR, Section 5[c])

Bidder – Refers to a contractor, manufacturer, supplier, distributor and/or consultant who submits a bid in response to the requirements of the Bidding Documents. (2016 revised IRR, Section 5[d])

Bidding Documents – The documents issued by the Procuring Entity as the bases for bids, furnishing all information necessary for a prospective bidder to prepare a bid for the Goods, Infrastructure Projects, and/or Consulting Services required by the Procuring Entity. (2016 revised IRR, Section 5[e])

BIR – Bureau of Internal Revenue.

BSP – Bangko Sentral ng Pilipinas.

CDA – Cooperative Development Authority.

Consulting Services – Refer to services for Infrastructure Projects and other types of projects or activities of the GOP requiring adequate external technical and professional expertise that are beyond the capability and/or capacity of the GOP to undertake such as, but not limited to: (i) advisory and review services; (ii) pre-investment or feasibility studies; (iii) design; (iv) construction supervision; (v) management and related services; and (vi) other technical services or special studies. (2016 revised IRR, Section 5[i])

Contract – Refers to the agreement entered into between the Procuring Entity and the Supplier or Manufacturer or Distributor or Service Provider for procurement of Goods and Services; Contractor for Procurement of Infrastructure Projects; or Consultant or Consulting Firm for Procurement of Consulting Services; as the case may be, as recorded in the Contract Form signed by the parties, including all attachments and appendices thereto and all documents incorporated by reference therein.

Contractor – is a natural or juridical entity whose proposal was accepted by the Procuring Entity and to whom the Contract to execute the Work was awarded. Contractor as used in these Bidding Documents may likewise refer to a supplier, distributor, manufacturer, or consultant.

CPI – Consumer Price Index.

DOLE – Department of Labor and Employment.

DTI – Department of Trade and Industry.

Foreign-funded Procurement or Foreign-Assisted Project – Refers to procurement whose funding source is from a foreign government, foreign or international financing institution as specified in the Treaty or International or Executive Agreement. (2016 revised IRR, Section 5[b]).

GFI – Government Financial Institution.

GOCC – Government-owned and/or –controlled corporation.

Goods – Refer to all items, supplies, materials and general support services, except Consulting Services and Infrastructure Projects, which may be needed in the transaction of public businesses or in the pursuit of any government undertaking, project or activity, whether in the nature of equipment, furniture, stationery, materials for construction, or personal property of any kind, including non-personal or contractual services such as the repair and maintenance of equipment and furniture, as well as trucking, hauling, janitorial, security, and related or analogous services, as well as procurement of materials and supplies provided by the Procuring Entity for such services. The term “related” or “analogous services” shall include, but is not limited to, lease or purchase of office space, media advertisements, health maintenance services, and other services essential to the operation of the Procuring Entity. (2016 revised IRR, Section 5[r])

GOP – Government of the Philippines.

Infrastructure Projects – Include the construction, improvement, rehabilitation, demolition, repair, restoration or maintenance of roads and bridges, railways, airports, seaports, communication facilities, civil works components of information technology projects, irrigation, flood control and drainage, water supply, sanitation, sewerage and solid waste management systems, shore protection, energy/power and electrification facilities, national buildings, school buildings, hospital buildings, and other related construction projects of the government. Also referred to as *civil works or works*. (2016 revised IRR, Section 5[u])

LGUs – Local Government Units.

NFCC – Net Financial Contracting Capacity.

NGA – National Government Agency.

PCAB – Philippine Contractors Accreditation Board.

PhilGEPS - Philippine Government Electronic Procurement System.

Procurement Project – refers to a specific or identified procurement covering goods, infrastructure project or consulting services. A Procurement Project shall be described, detailed, and scheduled in the Project Procurement Management Plan prepared by the agency which shall be consolidated in the procuring entity's Annual Procurement Plan. (GPPB Circular No. 06-2019 dated 17 July 2019)

PSA – Philippine Statistics Authority.

SEC – Securities and Exchange Commission.

SLCC – Single Largest Completed Contract.

UN – United Nations.

Section I. Invitation to Bid



Republic of the Philippines
PROVINCE OF CAMARINES NORTE
BIDS AND AWARDS COMMITTEE



**Invitation to Bid for the Construction of Farm to Market Road,
Brgy. Cobangbang, Daet, Camarines Norte**

1. The *Provincial Government of Camarines Norte*, through the *PEO – 20% Development Fund AB2024* intends to apply the sum of *Three Million Nine Hundred Ninety-Eight Thousand Seven Hundred Twenty-Three Pesos and Forty-Seven Centavos (P3,998,723.47)* being the Approved Budget for the Contract (ABC) to payments under the contract for the *Construction of Farm to Market Road, Brgy. Cobangbang, Daet, Camarines Norte*. Bids received in excess of the ABC shall be automatically rejected at bid opening.
2. The *Provincial Government of Camarines Norte* now invites bids for the *Concreting of 312.50LM x 4.00m x 0.20m road with 195.39 cu.m. stone masonry*. Completion of the Works is required *120 CD*. Bidders should have completed a contract similar to the Project. The description of an eligible bidder is contained in the Bidding Documents, particularly, in Section II (Instructions to Bidders).
3. Bidding will be conducted through open competitive bidding procedures using non-discretionary “pass/fail” criterion as specified in the 2016 Revised Implementing Rules and Regulations (IRR) of Republic Act 9184 (RA 9184), otherwise known as the “Government Procurement Reform Act.”
4. Bidders may obtain further information from the *Provincial Government of Camarines Norte* and inspect the Bidding Documents at the address given below from *8:00a.m. to 5:00p.m., Monday to Friday*.
5. A complete set of Bidding Documents may be acquired by interested bidders *March 18 – April 11, 2024* at the *Provincial Capitol Building, Daet, Camarines Norte* and from the website of the *Philippine Government Electronic Procurement System (PhilGEPS)* upon payment of the applicable fee for the Bidding Documents, pursuant to the latest Guidelines issued by the GPPB, in the amount of *Five Thousand Pesos (P5,000.00)*. The Procuring Entity shall allow the bidder to present its proof of payment for the fees in person.
6. The *Provincial Government of Camarines Norte* will hold a Pre-Bid Conference on *March 26, 2024, 2:00p.m.* at the *new BAC Conference Office, at the back of Agro-Sports Center, J. Lukban Street, Daet, Camarines Norte*, which shall be open to prospective bidders.
7. Bids must be duly received by the BAC Secretariat at the address below on or before *April 11, 2024 at 1:30p.m.* Late bids shall not be accepted.
8. All bids must be accompanied by a bid security in any of the acceptable forms and in the amount stated in ITB Clause 16.
9. Bid opening shall be on *April 11, 2024, 2:00 p.m.* at the *new BAC Conference Office, at the back of Agro-Sports Center, J. Lukban Street, Daet, Camarines Norte*. Bids will be opened in the presence of the bidders’ representatives who choose to attend the activity.

10. The *Provincial Government of Camarines Norte* reserves the right to reject any and all bids, declare a failure of bidding, or not award the contract at any time prior to contract award in accordance with Section 35.6 and 41 of RA 9184 of the revised IRR of RA 9184 without thereby incurring any liability to the affected bidder or bidders.

11. For further information, please refer to:

ATTY. ARCHIMEDES O. YANTO
Provincial Legal Officer / BAC Chairperson
Provincial Capitol Bldg., Daet, Camarines Norte
(054) 885-1474

12. You may visit the website:

Philippine Government Electronic Procurement System (PhilGEPS)



ATTY. ARCHIMEDES O. YANTO
Provincial Legal Officer / BAC Chairperson

Section II. Instructions to Bidders

1. Scope of Bid

The Procuring Entity, *[indicate name]* invites Bids for the *[insert Procurement Project]*, with Project Identification Number *[indicate number]*.

[Note: The Project Identification Number is assigned by the Procuring Entity based on its own coding scheme and is not the same as the PhilGEPS reference number, which is generated after the posting of the bid opportunity on the PhilGEPS website.]

The Procurement Project (referred to herein as “Project”) is for the construction of Works, as described in Section VI (Specifications).

2. Funding Information

2.1. The GOP through the source of funding as indicated below for *[indicate funding year]* in the amount of *[indicate amount]*.

2.2. The source of funding is:

[If an early procurement activity, select one and delete others:]

- a. NGA, the National Expenditure Program.
- b. GOCC and GFIs, the proposed Corporate Operating Budget.
- c. LGUs, the proposed Local Expenditure Program.

[If not an early procurement activity, select one and delete others:]

- a. NGA, the General Appropriations Act or Special Appropriations.
- b. GOCC and GFIs, the Corporate Operating Budget.
- c. LGUs, the Annual or Supplemental Budget, as approved by the Sanggunian.

3. Bidding Requirements

The Bidding for the Project shall be governed by all the provisions of RA No. 9184 and its 2016 revised IRR, including its Generic Procurement Manual and associated policies, rules and regulations as the primary source thereof, while the herein clauses shall serve as the secondary source thereof.

Any amendments made to the IRR and other GPPB issuances shall be applicable only to the ongoing posting, advertisement, or invitation to bid by the BAC through the issuance of a supplemental or bid bulletin.

The Bidder, by the act of submitting its Bid, shall be deemed to have inspected the site, determined the general characteristics of the contracted Works and the conditions for this Project, such as the location and the nature of the work; (b) climatic conditions; (c) transportation facilities; (c) nature and condition of the terrain, geological conditions

at the site communication facilities, requirements, location and availability of construction aggregates and other materials, labor, water, electric power and access roads; and (d) other factors that may affect the cost, duration and execution or implementation of the contract, project, or work and examine all instructions, forms, terms, and project requirements in the Bidding Documents.

4. Corrupt, Fraudulent, Collusive, Coercive, and Obstructive Practices

The Procuring Entity, as well as the Bidders and Contractors, shall observe the highest standard of ethics during the procurement and execution of the contract. They or through an agent shall not engage in corrupt, fraudulent, collusive, coercive, and obstructive practices defined under Annex “I” of the 2016 revised IRR of RA No. 9184 or other integrity violations in competing for the Project.

5. Eligible Bidders

5.1. Only Bids of Bidders found to be legally, technically, and financially capable will be evaluated.

5.2. The Bidder must have an experience of having completed a Single Largest Completed Contract (SLCC) that is similar to this Project, equivalent to at least fifty percent (50%) of the ABC adjusted, if necessary, by the Bidder to current prices using the PSA’s CPI, except under conditions provided for in Section 23.4.2.4 of the 2016 revised IRR of RA No. 9184.

A contract is considered to be “similar” to the contract to be bid if it has the major categories of work stated in the **BDS**.

5.3. For Foreign-funded Procurement, the Procuring Entity and the foreign government/foreign or international financing institution may agree on another track record requirement, as specified in the Bidding Document prepared for this purpose.

5.4. The Bidders shall comply with the eligibility criteria under Section 23.4.2 of the 2016 IRR of RA No. 9184.

6. Origin of Associated Goods

There is no restriction on the origin of Goods other than those prohibited by a decision of the UN Security Council taken under Chapter VII of the Charter of the UN.

7. Subcontracts

7.1. The Bidder may subcontract portions of the Project to the extent allowed by the Procuring Entity as stated herein, but in no case more than fifty percent (50%) of the Project.

The Procuring Entity has prescribed that:
[Select one, delete other/s]

- a. Subcontracting is allowed. The portions of Project and the maximum percentage allowed to be subcontracted are indicated in the **BDS**, which shall not exceed fifty percent (50%) of the contracted Works.
 - b. Subcontracting is not allowed.
- 7.1. *[If Procuring Entity has determined that subcontracting is allowed during the bidding , state:]* The Bidder must submit together with its Bid the documentary requirements of the subcontractor(s) complying with the eligibility criterial stated in **ITB** Clause 5 in accordance with Section 23.4 of the 2016 revised IRR of RA No. 9184 pursuant to Section 23.1 thereof.
- 7.2. *[If subcontracting is allowed during the contract implementation stage, state:]* The Supplier may identify its subcontractor during the contract implementation stage. Subcontractors identified during the bidding may be changed during the implementation of this Contract. Subcontractors must submit the documentary requirements under Section 23.1 of the 2016 revised IRR of RA No. 9184 and comply with the eligibility criteria specified in **ITB** Clause 5 to the implementing or end-user unit.
- 7.3. Subcontracting of any portion of the Project does not relieve the Contractor of any liability or obligation under the Contract. The Supplier will be responsible for the acts, defaults, and negligence of any subcontractor, its agents, servants, or workmen as fully as if these were the Contractor’s own acts, defaults, or negligence, or those of its agents, servants, or workmen.

8. Pre-Bid Conference

The Procuring Entity will hold a pre-bid conference for this Project on the specified date and time and either at its physical address *{[insert if applicable]}* and/or through video conferencing/webcasting } as indicated in paragraph 6 of the **IB**.

9. Clarification and Amendment of Bidding Documents

Prospective bidders may request for clarification on and/or interpretation of any part of the Bidding Documents. Such requests must be in writing and received by the Procuring Entity, either at its given address or through electronic mail indicated in the **IB**, at least ten (10) calendar days before the deadline set for the submission and receipt of Bids.

10. Documents Comprising the Bid: Eligibility and Technical Components

- 10.1. The first envelope shall contain the eligibility and technical documents of the Bid as specified in **Section IX. Checklist of Technical and Financial Documents**.
- 10.2. If the eligibility requirements or statements, the bids, and all other documents for submission to the BAC are in foreign language other than English, it must

be accompanied by a translation in English, which shall be authenticated by the appropriate Philippine foreign service establishment, post, or the equivalent office having jurisdiction over the foreign bidder's affairs in the Philippines. For Contracting Parties to the Apostille Convention, only the translated documents shall be authenticated through an apostille pursuant to GPPB Resolution No. 13-2019 dated 23 May 2019. The English translation shall govern, for purposes of interpretation of the bid.

- 10.3. A valid PCAB License is required, and in case of joint ventures, a valid special PCAB License, and registration for the type and cost of the contract for this Project. Any additional type of Contractor license or permit shall be indicated in the **BDS**.
- 10.4. A List of Contractor's key personnel (e.g., Project Manager, Project Engineers, Materials Engineers, and Foremen) assigned to the contract to be bid, with their complete qualification and experience data shall be provided. These key personnel must meet the required minimum years of experience set in the **BDS**.
- 10.5. A List of Contractor's major equipment units, which are owned, leased, and/or under purchase agreements, supported by proof of ownership, certification of availability of equipment from the equipment lessor/vendor for the duration of the project, as the case may be, must meet the minimum requirements for the contract set in the **BDS**.

11. Documents Comprising the Bid: Financial Component

- 11.1. The second bid envelope shall contain the financial documents for the Bid as specified in **Section IX. Checklist of Technical and Financial Documents**.
- 11.2. Any bid exceeding the ABC indicated in paragraph 1 of the **IB** shall not be accepted.
- 11.3. For Foreign-funded procurement, a ceiling may be applied to bid prices provided the conditions are met under Section 31.2 of the 2016 revised IRR of RA No. 9184.

12. Alternative Bids

Bidders shall submit offers that comply with the requirements of the Bidding Documents, including the basic technical design as indicated in the drawings and specifications. Unless there is a value engineering clause in the **BDS**, alternative Bids shall not be accepted.

13. Bid Prices

All bid prices for the given scope of work in the Project as awarded shall be considered as fixed prices, and therefore not subject to price escalation during contract implementation, except under extraordinary circumstances as determined by the NEDA and approved by the GPPB pursuant to the revised Guidelines for Contract Price Escalation guidelines.

14. Bid and Payment Currencies

14.1. Bid prices may be quoted in the local currency or tradeable currency accepted by the BSP at the discretion of the Bidder. However, for purposes of bid evaluation, Bids denominated in foreign currencies shall be converted to Philippine currency based on the exchange rate as published in the BSP reference rate bulletin on the day of the bid opening.

14.2. *Payment of the contract price shall be made in:*

[Select one, delete other/s]

a. Philippine Pesos.

b. *[indicate currency if procurement involves a foreign-denominated bid as allowed by the Procuring Entity, which shall be tradeable or acceptable by the BSP.]*

15. Bid Security

15.1. The Bidder shall submit a Bid Securing Declaration or any form of Bid Security in the amount indicated in the **BDS**, which shall be not less than the percentage of the ABC in accordance with the schedule in the **BDS**.

15.2. The Bid and bid security shall be valid until *[indicate date]*. Any bid not accompanied by an acceptable bid security shall be rejected by the Procuring Entity as non-responsive.

16. Sealing and Marking of Bids

Each Bidder shall submit one copy of the first and second components of its Bid.

The Procuring Entity may request additional hard copies and/or electronic copies of the Bid. However, failure of the Bidders to comply with the said request shall not be a ground for disqualification.

If the Procuring Entity allows the submission of bids through online submission to the given website or any other electronic means, the Bidder shall submit an electronic copy of its Bid, which must be digitally signed. An electronic copy that cannot be opened or is corrupted shall be considered non-responsive and, thus, automatically disqualified.

17. Deadline for Submission of Bids

The Bidders shall submit on the specified date and time and either at its physical address or through online submission as indicated in paragraph 7 of the **IB**.

18. Opening and Preliminary Examination of Bids

- 18.1. The BAC shall open the Bids in public at the time, on the date, and at the place specified in paragraph 9 of the **IB**. The Bidders' representatives who are present shall sign a register evidencing their attendance. In case videoconferencing, webcasting or other similar technologies will be used, attendance of participants shall likewise be recorded by the BAC Secretariat.

In case the Bids cannot be opened as scheduled due to justifiable reasons, the rescheduling requirements under Section 29 of the 2016 revised IRR of RA No. 9184 shall prevail.

- 18.2. The preliminary examination of Bids shall be governed by Section 30 of the 2016 revised IRR of RA No. 9184.

19. Detailed Evaluation and Comparison of Bids

- 19.1. The Procuring Entity's BAC shall immediately conduct a detailed evaluation of all Bids rated "*passed*" using non-discretionary pass/fail criteria. The BAC shall consider the conditions in the evaluation of Bids under Section 32.2 of 2016 revised IRR of RA No. 9184.
- 19.2. If the Project allows partial bids, all Bids and combinations of Bids as indicated in the **BDS** shall be received by the same deadline and opened and evaluated simultaneously so as to determine the Bid or combination of Bids offering the lowest calculated cost to the Procuring Entity. Bid Security as required by **ITB** Clause 16 shall be submitted for each contract (lot) separately.
- 19.3. In all cases, the NFCC computation pursuant to Section 23.4.2.6 of the 2016 revised IRR of RA No. 9184 must be sufficient for the total of the ABCs for all the lots participated in by the prospective Bidder.

20. Post Qualification

Within a non-extendible period of five (5) calendar days from receipt by the Bidder of the notice from the BAC that it submitted the Lowest Calculated Bid, the Bidder shall submit its latest income and business tax returns filed and paid through the BIR Electronic Filing and Payment System (eFPS), and other appropriate licenses and permits required by law and stated in the **BDS**.

21. Signing of the Contract

The documents required in Section 37.2 of the 2016 revised IRR of RA No. 9184 shall form part of the Contract. Additional Contract documents are indicated in the **BDS**.

Section III. Bid Data Sheet

Bid Data Sheet

ITB Clause																																																				
5.2	For this purpose, contracts similar to the Project refer to contracts which have the same major categories of work, which shall be: <i>Road Construction</i>																																																			
7.1	<i>Subcontracting is not allowed.</i>																																																			
10.3	<i>No further instructions.</i>																																																			
10.4	The key personnel must meet the required minimum years of experience set below: <table border="1" style="width: 100%; border-collapse: collapse;"> <thead> <tr> <th style="text-align: left;"><u>Key Personnel</u></th> <th style="text-align: center;"><u>General Experience</u></th> <th style="text-align: center;"><u>Relevant Experience</u></th> </tr> </thead> <tbody> <tr> <td>Project Manager</td> <td style="text-align: center;">one (1)</td> <td style="text-align: center;">one (1)</td> </tr> <tr> <td>Project Engineer</td> <td style="text-align: center;">one (1)</td> <td style="text-align: center;">one (1)</td> </tr> <tr> <td>Materials Engineer</td> <td style="text-align: center;">one (1)</td> <td style="text-align: center;">one (1)</td> </tr> </tbody> </table>	<u>Key Personnel</u>	<u>General Experience</u>	<u>Relevant Experience</u>	Project Manager	one (1)	one (1)	Project Engineer	one (1)	one (1)	Materials Engineer	one (1)	one (1)																																							
<u>Key Personnel</u>	<u>General Experience</u>	<u>Relevant Experience</u>																																																		
Project Manager	one (1)	one (1)																																																		
Project Engineer	one (1)	one (1)																																																		
Materials Engineer	one (1)	one (1)																																																		
10.5	The minimum major equipment requirements are the following: <table border="1" style="width: 100%; border-collapse: collapse;"> <thead> <tr> <th style="text-align: left;"><u>Equipment</u></th> <th style="text-align: center;"><u>Capacity</u></th> <th style="text-align: center;"><u>Number of Units</u></th> </tr> </thead> <tbody> <tr><td>1. Motorized Road Grader w/ Scarifier, G7 10A</td><td></td><td style="text-align: center;">1</td></tr> <tr><td>2. Vibratory Roller</td><td style="text-align: center;">10 M.T. SP 56</td><td style="text-align: center;">1</td></tr> <tr><td>3. Water Truck</td><td style="text-align: center;">1,000 gal</td><td style="text-align: center;">1</td></tr> <tr><td>4. Transit Mixer</td><td style="text-align: center;">5 cu.m.</td><td style="text-align: center;">4</td></tr> <tr><td>5. Concrete Vibrator</td><td></td><td style="text-align: center;">2</td></tr> <tr><td>6. Batching Plant</td><td style="text-align: center;">30 cu.m.</td><td style="text-align: center;">1</td></tr> <tr><td>7. Bagger Mixer</td><td style="text-align: center;">One (1) bagger</td><td style="text-align: center;">1</td></tr> <tr><td>8. Dump Truck</td><td style="text-align: center;">10 cu.m.</td><td style="text-align: center;">2</td></tr> <tr><td>9. Concrete Screeder</td><td style="text-align: center;">5.5 Hp</td><td style="text-align: center;">1</td></tr> <tr><td>10. Concrete Saw, Blade 14" dia.</td><td style="text-align: center;">7.5 Hp</td><td style="text-align: center;">1</td></tr> <tr><td>11. Bar Cutter, Single Phase, 25mm</td><td></td><td style="text-align: center;">1</td></tr> <tr><td>12. Payloader</td><td style="text-align: center;">1.50 cu.m., LX80-2c</td><td style="text-align: center;">1</td></tr> <tr><td>13. Backhoe w/ Pavement Breaker</td><td style="text-align: center;">0.80 cu.m.</td><td style="text-align: center;">1</td></tr> <tr><td>14. 4X4 Pick up Type Service Vehicle</td><td></td><td style="text-align: center;">1</td></tr> <tr><td>15. Bulldozer</td><td></td><td style="text-align: center;">2</td></tr> <tr><td>16. Backhoe (Wheel Type)</td><td></td><td style="text-align: center;">1</td></tr> </tbody> </table>	<u>Equipment</u>	<u>Capacity</u>	<u>Number of Units</u>	1. Motorized Road Grader w/ Scarifier, G7 10A		1	2. Vibratory Roller	10 M.T. SP 56	1	3. Water Truck	1,000 gal	1	4. Transit Mixer	5 cu.m.	4	5. Concrete Vibrator		2	6. Batching Plant	30 cu.m.	1	7. Bagger Mixer	One (1) bagger	1	8. Dump Truck	10 cu.m.	2	9. Concrete Screeder	5.5 Hp	1	10. Concrete Saw, Blade 14" dia.	7.5 Hp	1	11. Bar Cutter, Single Phase, 25mm		1	12. Payloader	1.50 cu.m., LX80-2c	1	13. Backhoe w/ Pavement Breaker	0.80 cu.m.	1	14. 4X4 Pick up Type Service Vehicle		1	15. Bulldozer		2	16. Backhoe (Wheel Type)		1
<u>Equipment</u>	<u>Capacity</u>	<u>Number of Units</u>																																																		
1. Motorized Road Grader w/ Scarifier, G7 10A		1																																																		
2. Vibratory Roller	10 M.T. SP 56	1																																																		
3. Water Truck	1,000 gal	1																																																		
4. Transit Mixer	5 cu.m.	4																																																		
5. Concrete Vibrator		2																																																		
6. Batching Plant	30 cu.m.	1																																																		
7. Bagger Mixer	One (1) bagger	1																																																		
8. Dump Truck	10 cu.m.	2																																																		
9. Concrete Screeder	5.5 Hp	1																																																		
10. Concrete Saw, Blade 14" dia.	7.5 Hp	1																																																		
11. Bar Cutter, Single Phase, 25mm		1																																																		
12. Payloader	1.50 cu.m., LX80-2c	1																																																		
13. Backhoe w/ Pavement Breaker	0.80 cu.m.	1																																																		
14. 4X4 Pick up Type Service Vehicle		1																																																		
15. Bulldozer		2																																																		
16. Backhoe (Wheel Type)		1																																																		
12	<i>Not Applicable</i>																																																			
15.1	The bid security shall be in the form of a Bid Securing Declaration or any of the following forms and amounts: a. The amount of not less than <u>PhP 80,000.00</u> if bid security is in cash, cashier's/manager's check, bank draft/guarantee or irrevocable letter of credit; b. The amount of not less than <u>PhP 200,000.00</u> if bid security is in Surety Bond.																																																			
19.2	<i>Not Applicable</i>																																																			
20	<i>No further instructions.</i>																																																			

21	Additional contract documents relevant to the Project that may be required by existing laws and/or the Procuring Entity, such as Affidavit of Site Inspection, Affidavit of Availability of Key Personnel and Equipment, PERT/CPM, Construction Schedule and S- curve, Manpower Utilization Schedule, Construction Methods, Equipment Utilization Schedule, Construction Safety and Health Program approved by the DOLE, and other acceptable tools of project scheduling.
----	--

Section IV. General Conditions of Contract

1. **Scope of Contract**

This Contract shall include all such items, although not specifically mentioned, that can be reasonably inferred as being required for its completion as if such items were expressly mentioned herein. All the provisions of RA No. 9184 and its 2016 revised IRR, including the Generic Procurement Manual, and associated issuances, constitute the primary source for the terms and conditions of the Contract, and thus, applicable in contract implementation. Herein clauses shall serve as the secondary source for the terms and conditions of the Contract.

This is without prejudice to Sections 74.1 and 74.2 of the 2016 revised IRR of RA No. 9184 allowing the GPPB to amend the IRR, which shall be applied to all procurement activities, the advertisement, posting, or invitation of which were issued after the effectivity of the said amendment.

2. **Sectional Completion of Works**

If sectional completion is specified in the **Special Conditions of Contract (SCC)**, references in the Conditions of Contract to the Works, the Completion Date, and the Intended Completion Date shall apply to any Section of the Works (other than references to the Completion Date and Intended Completion Date for the whole of the Works).

3. **Possession of Site**

41. The Procuring Entity shall give possession of all or parts of the Site to the Contractor based on the schedule of delivery indicated in the **SCC**, which corresponds to the execution of the Works. If the Contractor suffers delay or incurs cost from failure on the part of the Procuring Entity to give possession in accordance with the terms of this clause, the Procuring Entity's Representative shall give the Contractor a Contract Time Extension and certify such sum as fair to cover the cost incurred, which sum shall be paid by Procuring Entity.
42. If possession of a portion is not given by the above date, the Procuring Entity will be deemed to have delayed the start of the relevant activities. The resulting adjustments in contract time to address such delay may be addressed through contract extension provided under Annex "E" of the 2016 revised IRR of RA No. 9184.

4. **The Contractor's Obligations**

The Contractor shall employ the key personnel named in the Schedule of Key Personnel indicating their designation, in accordance with **ITB** Clause 10.3 and specified in the **BDS**, to carry out the supervision of the Works.

The Procuring Entity will approve any proposed replacement of key personnel only if their relevant qualifications and abilities are equal to or better than those of the personnel listed in the Schedule.

5. Performance Security

- 5.1. Within ten (10) calendar days from receipt of the Notice of Award from the Procuring Entity but in no case later than the signing of the contract by both parties, the successful Bidder shall furnish the performance security in any of the forms prescribed in Section 39 of the 2016 revised IRR.
- 5.2. The Contractor, by entering into the Contract with the Procuring Entity, acknowledges the right of the Procuring Entity to institute action pursuant to RA No. 3688 against any subcontractor be they an individual, firm, partnership, corporation, or association supplying the Contractor with labor, materials and/or equipment for the performance of this Contract.

6. Site Investigation Reports

The Contractor, in preparing the Bid, shall rely on any Site Investigation Reports referred to in the SCC supplemented by any information obtained by the Contractor.

7. Warranty

- 7.1. In case the Contractor fails to undertake the repair works under Section 62.2.2 of the 2016 revised IRR, the Procuring Entity shall forfeit its performance security, subject its property(ies) to attachment or garnishment proceedings, and perpetually disqualify it from participating in any public bidding. All payables of the GOP in his favor shall be offset to recover the costs.
- 7.2. The warranty against Structural Defects/Failures, except that occasioned-on force majeure, shall cover the period from the date of issuance of the Certificate of Final Acceptance by the Procuring Entity. Specific duration of the warranty is found in the SCC.

8. Liability of the Contractor

Subject to additional provisions, if any, set forth in the SCC, the Contractor's liability under this Contract shall be as provided by the laws of the Republic of the Philippines.

If the Contractor is a joint venture, all partners to the joint venture shall be jointly and severally liable to the Procuring Entity.

9. Termination for Other Causes

Contract termination shall be initiated in case it is determined *prima facie* by the Procuring Entity that the Contractor has engaged, before, or during the implementation of the contract, in unlawful deeds and behaviors relative to contract acquisition and implementation, such as, but not limited to corrupt, fraudulent, collusive, coercive, and obstructive practices as stated in ITB Clause 4.

10. Dayworks

Subject to the guidelines on Variation Order in Annex “E” of the 2016 revised IRR of RA No. 9184, and if applicable as indicated in the **SCC**, the Dayworks rates in the Contractor’s Bid shall be used for small additional amounts of work only when the Procuring Entity’s Representative has given written instructions in advance for additional work to be paid for in that way.

11. Program of Work

11.1. The Contractor shall submit to the Procuring Entity’s Representative for approval the said Program of Work showing the general methods, arrangements, order, and timing for all the activities in the Works. The submissions of the Program of Work are indicated in the **SCC**.

11.2. The Contractor shall submit to the Procuring Entity’s Representative for approval an updated Program of Work at intervals no longer than the period stated in the **SCC**. If the Contractor does not submit an updated Program of Work within this period, the Procuring Entity’s Representative may withhold the amount stated in the **SCC** from the next payment certificate and continue to withhold this amount until the next payment after the date on which the overdue Program of Work has been submitted.

12. Instructions, Inspections and Audits

The Contractor shall permit the GOP or the Procuring Entity to inspect the Contractor’s accounts and records relating to the performance of the Contractor and to have them audited by auditors of the GOP or the Procuring Entity, as may be required.

13. Advance Payment

The Procuring Entity shall, upon a written request of the Contractor which shall be submitted as a Contract document, make an advance payment to the Contractor in an amount not exceeding fifteen percent (15%) of the total contract price, to be made in lump sum, or at the most two installments according to a schedule specified in the **SCC**, subject to the requirements in Annex “E” of the 2016 revised IRR of RA No. 9184.

14. Progress Payments

The Contractor may submit a request for payment for Work accomplished. Such requests for payment shall be verified and certified by the Procuring Entity’s Representative/Project Engineer. Except as otherwise stipulated in the **SCC**, materials and equipment delivered on the site but not completely put in place shall not be included for payment.

15. Operating and Maintenance Manuals

15.1. If required, the Contractor will provide “as built” Drawings and/or operating and maintenance manuals as specified in the **SCC**.

- 15.2. If the Contractor does not provide the Drawings and/or manuals by the dates stated above, or they do not receive the Procuring Entity's Representative's approval, the Procuring Entity's Representative may withhold the amount stated in the SCC from payments due to the Contractor.

Section V. Special Conditions of Contract

Special Conditions of Contract

GCC Clause	
2	<i>Not Applicable</i>
4.1	<i>upon receipt of the Notice to Proceed</i>
6	The site investigation reports are: <i>Present condition of the actual project site</i>
7.2	<i>For semi-permanent structures, such as buildings of types 1, 2, and 3 as classified under the National Building Code of the Philippines, concrete/asphalt roads, concrete river control, drainage, irrigation lined canals, river landing, deep wells, rock causeway, pedestrian overpass, and other similar semi-permanent structures: Five (5) years.</i>
10	Dayworks are applicable at the rate shown in the Contractor's original Bid.
11.1	The Contractor shall submit the Program of Work to the Procuring Entity's Representative within <i>5 working days</i> of delivery of the Notice of Award.
11.2	The period between Program of Work updates is thirty (30) days. The amount to be withheld for late submission of an updated Program of Work is 1% of progress billing.
13	The amount of the advance payment is <i>15% of the total contract price.</i>
14	<i>Materials and equipment delivered on the site but not completely put in place shall NOT be included for payment.</i>
15.1	The date by which "as built" drawings are required is 15-30 days upon completion date.
15.2	The amount to be withheld for failing to produce "as built" drawings by the date required is 1% of the final contract amount in Philippine pesos.

Section VI. Specifications

ITEM 100 – CLEARING AND GRUBBING

100.1 Description

This item shall consist of clearing, grubbing, removing and disposing all vegetation and debris as designated in the Contract, except those objects that are designated to remain in place or are to be removed in consonance with other provisions of this Specification. The work shall also include the preservation from injury or defacement of all objects designated to remain.

100.2 Construction Requirements

100.2.1 General

The Engineer will establish the limits of work and designate all trees, shrubs, plants and other things to remain. The Contractor shall preserve all objects designated to remain.

Paint required for cut or scarred surface of trees or shrubs selected for retention shall be an approved asphaltum base paint prepared especially for tree surgery.

Clearing shall extend one (1) meter beyond the toe of the fill slopes or beyond rounding of cut slopes as the case maybe for the entire length of the project unless otherwise shown on the plans or as directed by the Engineer and provided it is within the right of way limits of the project, with the exception of trees under the jurisdiction of the Forest Management Bureau (FMB).

100.2.2 Clearing and Grubbing

All surface objects and all trees, stumps, roots and other protruding obstructions, not designated to remain, shall be cleared and/or grubbed, including mowing as required, except as provided below:

(1) Removal of undisturbed stumps and roots and nonperishable solid objects with a minimum depth of one (1) meter below subgrade or slope of embankment will not be required.

(2) In areas outside of the grading limits of cut and embankment areas, stumps and nonperishable solid objects shall be cut off not more than 150 mm (6 inches) above the ground line or low water level.

(3) In areas to be rounded at the top of cut slopes, stumps shall be cut off flush with or below the surface of the final slope line.

(4) Grubbing of pits, channel changes and ditches will be required only to the depth necessitated by the proposed excavation within such areas.

(5) In areas covered by cogon/talahib, wild grass and other vegetations, top soil shall be cut to a maximum depth of 150 mm below the original ground surface or as designated by the Engineer, and disposed outside the clearing and grubbing limits as indicated in the typical roadway section.

Except in areas to be excavated, stump holes and other holes from which obstructions are removed shall be backfilled with suitable material and compacted to the required density.

If perishable material is burned, it shall be burned under the constant care of component watchmen at such times and in such a manner that the surrounding vegetation, other adjacent property, or anything designated to remain on the right of way will not be jeopardized. If permitted, burning shall be done in accordance with applicable laws, ordinances, and regulation.

The Contractor shall use high intensity burning procedures, (i.e., incinerators, high stacking or pit and ditch burning with forced air supplements) that produce intense burning with little or no visible smoke emission during the burning process. At the conclusion of each burning session, the fire shall be completely extinguished so that no smoldering debris remains.

In the event that the Contractor is directed by the Engineer not to start burning operations or to suspend such operations because of hazardous weather conditions, material to be burned which interferes with subsequent construction operations shall be moved by the Contractor to temporary locations clear of construction operations and later, if directed by the Engineer, shall be placed on a designated spot and burned.

Materials and debris which cannot be burned and perishable materials may be disposed off by methods and at locations approved by the Engineer, on or off the project. If disposal is by burying, the debris shall be placed in layers with the material so disturbed to avoid nesting. Each layer shall be covered or mixed with earth material by the land-fill method to fill all voids. The top layer of material buried shall be covered with at least 300 mm (12 inches) of earth or other approved material and shall be graded, shaped and compacted to present a pleasing appearance. If the disposal location is off the project, the Contractor shall make all necessary arrangements with property owners in writing for obtaining suitable disposal locations which are outside the limits of view from the project. The cost involved shall be included in the unit bid price. A copy of such agreement shall be furnished to the Engineer. The disposal areas shall be seeded, fertilized and mulched at the Contractor's expense.

Woody material may be disposed off by chipping. The wood chips may be used for mulch, slope erosion control or may be uniformly spread over selected areas as directed by the Engineer. Wood chips used as mulch for slope erosion control shall have a maximum thickness of 12 mm (1/2 inch) and faces not exceeding 3900 mm² (6 square inches) on any individual surface area. Wood chips not designated for use under other sections shall be spread over the designated areas in layers not to exceed 75 mm (3 inches) loose thickness. Diseased trees shall be buried or disposed off as directed by the Engineer.

All merchantable timber in the clearing area which has not been removed from the right of way prior to the beginning of construction, shall become the property of the Contractor, unless otherwise provided.

Low hanging branches and unsound or unsightly branches on trees or shrubs designated to remain shall be trimmed as directed. Branches of trees extending over the roadbed shall be trimmed to give a clear height of 6 m (20 feet) above the roadbed surface. All trimming shall be done by skilled workmen and in accordance with good tree surgery practices.

Timber cut inside the area staked for clearing shall be felled within the area to be cleared.

100.2.3 Individual Removal of Trees or Stumps

Individual trees or stumps designated by the Engineer for removal and located in areas other than those established for clearing and grubbing and roadside cleanup shall be removed and disposed off as specified under Subsection 100.2.2 except trees removed shall be cut as nearly flush with the ground as practicable without removing stumps.

100.3 Method of Measurement

Measurement will be by one or more of the following alternate methods:

Area Basis. The work to be paid for shall be the number of hectares and fractions thereof acceptably cleared and grubbed within the limits indicated on the Plans or as may be adjusted in field staking by the Engineer. Areas not within the clearing and grubbing limits shown on the Plans or not staked for clearing and grubbing will not be measured for payment.

2. Lump-Sum Basis. When the Bill of Quantities contains a Clearing and Grubbing lump-sum item, no measurement of area will be made for such item.

3. Individual Unit Basis (Selective Clearing). The diameter of trees will be measured at a height of 1.4 m (54 inches) above the ground. Trees less than 150 mm (6 inches) in diameter will not be measured for payment.

When Bill of Quantities indicates measurement of trees by individual unit basis, the units will be designated and measured in accordance with the following schedule of sizes:

Diameter at height of 1.4 m	Pay Item Designation
Over 150 mm to 900 mm	Small
Over 900 mm	Large

100.4 Basis of Payment

The accepted quantities, measured as prescribed in Section 100.3, shall be paid for at the Contract unit price for each of the Pay Items listed below that is included in the Bill of Quantities, which price and payment shall be full compensation for furnishing all labor, equipment, tools and incidentals necessary to complete the work prescribed in this Item.

Payment will be made under: Pay Item Number	Description	Unit of Measurement
100 (1)	Clearing and Grubbing	Hectare
100 (2)	Clearing and Grubbing	Lump Sum
100 (3)	Individual Removal of Trees, Small	Each
100 (4)	Individual removal of	Each

ITEM 101 – REMOVAL OF STRUCTURES AND OBSTRUCTIONS

101.1 Description

This Item shall consist of the removal wholly or in part, and satisfactory disposal of all buildings, fences, structures, old pavements, abandoned pipe lines, and any other obstructions which are not designated or permitted to remain, except for the obstructions to be removed and disposed off under other items in the Contract. It shall also include the salvaging of designated materials and backfilling the resulting trenches, holes, and pits.

101.2 Construction Requirements

101.2.1 General

The Contractor shall perform the work described above, within and adjacent to the roadway, on Government land or easement, as shown on the Plans or as directed by the Engineer. All designated salvable material shall be removed, without unnecessary damage, in sections or pieces which may be readily transported, and shall be stored by the Contractor at specified places on the project or as otherwise shown in the Special Provisions. Perishable material shall be handled as designated in Subsection 100.2.2 Nonperishable material may be disposed off outside the limits of view from the project with written permission of the property owner on whose property the material is placed. Copies of all agreements with property owners are to be furnished to the Engineer. Basements or cavities left by the structure removal shall be filled with acceptable material to the level of the surrounding ground and, if within the prism of construction, shall be compacted to the required density.

101.2.2 Removal of Existing Bridges, Culverts, and other Drainage Structures

All existing bridges, culverts and other drainage structures in use by traffic shall not be removed until satisfactory arrangements have been made to accommodate traffic. The removal of existing culverts within embankment areas will be required only as necessary for the installation of new structures. Abandoned culverts shall be broken down, crushed and sealed or plugged. All retrieved culvert for future use as determined by the Engineer shall be carefully removed and all precautions shall be employed to avoid breakage or structural damage to any of its part. All sections of structures removed which are not designated for stockpiling or re-laying shall become the property of the Government and be removed from the project or disposed off in a manner approved by the Engineer.

Unless otherwise directed, the substructures of existing structures shall be removed down to the natural stream bottom and those parts outside of the stream shall be removed down to at least 300 mm (12 inches) below natural ground surface. Where such portions of existing structures lie wholly or in part within the limits for a new structure, they shall be removed as necessary to accommodate the construction of the proposed structure.

Steel bridges and wood bridges when specified to be salvaged shall be carefully dismantled without damaged. Steel members shall be match marked unless such match marking is waived by the Engineer. All salvaged material shall be stored as specified in Subsection 101.2.1. Structures designated to become the property of the Contractor shall be removed from the right-of-way.

Blasting or other operations necessary for the removal of an existing structure or obstruction, which may damage new construction, shall be completed prior to placing the new work, unless otherwise provided in the Special Provisions.

101.2.3 Removal of Pipes Other than Pipe Culverts

Unless otherwise provided, all pipes shall be carefully removed and every precaution taken to avoid breakage or damaged. Pipes to be relaid shall be removed and stored when necessary so that there will be no loss of damage before re-laying. The Contractor shall replace sections lost from storage or damage by negligence, at his own expense.

101.2.4 Removal of Existing Pavement, Sidewalks, Curbs, etc.

All concrete pavement, base course, sidewalks, curbs, gutters, etc., designated for removal, shall be:

(1) Broken into pieces and used for riprap on the project, or

(2) Broken into pieces, the size of which shall not exceed 300 mm (12 inches) in any dimension and stockpiled at designated locations on the project for use by the Government, or

(3) Otherwise demolished and disposed off as directed by the Engineer. When specified, ballast, gravel, bituminous materials or other surfacing or pavement materials shall be removed and stockpiled as required in Subsection 101.2.1, otherwise such materials shall be disposed off as directed.

There will be no separate payment for excavating for removal of structures and obstructions or for backfilling and compacting the remaining cavity.

101.3 Method of Measurement

When the Contract stipulates that payment will be made for removal of obstructions on lump-sum basis, the pay item will include all structures and obstructions encountered within the roadway. Where the contract stipulates that payment will be made for the removal of specific items on a unit basis, measurement will be made by the unit stipulated in the Contract.

Whenever the Bill of Quantities does not contain an item for any aforementioned removals, the work will not be paid for directly, but will be considered as a subsidiary obligation of the Contractor under other Contract Items.

101.4 Basis of Payment

The accepted quantities, measured as prescribed in Section 101.3, shall be paid for at the Contract unit price or lump sum price bid for each of the Pay Items listed below that is included in the Bill of Quantities which price and payment shall be full compensation for removing and disposing of obstructions, including materials, labor, equipments, tools and incidentals necessary to complete the work prescribed in this Item. The price shall also include backfilling, salvage of materials removed, their custody, preservation, storage on the right-of-way and disposal as provided herein.

Payment will be made under:

Pay Item Number	Description	Unit of Measurement
101 (1)	Removal of Structures and Obstruction	Lump Sum
101 (2)	Removal of	Each
101 (3)	Removal of	Square Meter
101 (4)	Removal of	Linear Meter

ITEM 102- EXCAVATION

102.1 Description This Item shall consist of roadway and drainage and borrow excavation and the disposal of material in accordance with this Specification and in conformity with the lines, grades and dimensions shown on the Plans or established by the Engineer.

102.1.1 Roadway Excavation Roadway excavation will include excavation and grading for roadways,

parking areas, intersections, approaches, slope rounding, benching, waterways and ditches; removal of unsuitable material from the road bed and beneath embankment areas; and excavating selected material found in the roadway as ordered by the Engineer for specific use in the improvement. Roadway excavation will be classified as “unclassified excavation”, “rock excavation”, “common excavation”, or “muck excavation” as indicated in the Bill of Quantities and hereinafter described.

(1) Unclassified Excavation. Unclassified excavation shall consist of the excavation and disposal of all materials regardless of its nature, not classified and included in the Bill of Quantities under other pay items.

(2) Rock Excavation. Rock excavation shall consist of igneous, sedimentary and metamorphic rock which cannot be excavated without blasting or the use of ripper, and all boulders or other detached stones each having a volume of 1 cubic meter or meter as determined by physical measurements or visually by the Engineer.

(3) Common Excavation. Common excavations shall consists of all excavation not included in the Bill of Quantities under” rock excavation” or other pay items.

(4) Muck Excavation. Muck excavation shall consist of the removal and disposal of deposits of saturated or unsaturated mixtures of soils and organic matter not suitable for foundation material regardless of moisture content.

102.1.2 Borrow Excavation Borrow excavation shall consists of the excavation and utilization of approved material required for the construction of embankments or for other portion of the work, and shall be obtained from approved sources, in accordance with Clause 61 and the following:

(1) Borrow, Case 1 Borrow Case 1 will consist of material obtained from sources designated on the Plans or in the Special Provisions.

(2) Borrow, Case 2 Borrow Case 2 will consist of material obtained from sources provided by the Contractor. The material shall meet the quality requirements determined by the Engineer unless otherwise provided in the Contractor. The material shall meet the quality determined by the Engineer unless otherwise provided in the Contract.

102.2 Construction Requirements

102.2.1 General When there is evidence of discrepancies on the actual elevations and that shown on the Plans a pre-construction survey referred to the datum plane used in the approved Plan shall be undertaken by the Contractor under the control of the Engineer to serve as basis for the computation of the actual volume of the excavated materials. All excavations shall be finished to reasonably smooth and uniform surfaces. No materials shall be wasted without authority of the Engineer. Excavation operations shall be conducted so that material outside of the limits of slopes will not be disturbed. Prior to excavation, all necessary clearing and grubbing in that area shall have been performed in accordance with Item 100, Clearing and Grubbing.

102.2.2 Conservation of Topsoil Where provided for on the Plans or in the Special Provisions,

suitable topsoil encountered in excavation and on areas where embankment is to be placed shall be removed to such extent and to such depth as the Engineer may direct. The removed topsoil shall be transported and deposited in storage piles at locations approved by the Engineer. The topsoil shall be completely removed to the required depth from any designated area prior to the beginning of regular excavation or embankment work in the area and shall be kept separate from other excavated materials for later use.

102.2.3 Utilization of Excavated Materials All suitable material removed from the excavation shall be used in the formation of the embankment, subgrade, shoulders, slopes, bedding, and backfill for structures, and for other purposes shown on the Plans or as directed. The Engineer will designate as unsuitable those soils that cannot be properly compacted in embankments. All unsuitable material shall be disposed off as shown on the Plans or as directed without delay to the Contractor. Only approved materials shall be used in the construction of embankments and backfills. All excess materials, including rock and boulders that cannot be used in embankments shall be disposed off as directed.

Material encountered in the excavation and determined by the Engineer as suitable for topping, road finishing, slope protection, or other purposes shall be conserved and utilized as directed by the Engineer. Borrow material shall not be placed until after the readily accessible roadway excavation has been placed in the fill, unless otherwise permitted or directed by the Engineer. If the Contractor places more borrow than is required and thereby causes a waste of excavation, the amount if such waste will be deducted from the borrow volume.

102.2.4 Prewatering

Excavation areas and borrow pits may be prewatered before excavating the material. When prewatering is used, the areas to be excavated shall be moistened to the full depth, from the surface to the bottom of the excavation. The water shall be controlled so that the excavated material will contain the proper moisture to permit compaction to the specified density with the use of standard compacting equipment. Prewatering shall be supplemented where necessary, by truck watering units, to ensure that the embankment material contains the proper moisture at the time of compaction. The Contractor shall provide drilling equipment capable of suitably checking the moisture penetration to the full depth of the excavation.

102.2.5 Presplitting

Unless otherwise provided in the Contract, rock excavation which requires drilling and shooting shall be presplit.

Presplitting to obtain faces in the rock and shale formations shall be performed by: (1) drilling holes at uniform intervals along the slope lines, (2) loading and stemming the holes with appropriate explosives and stemming material, and (3) detonating the holes simultaneously.

Prior to starting drilling operations for presplitting, the Contractor shall furnish the Engineer a plan outlining the position of all drill holes, depth of drilling, type of explosives to be used, loading pattern and sequence of firing. The drilling and blasting plan is for record purposes only and will not absolve the Contractor of his responsibility for using proper drilling and blasting procedures. Controlled

blasting shall begin with a short test section shall be presplit, production drilled and blasted and sufficient material excavated whereby the Engineer can determine if the Contractor's method are satisfactory. The Engineer may order discontinuance of the presplitting when he determines that the materials encountered have become unsuitable for being presplit.

The holes shall be charged with explosives of the size, kind strength, and at the spacing suitable for the formations being presplit, and with stemming material which passes a 9.5 mm (3/8 inch) standard sieve and which has the qualities for proper confinement of the explosives.

The finished presplit slope shall be reasonably uniform and free of loose rock. Variance from the true plane of the excavated backslope shall not exceed 300 mm (12 inches); however, localized irregularities or surface variations that do not constitute a safety hazard or an impairment to drainage courses or facilities will be permitted.

A maximum offset of 600 mm (24 inches) will be permitted for a construction working bench at the bottom of each lift for use in drilling the next lower presplitting pattern.

102.2.6 Excavation of Ditches, Gutters, etc.

All materials excavated from side ditches and gutters, channel changes, irrigation ditches, and such other ditches as may be designated on the Plans or staked by the Engineer, shall be utilized as provided in Subsection 102.2.3.

Ditches shall conform to the slope, grade, and shape of the required cross-section, with no projections of roots, stumps, rock, or similar matter. The Contractor shall maintain and keep open and free from leaves, sticks, and other debris all ditches dug by him until final acceptance of the work.

Furrow ditches shall be formed by plowing a continuous furrow along the line staked by the Engineer. Methods other than plowing may be used if acceptable to the Engineer. The ditches shall be cleaned out by hand shovel work, by ditcher, or by some other suitable method, throwing all loose materials on the downhill side so that the bottom of the finished ditch shall be approximately 450 mm (18 inches) below the crest of the loose material piled on the downhill side. Hand finish will not be required, but the flow lines shall be in satisfactory shape to provide drainage without overflow.

102.2.7 Excavation of Roadbed Level

Rock shall be excavated to a depth of 150 mm (6 inches) below subgrade within the limits of the roadbed, and the excavation backfilled with material designated on the Plans or approved by the Engineer and compacted to the required density.

When excavation methods employed by the Contractor leave undrained pockets in the rock surface, the Contractor shall at his own expense, properly drain such depressions or when permitted by the Engineer fill the depressions with approved impermeable material.

Material below subgrade, other than solid rock shall be thoroughly scarified to a depth of 150 (6 inches) and the moisture content increased or reduced, as necessary, to bring the material throughout

this 150 mm layer to the moisture content suitable for maximum compaction. This layer shall then be compacted in accordance with Subsection 104.3.3.

102.2.8 Borrow Areas

The Contractor shall notify the Engineer sufficiently in advance of opening any borrow areas so that cross-section elevations and measurements of the ground surface after stripping may be taken, and the borrow material can be tested before being used. Sufficient time for testing the borrow material shall be allowed.

All borrow areas shall be bladed and left in such shape as to permit accurate measurements after excavation has been completed. The Contractor shall not excavated beyond the dimensions and elevations established, and no material shall be removed prior to the staking out and cross-sectioning of the site. The finished borrow areas shall be approximately true to line and grade established and specified and shall be finished, as prescribed in Clause 61, Standard Specifications for Public Works and Highways, Volume 1. When necessary to remove fencing, the fencing shall be replaced in at least as good condition as it was original. The Contractor shall be responsible for the confinement of livestock when a portion of the fence is removed.

102.2.9 Removal of Unsuitable Material

Add the following paragraph:

When any material, including excess unsuitable material from excavations, is to be disposed of outside the right-of-way the Contractor shall first obtain a written permit from the property owner of the proposed disposal site. He shall then submit to the Engineer the said permit or a certified copy thereof together with a written release by the property owner absolving the government from any and all responsibility in connection with the disposal of materials on his property. No disposal of any material shall be done on the disposal site before a permission is granted by the Engineer. The disposal of material at the site as provided above shall be made in a neat and uniform manner and to the satisfaction of the Engineer.

102.3 Methods of Measurement

The cost of excavation of material which is incorporated in the Works or in other areas of fill shall be deemed to be included in the Items of Work where the material is used.

Measurement of Unsuitable or Surplus Material shall be the net volume in its original position.

For measurement purposes, surplus suitable material shall be calculated as the difference between the net volume of suitable material required to be used in embankment corrected by applying a shrinkage factor or a swell factor in case of rock excavation, determined by laboratory tests to get its original volume measurement, and the net volume of suitable material from excavation in the original position. Separate pay items shall be provided for surplus common, unclassified and rock material.

The Contractor shall be deemed to have included in the contract unit prices all costs of obtaining land

for the disposal of unsuitable or surplus material.

102.4 Basis of Payment

The paragraph under this Section is amended as follows: The accepted quantities, measured as prescribed in Section 102.3 shall be paid for at the contract unit price for each of the Pay Items listed below that are included in the Bill of Quantities, which price and payment shall be full compensation for the removal and disposal of excavated materials including labor, equipment, tools and incidentals necessary to complete the work prescribed in this Item, inclusive of haul and any “overhaul” described under Item 107.

Payment will be made under:

Payment Item	Description	Unit of Measurement
102 (1)	Unsuitable Excavation	cu.m
102 (2)	Surplus Common Excavation	cu.m.

ITEM 103 - STRUCTURE EXCAVATION

103.1 Description

This Item shall consist of the necessary excavation for foundation of bridge, culverts, underdrains, and other structures not otherwise provided for in the Specifications. Except as otherwise provided for pipe culverts, the backfilling of completed structures and the disposal of all excavated surplus materials, shall be in accordance with these Specifications and in reasonably close conformity with the Plans or as established by the Engineer.

This Item shall include necessary diverting of live streams, bailing, pumping, draining, sheeting, bracing, and necessary construction of cribs and cofferdams, and furnishing the materials therefore, and the subsequent removal of cribs and cofferdams and the placing of all necessary backfill.

It shall also include the furnishing and placing of approved foundation fill material to replace unsuitable material encountered below the foundation elevation of structures.

No allowances will be made for classification of different types of material encountered.

103.2 Construction Requirements

103.2.1 Clearing and Grubbing

103.2.2 Excavation

General, all structures. The Contractor shall notify the Engineer sufficiently in advance of the beginning of any excavation so that cross-sectional elevations and measurements may be taken on

the undisturbed ground. The natural ground adjacent to the structure shall not be disturbed without permission of the Engineer.

Trenches or foundation pits for structures or structure footing shall be excavated to the lines and grades or elevations shown on the Plans or as staked by the Engineer. They shall be of sufficient size to permit the placing of structures or structure footing of the full width and length shown. The elevations of the bottoms of footings, as shown on the Plans, shall be considered as approximate only and the Engineer may order; in writing, such changes in dimensions or elevations of footings as may be deemed necessary, to secure a satisfactory foundation.

Boulders, logs and other objectionable materials encountered in excavation shall be removed.

After each excavation is completed, the Contractor shall notify the Engineer to that effect and no footing, bedding material or pipe culvert shall be placed until the Engineer has approved the depth of excavation and the character of the foundation material.

Structures other than pipe culverts. All rocks or other hard foundation materials shall be cleaned all loose materials, and cut to a firm surface, either level, stepped, or serrated as directed by the Engineer. All seams or crevices shall be cleaned and grouted. All loose and disintegrated rocks and thin strata shall be removed. When the footing is to rest on material other than rock, excavation to final grade shall not be made until just before the footing is to be placed. When the foundation material is soft or mucky or otherwise unsuitable, as determined by the Engineer, the Contractor shall remove the unsuitable material and backfill with approved granular material. This foundation fill shall be placed and compacted in 150 mm (6 inches) layers up to the foundation elevation.

When foundation piles are used, the excavation of each pit shall be completed before the piles are driven and any placing of foundation fill shall be done after the piles are driven. After the driving is completed, all loose and displaced materials shall be removed, leaving a smooth, solid bed to receive the footing.

Pipe Culverts. The width of the pipe trench shall be sufficient to permit satisfactory jointing of the pipe and thorough tamping of the bedding material under and around the pipe.

Where rock, harden, or other unyielding material is encountered, it shall be removed below the foundation grade for a depth of at least 300 mm or 4 mm for each 100 mm of fill over the top of pipe, whichever is greater, but not exceed three-quarters of the vertical inside diameter of the pipe. The width of the excavation shall be at least 300 mm (12 inches) greater than the horizontal outside diameter of the pipe. The excavation below grade shall be backfilled with selected fine compressible material, such as silty clay or loam, and lightly compacted in layers not over 150 mm (6 inches) in uncompacted depth to form a uniform but yielding foundation.

Where a firm foundation is not encountered at the grade established, due to soft, spongy, or other unstable soil such as unstable soil under the pipe and for a width of at least one diameter on each side of the pipe shall be removed to the depth directed by the Engineer and replaced with approved granular foundation fill material properly compacted to provide adequate support for the pipe, unless other special construction methods are called for on the Plans.

The foundation surface shall provide a firm foundation of uniform density throughout the length of the culvert and, if directed by the Engineer, shall be cambered in the direction parallel to the pipe centerline.

Where pipe culverts are to be placed in trenches excavated in embankments, the excavation of each trench shall be performed after the embankment has been constructed to a plane parallel to the proposed profile grade and to such height above the bottom of the pipe as shown on the Plans or directed by the Engineer.

103.2.3 Utilization of Excavated Material

All excavated material, so far as suitable, shall be utilized as backfill or embankment. The surplus materials shall be disposed off in such manner as not to obstruct the stream or otherwise impair the efficiency or appearance of the structure. No excavated materials shall be deposited at any times so as to endanger the partly finished structure.

103.2.4 Cofferdams

uitable and practically watertight cofferdams shall be used wherever water-bearing strata are encountered above the elevation of the bottom of the excavation. If requested, the Contractor shall submit drawings showing his proposed method of cofferdam construction, as directed by the Engineer.

Cofferdams or cribs for foundation construction shall in general, be carried well below the bottoms of the footings and shall be well braced and as nearly watertight as practicable. In general, the interior dimensions of cofferdams shall be such as to give sufficient clearance for the construction of forms and the inspection of their exteriors, and to permit pumping outside of the forms. Cofferdams or cribs which are tilted or moved laterally during the process of sinking shall be righted or enlarged so as to provide the necessary clearance.

When conditions are encountered which, as determined by the Engineer, render it impracticable to dewater the foundation before placing the footing, the Engineer may require the construction of a concrete for such a thickness as to resist any possible uplift. The concrete for such seal shall be placed as shown on the Plans or directed by the Engineer. The foundation shall then be dewatered and the footing placed. When weighted cribs are employed and the mass is utilized to overcome partially the hydrostatic pressure acting against the bottom of the foundation seal, special anchorage such as dowels or keys shall be provided to transfer the entire mass of the crib to the foundation seal. When a foundation seal is placed under water. The cofferdams shall be vented or ported at low water level as directed.

Cofferdams shall be constructed so as to protect green concrete against damage from sudden rising of the stream and to prevent damage to the foundation by erosion. No timber or bracing shall be left in cofferdams or cribs in such a way as to extend into substructure masonry, without written permission from the Engineer.

Any pumping that may be permitted from the interior of any foundation enclosure shall be done in such a manner as to preclude the possibility of any portion of the concrete material being carried

away. Any pumping required during the placing of concrete, or for a period of at least 24 hours thereafter, shall be done from a suitable sump located outside the concrete forms. Pumping to dewater a sealed cofferdam shall not commence forms. Pumping to dewater a sealed cofferdam shall not commence until the seal has set sufficiently to withstand the hydrostatic pressure.

Unless otherwise provided, cofferdams or cribs, with all sheeting and bracing involved therewith, shall be removed by the Contractor after the completion of the substructure. Removal shall be effected in such manner as not to disturb or mar finished masonry.

103.2.5 Preservation of Channel

Unless otherwise permitted, no excavation shall be made outside of caissons, cribs, cofferdams, or sheet piling, and the natural stream bed adjacent to structure shall not be disturbed without permission from the Engineer. If any excavation or dredging is made at the side of the structure before caissons, cribs, or cofferdams are sunk in place, the Contractor shall, after the foundation base is in place, backfill all such excavations to the original ground surface or stream bed with material satisfactory to the Engineer.

103.2.6 Backfill and Embankment for Structures Other than Pipe Culverts

Excavated areas around structures shall be backfilled with free draining granular material approved by the Engineer and placed in horizontal layers not over 150 mm (6inches) in thickness, to the level of the original ground surface. Each layer shall be moistened or dried as required and thoroughly compacted with mechanical tampers.

In placing backfills or embankment, the material shall be placed simultaneously in so far as possible to approximately the same elevation on both sides of an abutment, pier or wall. If conditions require placing backfill or embankment appreciably higher on one side shall not be placed until masonry has been place for 14 days, or until tests made by the laboratory under the supervision of the Engineer establishes that the masonry has attained sufficient strength to withstand any pressure created by the methods used and materials placed without damage or strain beyond a safe factor.

Backfill or embankment shall not be placed behind the walls of concrete culverts or abutments or rigid frame structures until the top slab is placed and cured. Backfill and embankment behind abutments held at the top by the superstructure, and behind the sidewalls of culverts, shall be carried up simultaneously behind opposite abutments or sidewalls.

All embankments adjacent to structures shall be constructed in horizontal layers and compacted as prescribed in Subsection 104.3.3 except that mechanical tampers may be used for the required compaction. Special care shall be taken to prevent any wedging action against the structure and slopes bounding or within the areas to be filled shall be benched or serrated to prevent wedge action. The placing of embankment and the benching of slopes shall continue in such a manner that at all times there will be horizontal berm of thoroughly compacted material for a distance at least equal to the height of the abutment or wall to the backfilled against except insofar as undisturbed material obtrudes upon the area.

Broken rock or coarse sand and gravel shall be provided for a drainage filter at weepholes as shown

on the Plans.

103.2.7 Bedding, Backfill, and Embankment for Pipe Culverts

Bedding, Backfill and Embankment for pipe culverts shall be done in accordance with Item 500, Pipe Culverts and Storm Drains.

103.3 Method of Measurement

103.3.1 Structure Excavation

The volume of excavation to be paid for will be the number of cubic metres measured in original position of material acceptably excavated on conformity with the Plans as directed by the Engineer, but in no case, except as noted, will any of the following volumes be included in the measurement for payment.

The volume outside of vertical planes 450 mm (18inches) outside of and parallel to the neat lines of footings and the inside walls of pipe and pipe-arch culverts at their widest horizontal dimensions. The volume of excavation for culvert and sections outside the vertical plane for culverts stipulated in (1) above.

The volume outside of neat lines of underdrains as shown on the Plans, and outside the limits of foundation fill as ordered by the Engineer.

The volume included within the staked limits of the roadway excavation, contiguous channel changes, ditches, etc., for which payment is otherwise provided in the Specification,

Volume of water or other liquid resulting from construction operations and which can be pumped or drained away.

The volume of any excavation performed prior to the taking of elevations and measurements of the undisturbed ground.

The volume of any material rehandled ,except that where the Plans indicate or the Engineer directs the excavation after embankment has been placed and except that when installation of pipe culverts by the imperfect trench method specified in Item 500 is required, the volume of material re-excavated as directed will be included.

The volume of excavation for footings ordered at a depth more than 1.5m (60inches) below the lowest elevation for such footings shown on the original Contract Plans, unless the Bill of Quantities contains a pay item for excavation ordered below the elevations shown on the Plans for individual footings.

103.3.3 Free Draining Backfill

The Contractor shall supply, place and compact free-draining backfill to the lines, grades and

dimensions and in the locations shown on the Drawings or instructed.

Free draining backfill shall be obtained from approved sources and shall be well graded with a maximum dimension of 150 mm, and not more than 5% smaller than 0.075 mm. Freed draining backfill placed within 1 m of concrete structures shall not contain rocks larger than 75 mm in maximum dimension and shall be placed carefully so as not to damage the structure.

The material shall be handled and placed in such a manner as to prevent segregation.

Free draining backfill shall be deposited in horizontal layers not more than 150 mm thick after being compacted, and shall be thoroughly wetted for the purpose of compaction, as determined by the Engineer, and the moisture content shall be uniform throughout the layer.

Free draining backfill shall be compacted with 2 passes of a vibratory plate compactor having a minimum static mass of 100 kg.

103.3.5 Basis of Payment

The accepted quantities, measured as prescribed in Section 103.3, shall be paid for at the contract unit price for each of the particular pay items listed below that is included in the Bill of Quantities. The payment shall constitute full compensation for the removal and disposal of excavated materials including all labor, equipment, tools and incidentals necessary to complete the work prescribed in this Item, except as follows:

Any excavation for footings ordered at a depth more than 1.5m below the lowest elevation shown on the original Contract Plans will be paid for as provided in Part K, Measurement and Payment, unless a pay item for excavation ordered below Plan elevation appears in the Bill of Quantities.

Concrete will be measured and paid for as provided under Item 405, Structural Concrete. Any roadway or borrow excavation required in excess of the quantity excavated for structures will be measured and paid for as provided under Item 102.

Payment will be made under:

Pay Item Number	Description	Unit of Measurement
103 (1)	Structure Excavation	Cubic Meter
103 (2)	Backfill (from structural excavation)	Cubic Meter
103 (3)	Foundation Fill	Cubic Meter
103 (4)	Excavation ordered below Plan elevation	Cubic Meter
103 (6)	Pipe culverts and drain excavation	Cubic Meter

ITEM 104 – EMBANKMENT

104.1 Description

This Item shall consist of the construction of embankment in accordance with this Specification and in conformity with the lines, grades and dimensions shown on the Plans or established by the Engineer.

104.2 *Material Requirements*

Embankments shall be constructed of suitable materials, in consonance with the following definitions:

1. Suitable Material – Material which is acceptable in accordance with the Contract and which can be compacted in the manner specified in this Item. It can be common material or rock.

Selected Borrow, for topping – soil of such gradation that all particles will pass a sieve with 75 mm (3 inches) square openings and not more than 15 mass percent will pass the 0.075 mm (No. 200) sieve, as determined by AASHTO T 11. The material shall have a plasticity index of not more than 6 as determined by ASSHTO T 90 and a liquid limit of not more than 30 as determined by AASHTO T 89.

2. Unsuitable Material – Material other than suitable materials such as:
 - (a) Materials containing detrimental quantities of organic materials, such as grass, roots and sewerage.
 - (b) Organic soils such as peat and muck.

- (c) Soils with liquid limit exceeding 80 and/or plasticity index exceeding 55.
- (d) Soils with a natural water content exceeding 100%.
- (e) Soils with very low natural density, 800 kg/m³ or lower.
- (f) Soils that cannot be properly compacted as determined by the Engineer.

104.3 Construction Requirements

104.3.1 General

Prior to construction of embankment, all necessary clearing and grubbing in that area shall have been performed in conformity with Item 100, Clearing and Grubbing.

Embankment construction shall consist of constructing roadway embankments, including preparation of the areas upon which they are to be placed; the construction of dikes within or adjacent to the roadway; the placing and compacting of approved material within roadway areas where unsuitable material has been removed; and the placing and compacting of embankment material in holes, pits, and other depressions within the roadway area.

Embankments and backfills shall contain no muck, peat, sod, roots or other deleterious matter. Rocks, broken concrete or other solid, bulky materials shall not be placed in embankment areas where piling is to be placed or driven.

Where shown on the Plans or directed by the Engineer, the surface of the existing ground shall be compacted to a depth of 150 mm (6 inches) and to the specified requirements of this Item.

Where provided on the Plans and Bill of Quantities the top portions of the roadbed in both cuts and embankments, as indicated, shall consist of selected borrow for topping from excavations.

104.3.2 Methods of Construction

Where there is evidence of discrepancies on the actual elevations and that shown on the Plans, a preconstruction survey referred to the datum plane used in the approved Plan shall be undertaken by the Contractor under the control of the Engineer to serve as basis for the computation of the actual volume of the embankment materials.

When embankment is to be placed and compacted on hillsides, or when new embankment is to be compacted against existing embankments, or when embankment is built one-half width at a time, the existing slopes that are steeper than 3:1 when measured at right angles to the roadway shall be continuously benched over those areas as the work is brought up in layers. Benching will be subject to the Engineer's approval and shall be of sufficient width to permit operation of placement and compaction equipment. Each horizontal cut shall begin at the intersection of the original ground and the vertical sides of the previous cuts. Material thus excavated shall be placed and compacted along with the embankment material in accordance with the procedure described in this Section.

Unless shown otherwise on the Plans or special Provisions, where an embankment of less than 1.2 m (4 feet) below subgrade is to be made, all sod and vegetable matter shall be removed from the surface upon which the embankment is to be placed, and the cleared surfaced shall be completely broken up by plowing, scarifying, or steeping to a minimum depth of 150 mm except as provided in Subsection 102.2.2. This area shall then be compacted as provided in Subsection 104.3.3. Sod not required to be removed shall be thoroughly disc harrowed or scarified before construction of embankment. Wherever a compacted road surface containing granular materials lies within 900 mm (36 inches) of the subgrade, such old road surface shall be scarified to a depth of at least 150 mm (6 inches) whenever directed by the Engineer. This scarified materials shall then be compacted as provided in Subsection 104.3.3.

When shoulder excavation is specified, the roadway shoulders shall be excavated to the depth and width shown on the Plans. The shoulder material shall be removed without disturbing the adjacent existing base course material, and all excess excavated materials shall be disposed off as provided in Subsection 102.2.3. If necessary, the areas shall be compacted before being backfilled.

Roadway embankment of earth material shall be placed in horizontal layers not exceeding 200 mm (8 inches), loose measurement, and shall be compacted as specified before the next layer is placed. However, thicker layer maybe placed if vibratory roller with high compactive effort is used provided that density requirement is attained and as approved by the Engineer. Trial section to this effect must be conducted and approved by the Engineer. Effective spreading equipment shall be used on each lift to obtain uniform thickness as determined in the trial section prior to compaction. As the compaction of each layer progresses, continuous leveling and manipulating will be required to assure uniform density. Water shall be added or removed, if necessary, in order to obtain the required density. Removal of water shall be accomplished through aeration by plowing, blading, discing, or other methods satisfactory to the Engineer.

Where embankment is to be constructed across low swampy ground that will not support the mass of trucks or other hauling equipment, the lower part of the fill may be constructed by dumping successive loads in a uniformly distributed layer of a thickness not greater than necessary to support the hauling equipment while placing subsequent layers.

When excavated material contains more than 25 mass percent of rock larger than 150 mm in greatest diameter and cannot be placed in layers of the thickness prescribed without crushing, pulverizing or further breaking down the pieces resulting from excavation methods, such materials may be placed on the embankment in layers not exceeding in thickness the approximate average size of the larger rocks, but not greater than 600 mm (24 inches).

Even though the thickness of layers is limited as provided above, the placing of individual rocks and boulders greater than 600 mm in diameter will be permitted provided that when placed, they do not exceed 1200 mm (48 inches) in height and provided they are carefully distributed, with the interstices filled with finer material to form a dense and compact mass.

Each layer shall be leveled and smoothed with suitable leveling equipment and by distribution of spalls and finer fragments of earth. Lifts of material containing more than 25 mass percent of rock larger than 150 mm in greatest dimensions shall not be constructed above an elevation 300 mm (12 inches) below the finished subgrade. The balance of the embankment shall be composed of suitable material smoothed and placed in layers not exceeding 200 mm (8 inches) in loose thickness and compacted as specified for embankments.

Dumping and rolling areas shall be kept separate, and no lift shall be covered by another until compaction complies with the requirements of Subsection 104.3.3.

Hauling and leveling equipment shall be so routed and distributed over each layer of the fill in such a manner as to make use of compaction effort afforded thereby and to minimize rutting and uneven compaction.

104.3.3 *Compaction*

Compaction Trials

Before commencing the formation of embankments, the Contractor shall submit in writing to the Engineer for approval his proposals for the compaction of each type of fill material to be used in the works. The proposals shall include the relationship between the types of compaction equipment, and the number of passes required and the method of adjusting moisture content. The Contractor shall carry out full scale compaction trials on areas not less than 10 m wide and 50 m long as required by the Engineer and using his proposed procedures or such amendments thereto as may be found necessary to satisfy the Engineer that all the specified requirements regarding compaction can be consistently achieved. Compaction trials with the main types of fill material to be used in the works shall be completed before work with the corresponding materials will be allowed to commence.

Throughout the periods when compaction of earthwork is in progress, the Contractor shall adhere to the compaction procedures found from compaction trials for each type of material being compacted, each type of compaction equipment employed and each degree of compaction specified.

Earth

The Contractor shall compact the material placed in all embankment layers and the material scarified to the designated depth below subgrade in cut sections, until a uniform density of not less than 95 mass percent of the maximum dry density determined by AASHTO T 99 Method C, is attained, at a moisture content determined by Engineer to be suitable for such density. Acceptance of compaction may be based on adherence to an approved roller pattern developed as set forth in Item 106, Compaction Equipment and Density Control Strips.

The Engineer shall during progress of the Work, make density tests of compacted material in accordance with AASHTO T 191, T 205, or other approved field density tests, including the use of properly calibrated nuclear testing devices. A correction for coarse particles may be made in accordance with AASHTO T 224. If, by such tests, the Engineer determines that the specified density and moisture conditions have not been attained, the Contractor shall perform additional work as may be necessary to attain the specified conditions.

At least one group of three in-situ density tests shall be carried out for each 500 m of each layer of compacted fill.

Rock

Density requirements will not apply to portions of embankments constructed of materials which cannot be tested in accordance with approved methods.

Embankment materials classified as rock shall be deposited, spread and leveled the full width of the fill with sufficient earth or other fine material so deposited to fill the interstices to produce a dense compact embankment. In addition, one of the rollers, vibrators, or compactors meeting the requirements set forth in Subsection 106.2.1, Compaction Equipment, shall compact the embankment full width with a minimum of three complete passes for each layer of embankment.

104.3.4 Protection of Roadbed During Construction

During the construction of the roadway, the roadbed shall be maintained in such condition that it will be well drained at all times. Side ditches or gutters emptying from cuts to

embankments or otherwise shall be so constructed as to avoid damage to embankments by erosion.

104.3.5 *Protection of Structure*

If embankment can be deposited on one side only of abutments, wing walls, piers or culvert headwalls, care shall be taken that the area immediately adjacent to the structure is not compacted to the extent that it will cause overturning of, or excessive pressure against the structure. When noted on the Plans, the fill adjacent to the end bent of a bridge shall not be placed higher than the bottom of the backfill of the bent until the superstructure is in place. When embankment is to be placed on both sides of a concrete wall or box type structure, operations shall be so conducted that the embankment is always at approximately the same elevation on both sides of the structure.

104.3.6 *Rounding and Warping Slopes*

Rounding-Except in solid rock, the tops and bottoms of all slopes, including the slopes of drainage ditches, shall be rounded as indicated on the Plans. A layer of earth overlaying rock shall be rounded above the rock as done in earth slopes.

Warping-adjustments in slopes shall be made to avoid injury in standing trees or marring of weathered rock, or to harmonize with existing landscape features, and the transition to such adjusted slopes shall be gradual. At intersections of cuts and fills, slopes shall be adjusted and warped to flow into each other or into the natural ground surfaces without noticeable break.

104.3.7 *Finishing Roadbed and Slopes*

After the roadbed has been substantially completed, the full width shall be conditioned by removing any soft or other unstable material that will not compact properly or serve the intended purpose. The resulting areas and all other low sections, holes or depressions shall be brought to grade with suitable selected material. Scarifying, blading, dragging, rolling, or other methods of work shall be performed or used as necessary to provide a thoroughly compacted roadbed shaped to the grades and cross-sections shown on the Plans or as staked by the Engineer.

All earth slopes shall be left with roughened surfaces but shall be reasonably uniform, without any noticeable break, and in reasonably close conformity with the Plans or other surfaces indicated on the Plans or as staked by the Engineer, with no variations therefrom readily discernible as viewed from the road.

104.3.8 *Serrated Slopes*

Cut slopes in rippable material (soft rock) having slope ratios between 0.75:1 and 2:1 shall be constructed so that the final slope line shall consist of a series of small horizontal steps. The step rise and tread dimensions shall be shown on the Plans. No scaling shall be performed on the stepped slopes except for removal of large rocks which will obviously be a safety hazard if they fall into the ditchline or roadway.

104.3.9 *Earth Berms*

When called for in the Contract, permanent earth berms shall be constructed of well graded materials with no rocks having a diameter greater than 0.25 the height of the berm. When local material is not acceptable, acceptable material shall be imported, as directed by the Engineer.

Compacted Berm

Compacted berm construction shall consist of moistening or drying and placing material as necessary in locations shown on the drawings or as established by the Engineer. Material shall contain no frozen material, roots, sod, or other deleterious materials. Contractor shall take precaution to prevent material from escaping over the embankment slope. Shoulder surface beneath berm will be roughened to provide a bond between the berm and shoulder when completed. The Contractor shall compact the material placed until at least 90 mass percent of the maximum density is obtained as determined by AASHTO T 99, Method C. The cross-section of the finished compacted berm shall reasonably conform to the typical cross-section as shown on the Plans.

Uncompacted Berm

Uncompacted berm construction shall consist of drying, if necessary and placing material in locations shown on the Plans or as established by the Engineer. Material shall contain no frozen material, roots, sod or other deleterious materials. Contractor shall take precautions to prevent material from escaping over the embankment slope.

104.4 *Method of Measurement*

The quantity of embankment to be paid for shall be the volume of material compacted in place, accepted by the Engineer and formed with material obtained from any source.

Material from excavation per Item 102 which is used in embankment and accepted by the Engineer will be paid under Embankment and such payment will be deemed to include the cost of excavating, hauling, stockpiling and all other costs incidental to the work.

Material for Selected Borrow topping will be measured and paid for under the same conditions specified in the preceding paragraph.

104.5 Basis of Payment

The accepted quantities, measured as prescribed in Section 104.4, shall be paid for at the Contract unit price for each of the Pay Items listed below that is included in the Bill of Quantities. The payment shall continue full compensation for placing and compacting all materials including all labor, equipment, tools and incidentals necessary to complete the work prescribed in this Item.

Payment will be made under:

Pay Item Number	Description	Unit of Measurement
104 (1)	Embankment	Cubic Meter
104 (2)	Selected, Borrow for topping, Case 1	Cubic Meter
104 (3)	Selected Borrow for topping, Case 2	Cubic Meter
104 (4)	Earth Berm	Meter

ITEM 105 – SUBGRADE PREPARATION

105.1 Description

This Item shall consist of the preparation of the subgrade for the support of overlying structural layers. It shall extend to full width of the roadway. Unless authorized by the Engineer, subgrade preparation shall not be done unless the Contractor is able to start immediately the construction of the pavement structure.

105.2 Material Requirements

Unless otherwise stated in the Contract and except when the sub grade is in rock cut, all materials below sub grade level to a depth 150 mm or to such greater depth as may be specified shall meet the requirements of Section 104.2, Selected Borrow for Topping.

105.3 Construction Requirements

105.3.1 Prior Works

Prior to commencing preparation of the sub grade, all culverts, cross drains, ducts and the like (including their fully compacted backfill), ditches, drains and drainage outlets shall be completed. Any work on the preparation of the subgrade shall not be started unless prior work herein described shall have been approved by the Engineer.

105.3.2 Subgrade Level Tolerances

The finished compacted surface of the subgrade shall conform to the allowable tolerances as specified hereunder:

Permitted variation from	+	20 mm
design LEVEL OF SURFACE	-	30 mm
Permitted SURFACE IRREGULARITY		
MEASURED BY 3-m STRAIGHT EDGE		30 mm

Permitted variation from		
design CROSSFALL OR CAMBER	±	0.5 %
Permitted variation from	±	0.1 %
design LONGITUDINAL GRADE		
over 25 m length		

105.3.3 Subgrade in Common Excavation

Unless otherwise specified, all materials below subgrade level in earth cuts to a depth 150 mm or other depth shown on the Plans or as directed by the Engineer shall be excavated. The material, if suitable, shall be set aside for future use or, if unsuitable, shall be disposed off in accordance with the requirements of Subsection 102.2.9.

Where material has been removed from below subgrade level, the resulting surface shall be compacted to a depth of 150 mm and in accordance with other requirements of Subsection 104.3.3.

All materials immediately below subgrade level in earth cuts to a depth of 150 mm, or to such greater depth as may be specified, shall be compacted in accordance with the requirements of Subsection 104.3.3.

105.3.4 Subgrade in Rock Excavation

Surface irregularities under the subgrade level remaining after trimming of the rock excavation shall be leveled by placing specified material and compacted to the requirements of Subsection 104.3.3.

105.3.5 Subgrade on Embankment

After the embankment has been completed, the full width shall be conditioned by removing any soft or other unstable material that will not compacted properly. The resulting areas and all other low sections, holes, or depressions shall be brought to grade with suitable material. The entire roadbed shall be shaped and compacted to the requirements of Subsections 104.3.3. Scarifying, blading, dragging, rolling, or other methods of work shall be performed or used as necessary to provide a thoroughly compacted roadbed shaped to the cross-sections shown on the Plans.

105.3.6 Subgrade on Existing Pavement

Where the new pavement is to be constructed immediately over an existing Portland Cement concrete pavement and if so specified in the Contract the slab be broken into pieces with greatest dimension of not more than 500 mm and the existing pavement material compacted as specified in Subsection 104.3.3, as directed by the Engineer. The resulting subgrade level shall, as part pavement construction be shaped to conform to the allowable tolerances of Subsection 105.3.2 by placing and compacting where necessary a leveling course comprising the material of the pavement course to be placed immediately above.

Where the new pavement is to be constructed immediately over an existing asphalt concrete pavement or gravel surface pavement and if so specified in the Contract the pavement shall be scarified, thoroughly loosened, reshaped and recompactd in accordance with Subsection 104.3.3. The resulting subgrade level shall conform to the allowable tolerances of Subsection 105.3.2.

105.3.7 Protection of Completed Work

The Contractor shall be required to protect and maintain at his own expense the entire work within the limits of his Contract in good condition satisfactory to the Engineer from the time he first started work until all work shall have been completed. Maintenance shall include repairing and recompactd ruts, ridges, soft spots and deteriorated sections of the subgrade caused by the traffic of the Contractor's vehicle/equipment or that of the public.

105.3.8 Templates and Straight-edges

The Contractor shall provide for use of the Engineer, approved templates and straight-edges in sufficient number to check the accuracy of the work, as provided in this Specification.

105.4 Method of Measurement

105.4.1 Measurement of Items for payment shall be provided only for:

The compaction of existing ground below subgrade level in cuts of common material as specified in Subsection 105.3.3.

The breaking up or scarifying, loosening, reshaping and recompactd of existing pavement as specified in Subsection 105.3.6. The quantity to be paid for shall be the area of the work specified to be carried out and accepted by the Engineer.

105.4.2 Payment for all work for the preparation of the subgrade, including shaping to the required levels and tolerances, other than as specified above shall be deemed to be included in the Pay Item for Embankment.

105.5 Basis of Payment

The accepted quantities, measured as prescribed in Section 105.4, shall be paid for at the appropriate contract unit price for Pay Item listed below that is included in the Bill of Quantities which price and payment shall be full compensation for the placing or removal and disposal of all materials including all labor, equipment, tools and incidentals necessary to complete the work prescribed in this Item.

Payment will be made under:

Pay Item Number	Description	Unit of Measurement
105 (1)	Subgrade Preparation (Common Material)	Square Meter
105 (2)	Subgrade Preparation (Existing Pavement)	Square Meter
105 (3)	Subgrade Preparation (Unsuitable Material)	Square Meter

ITEM 200 – AGGREGATE SUBBASE COURSE

Description

This item shall consist of furnishing, placing and compacting an aggregate subbase course on a prepared subgrade in accordance with this Specification and the lines, grades and cross- sections shown on the Plans, or as directed by the Engineer.

Material Requirements

Aggregate for subbase shall consist of hard, durable particles or fragments of crushed stone, crushed slag, or crushed or natural gravel and filler of natural or crushed sand or other finely divided mineral matter. The composite material shall be free from vegetable matter and lumps or balls of clay, and shall be of such nature that it can be compacted readily to form a firm, stable subbase.

The subbase material shall conform to Table 200.1, Grading Requirements

Table 200.1 – Grading Requirements

Sieve Designation		Mass Percent Passing
Standard, mm	Alternate US Standard	
50	2"	100
25	1"	55 – 85
9.5	3/8"	40 – 75
0.075	No. 200	0 - 12

The fraction passing the 0.075 mm (No. 200) sieve shall not be greater than 0.66 (two thirds) of the fraction passing the 0.425 mm (No. 40) sieve.

The fraction passing the 0.425 mm (No. 40) sieve shall have a liquid limit not greater than 35 and plasticity index not greater than 12 as determined by AASHTO T 89 and T 90, respectively.

The coarse portion, retained on a 2.00 mm (No. 10) sieve, shall have a mass percent of wear not exceeding 50 by the Los Angeles Abrasion Tests as determined by AASHTO T 96.

The material shall have a soaked CBR value of not less than 25% as determined by AASHTO T 193. The CBR value shall be obtained at the maximum dry density and determined by AASHTO T 180, Method D.

Construction Requirements

200.3.1 Preparation of Existing Surface

The existing surface shall be graded and finished as provided under Item 105, Subgrade Preparation, before placing the subbase material.

200.3.2 Placing

The aggregate subbase material shall be placed at a uniform mixture on a prepared subgrade in a quantity which will provide the required compacted thickness. When more than one layer is required, each layer shall be shaped and compacted before the succeeding layer is placed.

The placing of material shall begin at the point designated by the Engineer. Placing shall be from vehicles especially equipped to distribute the material in a continuous uniform layer or windrow. The layer or windrow shall be of such size that when spread and compacted the finished layer be in reasonably close conformity to the nominal thickness shown on the Plans.

When hauling is done over previously placed material, hauling equipment shall be dispersed uniformly over the entire surface of the previously constructed layer, to minimize rutting or uneven compaction.

200.3.3 Spreading and Compacting

When uniformly mixed, the mixture shall be spread to the plan thickness, for compaction.

Where the required thickness is 150 mm or less, the material may be spread and compacted in one layer. Where the required thickness is more than 150 mm, the aggregate subbase shall be spread and compacted in two or more layers of approximately equal thickness, and the maximum compacted thickness of any layer shall not exceed 150 mm. All subsequent layers shall be spread and compacted in a similar manner.

The moisture content of subbase material shall, if necessary, be adjusted prior to compaction by watering with approved sprinklers mounted on trucks or by drying out, as required in order to obtain the required compaction.

Immediately following final spreading and smoothing, each layer shall be compacted to the full width by means of approved compaction equipment. Rolling shall progress gradually from the sides to the center, parallel to the centerline of the road and shall continue until the whole surface has been rolled. Any irregularities or depressions that develop shall be corrected by loosening the material at these places and adding or removing material until surface is smooth and uniform. Along curbs, headers, and walls, and at all places not accessible to the roller, the subbase material shall be compacted thoroughly with approved tampers or compactors.

If the layer of subbase material, or part thereof, does not conform to the required finish, the Contractor shall, at his own expense, make the necessary corrections.

Compaction of each layer shall continue until a field density of at least 100 percent of the maximum dry density determined in accordance with AASHTO T 180, Method D has been achieved. In-place density determination shall be made in accordance with AASHTO T 191.

200.3.4 Trial Sections

Before subbase construction is started, the Contractor shall spread and compact trial sections as directed by the Engineer. The purpose of the trial sections is to check the suitability of the materials and the efficiency of the equipment and construction method which is proposed to be used by the Contractor. Therefore, the Contractor must use the same material, equipment and procedures that he proposes to use for the main work. One trial section of about 500 m² shall be made for every type of material and/or construction equipment/procedure proposed for use.

After final compaction of each trial section, the Contractor shall carry out such field density tests and other tests required as directed by the Engineer.

If a trial section shows that the proposed materials, equipment or procedures in the Engineer's opinion are not suitable for subbase, the material shall be removed at the Contractor's expense, and a new trial section shall be constructed.

If the basic conditions regarding the type of material or procedure change during the execution of the work, new trial sections shall be constructed.

200.3.5 Tolerances

Aggregate subbase shall be spread with equipment that will provide a uniform layer which when compacted will conform to the designed level and transverse slopes as shown on the Plans. The allowable tolerances shall be as specified hereunder:

Permitted variation from design	± 20 mm
THICKNESS OF LAYER	
Permitted variation from design	+10 mm

LEVEL OF SURFACE	-20 mm
Permitted SURFACE IRREGULARITY	
Measured by 3-m straight-edge	20 mm
Permitted variation from design	
CROSSFALL OR CAMBER	±0.3%
Permitted variation from design	
LONGITUDINAL GRADE	
over	
25 m in length	±0.1%

Method of Measurement

Aggregate Subbase Course will be measured by the cubic meter (m³). The quantity to be paid for shall be the design volume compacted in-place as shown on the Plans, and accepted in the completed course. No allowance will be given for materials placed outside the design limits shown on the cross-sections. Trial sections shall not be measured separately but shall be included in the quantity of subbase herein measured.

Basis of Payment

The accepted quantities, measured as prescribed in Section 200.4, shall be paid for at the contract unit price for Aggregate Subbase Course which price and payment shall be full compensation for furnishings and placing all materials, including all labor, equipment, tools and incidentals necessary to complete the work prescribed in this Item.

Payment will be made under:

Pay Item Number	Description	Unit of Measurement
200	Aggregate Subbase Course	Cubic Meter

ITEM 311 – PORTLAND CEMENT CONCRETE PAVEMENT

311.1 Description

This Item shall consist of pavement of Portland Cement Concrete, with or without reinforcement, constructed on the prepared base in accordance with this Specification and in conformity with lines, grades, thickness and typical cross-section shown on the Plans.

311.2 Material Requirements

311.2.1 Portland Cement

It shall conform to the applicable requirements of Item 700, Hydraulic Cement. Only Type I Portland Cement shall be used unless otherwise provided for in the Special Provisions. Different brands or the same brands from different mills shall not be mixed nor shall they be used alternately unless the mix is approved by the Engineer. However, the use of Portland Pozzolan Cement Type IP meeting the requirements of AASHTO M 240/ASTM C 695, Specifications for Blended Hydraulic Cement shall be allowed, provided that trial mixes shall be done and that the mixes meet the concrete strength requirements, the AASHTO/ASTM provisions pertinent to the use of Portland Pozzolan Type IP shall be adopted.

Cement which for any reason, has become partially set or which contains lumps of caked cement will be rejected. Cement salvaged from discarded or used bags shall not be used.

Samples of Cement shall be obtained in accordance with AASHTO T 127.

311.2.2 Fine Aggregate

It shall consist of natural sand, stone screenings or other inert materials with similar characteristics, or combinations thereof, having hard, strong and durable particles. Fine aggregate from different sources of supply shall not be mixed or stored in the same pile nor used alternately in the same class of concrete without the approval of the Engineer.

It shall not contain more than three (3) mass percent of material passing the 0.075 mm (No. 200 sieve) by washing nor more than one (1) mass percent each of clay lumps or shale. The use of beach sand will not be allowed without the approval of the Engineer.

If the fine aggregate is subjected to five (5) cycles of the sodium sulfate soundness test, the weighted loss shall not exceed 10 mass percent.

The fine aggregate shall be free from injurious amounts of organic impurities. If subjected to the colorimetric test for organic impurities and a color darker than the standard is produced, it shall be rejected. However, when tested for the effect of organic impurities of strength of mortar by AASHTO T 71, the fine aggregate may be used if the relative strength at 7 and 28 days is not less than 95 mass percent.

The fine aggregate shall be well-graded from coarse to fine and shall conform to Table 311.1

Table 311.1 – Grading Requirements for Fine Aggregate

Sieve Designation	Mass Percent Passing
9.5 mm (3/8 in)	100
4.75 mm (No. 4)	95 – 100
2.36 mm (No. 8)	-
1.18 mm (No. 16)	45 – 80
0.600 mm (No. 30)	-
0.300 mm (No. 50)	5 – 30
0.150 mm (No. 100)	0 – 10

311.2.3 Coarse Aggregate

It shall consist of crushed stone, gravel, blast furnace slag, or other approved inert materials of similar characteristics, or combinations thereof, having hard, strong, durable pieces and free from any adherent coatings.

It shall contain not more than one (1) mass percent of material passing the 0.075 mm (No. 200) sieve, not more than 0.25 mass percent of clay lumps, nor more than 3.5 mass percent of soft fragments.

If the coarse aggregate is subjected to five (5) cycles of the sodium sulfate soundness test, the weighted loss shall not exceed 12 mass percent.

It shall have a mass percent of wear not exceeding 40 when tested by AASHTO T 96.

If the slag is used, its density shall not be less than 1120 kg/m³ (70 lb./cu. ft.). The gradation of the coarse aggregate shall conform to Table 311.2.

Only one grading specification shall be used from any one source.

Table 311.2 – Grading Requirement for Coarse Aggregate

Sieve Designation		Mass Percent Passing		
Standard Mm	Alternate U. S. Standard	Grading A	Grading B	Grading C
75.00	3 in.	100	-	-
63.00	2-1/2 in.	90-100	100	100
50.00	2 in.	-	90-100	95-100
37.5	1-1/2 in.	25-60	35-70	-
25.0	1 in.	-	0-15	35-70
19.0	¾ in.	0-10	-	-
12.5	½ in.	0-5	0-5	10-30
4.75	No. 4	-	-	0-5

311.2.4 Water

Water used in mixing, curing or other designated application shall be reasonably clean and free of oil, salt, acid, alkali, grass or other substances injurious to the finished product. Water will be tested in accordance with and shall meet the requirements of Item 714, Water.

Water which is drinkable may be used without test. Where the source of water is shallow, the intake shall be so enclosed as to exclude silt, mud, grass or other foreign materials

311.2.5 Reinforcing Steel

It shall conform to the requirements of Item 404, Reinforcing Steel. Dowels and tie bars shall conform to the requirements of AASHTO M 31 or M 42, except that rail steel shall not be used for tie bars that are to be bent and restraightened during construction. Tie bars shall be deformed bars. Dowels shall be plain round bars. Before delivery to the site of work, one-half of the length of each dowel shall be painted with one coat of approved lead or tar paint.

The sleeves for dowel bars shall be metal of approved design to cover 50 mm (2 inches), plus or minus 5 mm (1/4 inch) of the dowel, with a closed end, and with a suitable stop to hold the end of the sleeve at least 25 mm (1 inch) from the end of the dowel. Sleeves shall be of such design that they do not collapse during construction.

311.2.6 Joint Fillers

Poured joint fillers shall be mixed asphalt and mineral or rubber filler conforming to the applicable requirements of Item 705, Joint Materials.

Preformed joint filler shall conform to the applicable requirements of Item 705. It shall be punched to admit the dowels where called for in the Plans. The filler for each joint shall be furnished in a single piece for the full depth and width required for the joint.

311.2.7 Admixtures

Air-entraining admixture shall conform to the requirements of AASHTO M 154.

Chemical admixtures, if specified or permitted, shall conform to the requirements of AASHTO M 194.

Fly Ash, if specified or permitted as a mineral admixture and as 20% partial replacement of Portland Cement in concrete mix shall conform to the requirements of ASTM C 618.

Admixture should be added only to the concrete mix to produce some desired modifications to the properties of concrete where necessary, but not as partial replacement of cement.

311.2.8 Curing Materials

Curing materials shall conform to the following requirements as specified;

- a) Burlap cloth - AASHTO M 182
- b) Liquid membrane forming compounds - AASHTO M 148
- c) Sheeting (film) materials - AASHTO M 171

Cotton mats and water-proof paper can be used.

311.2.9 Calcium Chloride/Calcium Nitrate

It shall conform to AASHTO M 144, if specified or permitted by the Engineer, as accelerator

311.2.10 Storage of Cement and Aggregate

All cement shall be stored, immediately upon delivery at the Site, in weatherproof building which will protect the cement from dampness. The floor shall be raised from the ground. The buildings shall be placed in locations approved by the Engineer. Provisions for storage shall be ample, and the shipments of cement as received shall be separately stored in such a manner as to allow the earliest deliveries to be used first and to provide easy access for identification and inspection of each shipment. Storage buildings shall have capacity for storage of a sufficient quantity of cement to allow sampling at least twelve (12) days before the cement is to be used. Bulk cement, if used, shall be transferred to elevated air tight and weatherproof bins. Stored cement shall meet the test requirements at any time after storage when retest is ordered by the Engineer. At the time of use, all cement shall be free-flowing and free of lumps.

The handling and storing of concrete aggregates shall be such as to prevent segregation or the inclusion of foreign materials. The Engineer may require that aggregates be stored on separate platforms at satisfactory locations.

In order to secure greater uniformity of concrete mix, the Engineer may require that the coarse aggregate be separated into two or more sizes. Different sizes of aggregate shall be stored in separate bins or in separate stockpiles sufficiently removed from each other to prevent the material at the edges of the piles from becoming intermixed.

311.2.11 Proportioning, Consistency and Strength of Concrete

The Contractor shall prepare the design mix based on the absolute volume method as outlined in the American Concrete Institute (ACI) Standard 211.1, "Recommended Practice for Selecting Proportions for Normal and Heavyweight Concrete".

It is the intent of this Specification to require at least 364 kg of cement per cubic meter of concrete to meet the minimum strength requirements. The Engineer shall determine from laboratory tests of the materials to be used, the cement content and the proportions of aggregate

and water that will produce workable concrete having a slump of between 40 and 75 mm (1-1/2 and 3 inches) if not vibrated or between 10 and 40 mm (1/2 and 1-1/2 inches) if vibrated, and a flexural strength of not less than 3.8 MPa (550 psi) when tested by the third-point method or 4.5 MPa (650 psi) when tested by the mid-point method at fourteen (14) days in accordance with AASHTO T97 and T177, respectively; or a compressive strength of 24.1 MPa (3500 psi) for cores taken at fourteen (14) days and tested in accordance with AASHTO T24.

Slump shall be determined using AASHTO T 119.

The designer shall consider the use of lean concrete (econocrete) mixtures using local materials or specifically modified conventional concrete mixes in base course and in the lower course composite, monolithic concrete pavements using a minimum of 75 mm (3 inches) of conventional concrete as the surface course.

The mix design shall be submitted to the Engineer for approval and shall be accompanied with certified test data from an approved laboratory demonstrating the adequacy of the mix design. A change in the source of materials during the progress of work may necessitate a new design mix.

311.3 Construction Requirements

311.3.1 Quality Control of Concrete

1. General

The Contractor shall be responsible for the quality control of all materials during the handling, blending, and mixing and placement operations.

2. Quality Control Plan

The Contractor shall furnish the Engineer a Quality Control Plan detailing his production control procedures and the type and frequency of sampling and testing to insure that the concrete produces complies with the Specifications. The Engineer shall be provided free access to recent plant production records, and if requested, informational copies of mix design, materials certifications and sampling and testing reports.

3. Qualification of Workmen

Experienced and qualified personnel shall perform all batching or mixing operation for the concrete mix, and shall be present at the plant and job site to control the concrete productions whenever the plant is in operation. They shall be identified and duties defined as follows:

a. Concrete Batcher. The person performing the batching or mixing operation shall be capable of accurately conducting aggregate surface moisture determination and establishing correct scale weights for concrete materials. He shall be capable of assuring that the proportioned batch weights of materials are in accordance with the mix design.

b. Concrete Technician. The person responsible for concrete production control and sampling and testing for quality control shall be proficient in concrete technology and shall have a sound knowledge of the Specifications as they relate to concrete production. He shall be capable of conducting tests on concrete and concrete materials in accordance with these Specifications. He shall be capable of adjusting concrete mix designs for improving workability and Specification compliance and preparing trial mix designs. He shall be qualified to act as the concrete batcher in the batcher's absence.

4. Quality Control Testing

The Contractor shall perform all sampling, testing and inspection necessary to assure quality control of the component materials and the concrete.

The Contractor shall be responsible for determining the gradation of fine and coarse aggregates and for testing the concrete mixture for slump, air content, water-cement ratio and temperature. He shall conduct his operations so as to produce a mix conforming to the approved mix design.

5. Documentation

The Contractor shall maintain adequate records of all inspections and tests. The records shall indicate the nature and number of observations made, the number and type of deficiencies found, the quantities approved and rejected, and nature of any corrective action taken.

The Engineer may take independent assurance samples at random location for acceptance purposes as he deems necessary.

311.3.2 Equipment

Equipment and tools necessary for handling materials and performing all parts of the work shall be approved by the Engineer as to design, capacity and mechanical condition. The equipment shall be at the jobsite sufficiently ahead of the start of construction operations to be examined thoroughly and approved.

1. Batching Plant and Equipment

a. General. The batching shall include bins, weighing hoppers, and scales for the fine aggregate and for each size of coarse aggregate. If cement is used in bulk, a bin, a hopper, and separate scale for cement shall be included. The weighing hopper shall be properly sealed and vented to preclude dusting operation. The batch plant shall be equipped with a suitable non-resettable batch counter which will correctly indicate the number of batches proportioned.

b. Bins and Hoppers. Bins with adequate separate compartments for fine aggregate and for each size of coarse aggregate shall be provided in the batching plant.

c. Scales. Scales for weighing aggregates and cement shall be of either the beam type or the springless-dial type. They shall be accurate within one-half percent (0.5%) throughout the range of use. Poises shall be designed to be locked in any position and to prevent unauthorized change.

Scales shall be inspected and sealed as often as the Engineer may deem necessary to assure their continued accuracy.

Automatic Weighing Devices. Unless otherwise allowed on the Contract, batching plants shall be equipped with automatic weighing devices of an approved type to proportion aggregates and bulk cement.

2. Mixers.

a. General. Concrete may be mixed at the Site of construction or at a central plant, or wholly or in part in truck mixers. Each mixer shall have a manufacturer's plate attached in a prominent place showing the capacity of the drum in terms of volume of mixed concrete and the speed of rotation of the mixing drum or blades.

b. Mixers at Site of Construction. Mixing shall be done in an approved mixer capable of combining the aggregates, cement and water into a thoroughly mixed and uniform mass within the specified mixing period and discharging and distributing the mixture without segregation on the prepared grade. The mixer shall be equipped with an approved timing device which will automatically lock the discharge lever when the drum has been charged and released it at the end of the mixing period. In case of failure of the timing device, the mixer may be used for the balance of the day while it is being repaired, provided that each batch is mixed 90 seconds. The mixer shall be equipped with a suitable nonresettable batch counter which shall correctly indicate the number of the batches mixed.

c. Truck Mixer and Truck Agitators. Truck mixers used for mixing and hauling concrete, and truck agitators used for hauling central-mixed concrete, shall conform to the requirements of AASHTO M 157.

d. Non-Agitator Truck. Bodies of non-agitating hauling equipment for concrete shall be smooth, mortar-tight metal containers and shall be capable of discharging the concrete at a satisfactory controlled rate without segregation.

3. Paving and Finishing Equipment

The concrete shall be placed with an approved paver designed to spread, consolidate, screed and float finish the freshly placed concrete in one complete pass of the machine in such a manner that a minimum of hand finishing will be necessary to provide a dense and homogeneous pavement in conformance with the Plans and Specifications.

The finishing machine shall be equipped with at least two (2) oscillating type transverse screed.

Vibrators shall operate at a frequency of 8,300 to 9,600 impulses per minute under load at a maximum spacing of 60 cm.

4. Concrete Saw

The Contractor shall provide sawing equipment in adequate number of units and power to complete the sawing with a water-cooled diamond edge saw blade or an abrasive wheel to the required dimensions and at the required rate. He shall provide at least one (1) stand-by saw in good working condition and with an ample supply of saw blades.

5. Forms

Forms shall be of steel, of an approved section, and of depth equal to the thickness of the pavement at the edge. The base of the forms shall be of sufficient width to provide necessary stability in all directions. The flange braces must extend outward on the base to not less than $\frac{2}{3}$ the height of the form.

All forms shall be rigidly supported on bed of thoroughly compacted material during the entire operation of placing and finishing the concrete. Forms shall be provided with adequate devices for secure setting so that when in place, they will withstand, without visible spring or settlement, the impact and vibration of the consolidation and finishing or paving equipment.

311.3.3 Preparation of Grade

After the subgrade of base has been placed and compacted to the required density, the areas which will support the paving machine and the grade on which the pavement is to be constructed shall be trimmed to the proper elevation by means of a properly designed machine extending the prepared work areas compacted at least 60 cm beyond each edge of the proposed concrete pavement. If loss of density results from the trimming operations, it shall be restored by additional compaction before concrete is placed. If any traffic is allowed to use the prepared subgrade or base, the surface shall be checked and corrected immediately ahead of the placing concrete.

The subgrade or base shall be uniformly moist when the concrete is placed.

311.3.4 Setting Forms

1. Base Support.

The foundation under the forms shall be hard and true to grade so that the form when set will be firmly in contact for its whole length and at the specified grade. (Any roadbed, which at the form line is found below established grade, shall be filled with approved granular materials to grade in lifts of three (3) cm or less, and thoroughly rerolled or tamped.) Imperfections or variations above grade shall be corrected by tamping or by cutting as necessary.

2. Form Setting

Forms shall be set sufficiently in advance of the point where concrete is being placed. After the forms have been set to correct grade, the grade shall be thoroughly tamped, mechanically or by hand, at both the inside and outside edges of the base of the forms. The forms shall not deviate from true line by more than one (1) cm at any point.

3. Grade and Alignment

The alignment and grade elevations of the forms shall be checked and corrections made by the Contractor immediately before placing the concrete. Testing as to crown and elevation, prior to placing of concrete can be made by means of holding an approved template in a vertical position and moved backward and forward on the forms.

When any form has been disturbed or any grade has become unstable, the form shall be reset and rechecked.

311.3.5 Conditioning of Subgrade or Base Course

When side forms have been securely set to grade, the subgrade or base course shall be brought to proper cross-section. High areas shall be trimmed to proper elevation. Low areas shall be filled and compacted to a condition similar to that of surrounding grade. The finished grade shall be maintained in a smooth and compacted condition until the pavement is placed.

Unless waterproof subgrade or base course cover material is specified, the subgrade or base course shall be uniformly moist when the concrete is placed. If it subsequently becomes too dry, the subgrade or base course shall be sprinkled, but the method of sprinkling shall not be such as to form mud or pools of water.

311.3.6 Handling, Measuring and Batching Materials

The batch plant site, layout, equipment and provisions for transporting material shall be such as to assure a continuous supply of material to the work.

Stockpiles shall be built up in layers of not more than one (1) meter in thickness. Each layer shall be completely in place before beginning the next which shall not be allowed to “cone” down over the next lower layer. Aggregates from different sources and of different grading shall not be stockpiled together.

All washed aggregates and aggregates produced or handled by hydraulic methods, shall be stockpiled or binned for draining at least twelve (12) hours before being batched.

When mixing is done at the side of the work, aggregates shall be transported from the batching plant to the mixer in batch boxes, vehicle bodies, or other containers of adequate capacity and construction to properly carry the volume required. Partitions separating batches shall be adequate and effective to prevent spilling from one compartment to another while in transit or being dumped. When bulk cement is used, the Contractor shall use a suitable method of handling the cement from weighing hopper to transporting container or into the batch itself for transportation to the mixer, with chute, boot or other approved device, to prevent loss of cement, and to provide positive assurance of the actual presence in each batch of the entire cement content specified.

Bulk cement shall be transported to the mixer in tight compartments carrying the full amount of cement required for the batch. However, if allowed in the Special Provisions, it may be transported between the fine and coarse aggregate. When cement is placed in contact with the aggregates, batches may be rejected unless mixed within 1-1/2 hours of such contact. Cement in original shipping packages may be transported on top of the aggregates, each batch containing the number of sacks required by the job mix.

The mixer shall be charged without loss of cement. Batching shall be so conducted as to result in the weight to each material required within a tolerance of one (1) percent for the cement and two (2) percent for aggregates.

Water may be measured either by volume or by weight. The accuracy of measuring the water shall be within a range of error of not over than one (1) percent. Unless the water is to be weighed, the water-measuring equipment shall include an auxiliary tank from which the measuring tank shall be equipped with an outside tap and valve to provide checking the setting, unless other means are provided for readily and accurately determining the amount of water in the tank. The volume of the auxiliary tank shall be at least equal to that of the measuring tank.

311.3.7 Mixing Concrete

The concrete may be mixed at the site of the work in a central-mix plant, or in truck mixers. The mixer shall be of an approved type and capacity. Mixing time will be measured from the time all materials, except water, are in the drum. Ready-mixed concrete shall be mixed and delivered in accordance with requirements of AASHTO M 157, except that the minimum required revolutions at the mixing speed for transit-mixed concrete may be reduced to not less than that recommended by the mixer manufacturer. The number of revolutions recommended by the mixer manufacturer shall be indicated on the manufacturer’s serial plate attached to the mixer. The Contractor shall furnish test data acceptable to the Engineer verifying that the make and model of the mixer will produce uniform concrete conforming to the provision of AASHTO M 157 at the reduced number of revolutions shown on the serial plate.

When mixed at the site or in a central mixing plant, the mixing time shall not be less than fifty (50) seconds nor more than ninety (90) seconds, unless mixer performance tests prove adequate mixing of the concrete is a shorter time period.

Four (4) seconds shall be added to the specified mixing time if timing starts at the instant the skip reaches its maximum raised positions. Mixing time ends when the discharge chute opens. Transfer time in multiple drum mixers is included in mixing time. The contents of an individual mixer drum shall be removed before a succeeding batch is emptied therein.

The mixer shall be operated at the drum speed as shown on the manufacturer's name plate attached on the mixer. Any concrete mixed less than the specified time shall be discarded and disposed off by the Contractor at his expense. The volume of concrete mixed per batch shall not exceed the mixer's nominal capacity in cubic metre, as shown on the manufacturer's standard rating plate on the mixer, except that an overload up to ten (10) percent above the mixer's nominal capacity may be permitted provided concrete test data for strength, segregation, and uniform consistency are satisfactory, and provided no spillage of concrete takes place.

The batches shall be so charged into the drum that a portion of the mixing water shall be entered in advance of the cement and aggregates. The flow of water shall be uniform and all water shall be in the drum by the end of the first fifteen (15) seconds of the mixing period. The throat of the drum shall be kept free of such accumulations as may restrict the free flow of materials into the drum.

Mixed concrete from the central mixing plant shall be transported in truck mixers, truck agitators or non-agitating truck specified in Subsection 311.3.2, Equipment. The time elapsed from the time water is added to the mix until the concrete is deposited in place at the Site shall not exceed forty five (45) minutes when the concrete is hauled in non-agitating trucks, nor ninety (90) minutes when hauled in truck mixers or truck agitators, except that in hot weather or under other conditions contributing to quick hardening of the concrete, the maximum allowable time may be reduced by the Engineer.

In exceptional cases and when volumetric measurements are authorized for small project requiring less than 75 cu.m. of concrete per day of pouring, the weight proportions shall be converted to equivalent volumetric proportions. In such cases, suitable allowance shall be made for variations in the moisture condition of the aggregates, including the bulking effect in the fine aggregate. Batching and mixing shall be in accordance with ASTM C 685, Section 6 through 9.

Concrete mixing by chute is allowed provided that a weighing scales for determining the batch weight will be used.

Retempering concrete by adding water or by other means shall not be permitted, except that when concrete is delivered in truck mixers, additional water may be added to the batch materials and additional mixing performed to increase the slump to meet the specified requirements, if permitted by the Engineer, provided all these operations are performed within forty-five (45) minutes after the initial mixing operation and the water-cement ratio is not exceeded. Concrete that is not within the specified slump limits at the time of placement shall not be used. Admixtures for increasing the workability or for accelerating the setting of the concrete will be permitted only when specifically approved by the Engineer.

311.3.8 Limitation of Mixing

No concrete shall be mixed, placed or finished when natural light is insufficient, unless an adequate and approved artificial lighting system is operated.

During hot weather, the Engineer shall require that steps be taken to prevent the temperature of mixed concrete from exceeding a maximum temperature of 90⁰F (32⁰C)

Concrete not in place within ninety (90) minutes from the time the ingredients were charged into the mixing drum or that has developed initial set shall not be used. Retempering of concrete or mortar which has partially hardened, that is remixing with or without additional cement, aggregate, or water, shall not be permitted.

In order that the concrete may be properly protected against the effects of rain before the concrete is sufficiently hardened, the Contractor will be required to have available at all times materials for the protection of the edges and surface of the unhardened concrete.

311.3.9 Placing Concrete

Concrete shall be deposited in such a manner to require minimal rehandling. Unless truck mixers or non-agitating hauling equipment are equipped with means to discharge concrete without segregation of the materials, the concrete shall be unloaded into an approved spreading device and mechanically spread on the grade in such a manner as to prevent segregation. Placing shall be continuous between transverse joints without the use of intermediate bulkheads. Necessary hand spreading shall be done with shovels, not rakes. Workmen shall not be allowed to walk in the freshly mixed concrete with boots or shoes coated with earth or foreign substances.

When concrete is to be placed adjoining a previously constructed lane and mechanical equipment will be operated upon the existing lane, that previously constructed lane shall have attained the strength for fourteen (14) day concrete. If only finishing equipment is carried on the existing lane, paving in adjoining lanes may be permitted after three (3) days.

Concrete shall be thoroughly consolidated against and along the faces of all forms and along the full length and on both sides of all joint assemblies, by means of vibrators inserted in the concrete. Vibrators shall not be permitted to come in contact with a joint assembly, the grade, or a side form. In no case shall the vibrator be operated longer than fifteen (15) seconds in any one location.

Concrete shall be deposited as near as possible to the expansion and contraction joints without disturbing them, but shall not be dumped from the discharge bucket or hopper into a joint assembly unless the hopper is well centered on the joint assembly. Should any concrete material fall on or be worked into the surface of a complete slab, it shall be removed immediately.

311.3.10 Test Specimens

As work progresses, at least one (1) set consisting of three (3) concrete beam test specimens, 150 mm x 150 mm x 525 mm or 900 mm shall be taken from each 330 m² of pavement, 230 mm depth, or fraction thereof placed each day. Test specimens shall be made under the supervision of the Engineer, and the Contractor shall provide all concrete and other facilities necessary in making the test specimens and shall protect them from damage by construction operations. Cylinder samples shall not be used as substitute for determining the adequacy of the strength of concrete.

The beams shall be made, cured, and tested in accordance with AASHTO T 23 and T 97.

311.3.11 Strike-off of Concrete and Placement of Reinforcement

Following the placing of the concrete, it shall be struck off to conform to the cross-section shown on the Plans and to an elevation such that when the concrete is properly consolidated and finished, the surface of the pavement will be at the elevation shown on the Plans. When reinforced concrete pavement is placed in two (2) layers, the bottom layer shall be struck off and consolidated to such length and depth that the sheet of fabric or bar mat may be laid full length on the concrete in its final position without further manipulation. The reinforcement shall then be placed directly upon the concrete, after which the top layer of the concrete shall be placed, struck off and screeded. Any portion of the bottom layer of concrete which has been placed more than 30 minutes without being covered with the top layer shall be removed and replaced with freshly mixed concrete at the Contractor's expense. When reinforced concrete is placed in one layer, the reinforcement may be firmly positioned in advance of concrete placement or it may be placed at the depth shown on the Plans in plastic concrete, after spreading by mechanical or vibratory means.

Reinforcing steel shall be free from dirt, oil, paint, grease, mill scale and loose or thick rust which could impair bond of the steel with the concrete.

311.3.12 Joints

Joints shall be constructed of the type and dimensions, and at the locations required by the Plans or Special Provisions. All joints shall be protected from the intrusion of injurious foreign material until sealed.

1. Longitudinal Joint

Deformed steel tie bars of specified length, size, spacing and materials shall be placed perpendicular to the longitudinal joints, they shall be placed by approved mechanical equipment or rigidly secured by chair or other approved supports to prevent displacement. Tie bars shall not be painted or coated with asphalt or other materials or enclosed in tubes or sleeves. When shown on the Plans and when adjacent lanes of pavement are constructed separately, steel side forms shall be used which will form a keyway along the construction joint. Tie bars, except those made of rail steel, may be bent at right angles against the form of the first lane constructed and straightened into final position before the concrete of the adjacent lane is placed, or in lieu of bent tie bars, approved two-piece connectors may be used.

Longitudinal formed joints shall consist of a groove or cleft, extending downward from and normal to, the surface of the pavement. These joints shall be effected or formed by an approved mechanically or manually operated device to the dimensions and line indicated on the Plans and while the concrete is in a plastic state. The groove or cleft shall be filled with either a premolded strip or poured material as required.

The longitudinal joints shall be continuous, there shall be no gaps in either transverse or longitudinal joints at the intersection of the joints.

Longitudinal sawed joints shall be cut by means of approved concrete saws to the depth, width and line shown on the Plans. Suitable guide lines or devices shall be used to assure cutting the longitudinal joint on the true line. The longitudinal joint shall be sawed before the end of the curing period or shortly thereafter and before any equipment or vehicles are allowed on the pavement. The sawed area shall be thoroughly cleaned and, if required, the joint shall immediately be filled with sealer.

Longitudinal pavement insert type joints shall be formed by placing a continuous strip of plastic materials which will not react adversely with the chemical constituent of the concrete.

2. Transverse Expansion Joint

The expansion joint filler shall be continuous from form to form, shaped to subgrade and to the keyway along the form. Preformed joint filler shall be furnished in lengths equal to the pavement width or equal to the width of one lane. Damaged or repaired joint filler shall not be used.

The expansion joint filler shall be held in a vertical position. An approved installing bar, or other device, shall be used if required to secure preformed expansion joint filler at the proper grade and alignment during placing and finishing of the concrete. Finished joint shall not deviate more than 6 mm from a straight line. If joint fillers are assembled in sections, there shall be no offsets between adjacent units. No plugs of concrete shall be permitted anywhere within the expansion space.

3. Transverse Contraction Joint/Weakened Joint

When shown on the Plans, it shall consist of planes of weakness created by forming or cutting grooves in the surface of the pavement and shall include load transfer assemblies. The depth of the weakened plane joint should at all times not be less than 50 mm, while the width should not be more than 6 mm.

- a. Transverse Strip Contraction Joint. It shall be formed by installing a parting strip to be left in place as shown on the Plans.
- b. Formed Groove. It shall be made by depressing an approved tool or device into the plastic concrete. The tool or device shall remain in place at least until the concrete has attained its initial set and shall then be removed without disturbing the adjacent concrete, unless the device is designed to remain in the joint.
- c. Sawed Contraction Joint. It shall be created by sawing grooves in the surface of the pavement of the width not more than 6 mm, depth should at all times not be less than 50 mm, and at the spacing and lines shown on the Plans, with an approved concrete saw. After each joint is sawed, it shall be thoroughly cleaned including the adjacent concrete surface.

Sawing of the joint shall commence as soon as the concrete has hardened sufficiently to permit sawing without excessive ravelling, usually 4 to 24 hours. All joints shall be sawed before uncontrolled shrinkage cracking takes place. If necessary, the sawing operations shall be carried on during the day or night, regardless of weather conditions. The sawing of any joint shall be omitted if crack occurs at or near the joint location prior to the time of sawing. Sawing shall be discontinued when a crack develops ahead of the saw. In general, all joints should be sawed in sequence. If extreme condition exist which make it impractical to prevent erratic cracking by early sawing, the contraction joint groove shall be formed prior to initial set of concrete as provided above.

4. Transverse Construction Joint

It shall be constructed when there is an interruption of more than 30 minutes in the concreting operations. No transverse joint shall be constructed within 1.50 m of an expansion joint, contraction joint, or plane of weakness. If sufficient concrete has been mixed at the time of interruption to form a slab of at least 1.5 m long, the excess concrete from the last preceding joint shall be removed and disposed off as directed.

5. Load Transfer Device

Dowel, when used, shall be held in position parallel to the surface and center line of the slab by a metal device that is left in the pavement.

The portion of each dowel painted with one coat of lead or tar, in conformance with the requirements of Item 404, Reinforcing Steel, shall be thoroughly coated with approved bituminous materials, e.g., MC-70, or an approved lubricant, to prevent the concrete from binding to that portion of the dowel. The sleeves for dowels shall be metal designed to cover 50 mm plus or minus 5 mm (1/4 inch), of the dowel, with a watertight closed end and with a suitable stop to hold the end of the sleeves at least 25 mm (1 inch) from the end of the dowel.

In lieu of using dowel assemblies at contraction joints, dowel may be placed in the full thickness of pavement by a mechanical device approved by the Engineer.

311.3.13 Final Strike-off (Consolidation and Finishing)

1. Sequence

The sequence of operations shall be the strike-off and consolidation, floating and removal of laitance, straight-edging and final surface finish. Work bridges or other devices necessary to provide access to the pavement surface for the purpose of finishing straight-edging, and make corrections as hereinafter specified, shall be provided by the Contractor.

In general, the addition of water to the surface of the concrete to assist in finishing operations will not be permitted. If the application of water to the surface is permitted, it shall be applied as fog spray by means of an approved spray equipment.

2. Finishing Joints

The concrete adjacent to joints shall be compacted or firmly placed without voids or segregation against the joint material assembly, also under and around all load transfer devices, joint assembly units, and other features designed to extend into the pavement. Concrete adjacent to joints shall be mechanically vibrated as required in Subsection 311.3.9, Placing Concrete.

After the concrete has been placed and vibrated adjacent to the joints as required in Subsection 311.3.9, the finishing machine shall be brought forward, operating in a manner to avoid damage or misalignment of joints. If uninterrupted operation of the finishing machine, to over and beyond the joints causes segregation of concrete, damage to, or misalignment of the joints, the finishing machine shall be stopped when the front screed is approximately 20 cm (8 inches) from the joint. Segregated concrete shall be removed from in front of and off the joint. The front screed shall be lifted and set directly on top of the joint and the forward motion of the finishing machine resumed. When the second screed is close enough to permit the excess mortar in front of it to flow over the joint, it shall be lifted and carried over the joint. Thereafter, the finishing machine may be run over the joint without lifting the screeds, provided there is no segregated concrete immediately between the joint and the screed or on top of the joint.

3. Machine Finishing

a. Non-vibratory Method. The concrete shall be distributed or spread as soon as placed. As soon as the concrete has been placed, it shall be struck off and screeded by an approved finishing machine. The machine shall go over each area of pavement as many times and at such intervals as necessary to give the proper compaction and leave a surface of uniform texture. Excessive operation over a given area shall be avoided. The tops of the forms shall be kept clean by an effective device attached to the machine and the travel of the machine on the forms shall be maintained true without wobbling or other variation tending to affect the precision finish.

During the first pass of the finishing machine, a uniform ridge of concrete shall be maintained ahead of the front screed in its entire length.

b. Vibratory Method. When vibration is specified, vibrators for full width vibration of concrete paving slabs, shall meet the requirements in Subsection 311.3.2, Equipment. If uniform and satisfactory density of the concrete is not obtained by the vibratory method at joints, along forms, at structures, and throughout the pavement, the Contractor will be required to furnish equipment and method which will produce pavement conforming to the Specifications. All provisions in item (a) above not in conflict with the provisions for the vibratory method shall govern.

4. Hand Finishing

Hand finishing methods may only be used under the following conditions:

a. In the event of breakdown of the mechanical equipment, hand methods may be used to finish the concrete already deposited on the grade.

b. In narrow widths or areas of irregular dimensions where operations of the mechanical equipment is impractical, hand methods may be used.

Concrete, as soon as placed, shall be struck off and screeded. An approved portable screed shall be used. A second screed shall be provided for striking off the bottom layer of concrete if reinforcement is used.

The screed for the surface shall be at least 60 cm (2 feet) longer than the maximum width of the slab to be struck off. It shall be of approved design, sufficiently rigid to retain its shape, and constructed either of metal or other suitable material shod with metal.

Consolidation shall be attained by the use of suitable vibrator or other approved equipment.

In operation, the screed shall be moved forward on the forms with a combined longitudinal and transverse shearing motion, moving always in the direction in which the work is progressing and so manipulated that neither end is raised from the side forms during the striking off process. If necessary, this shall be repeated until the surface is of uniform texture, true to grade and cross-section, and free from porous areas.

5. Floating

After the concrete has been struck off and consolidated, it shall be further smoothed, trued, and consolidated by means of a longitudinal float, either by hand or mechanical method.

a. Hand Method. The hand-operated longitudinal float shall be not less than 365 cm (12 feet) in length and 15 cm (6 inches) in width, properly stiffened to prevent flexibility and warping. The longitudinal float, operated from foot bridges resting on the side forms and spanning but not touching the concrete, shall be worked with a sawing motion while held in a floating position parallel to the road center line, and moving gradually from one side of the pavement to the other. Movement ahead along the center line of the pavement shall be in successive advances of not more than one-half the length of the float. Any excess water or soupy material shall be wasted over the side forms on each pass.

b. Mechanical Method. The mechanical longitudinal float shall be of a design approved by the Engineer, and shall be in good working condition. The tracks from which the float operates shall be accurately adjusted to the required crown. The float shall be accurately adjusted and coordinated with the adjustment of the transverse finishing machine so that a small amount of mortar is carried ahead of the float at all times. The forward screed shall be adjusted so that the float will lap the distance specified by the Engineer on each transverse trip. The float shall pass over each areas of pavement at least two times, but excessive operation over a given area will not be permitted. Any excess water or soupy material shall be wasted over the side forms on each pass.

c. Alternative Mechanical Method. As an alternative, the Contractor may use a machine composed of a cutting and smoothing float or floats suspended from and guided by a rigid frame. The frame shall be carried by four or more visible wheels riding on, and constantly in contact with the side forms. If necessary, following one of the preceding method of floating, long handled floats having blades not less than 150 cm (5 feet) in length and 15 cm (6 inches) in width may be used to smooth and fill in open-textured areas in the pavement. Long-handled floats shall not be used to float the entire surface of the pavement in lieu of, or supplementing, one of the preceding methods of floating. When strike off and consolidation are done by the hand method and the crown of the pavement will not permit the use of the longitudinal float, the surface shall be floated transversely by means of the long-handled float. Care shall be taken not to work the crown out of the pavement during the operation. After floating, any excess water and laitance shall be removed from the surface of the pavement by a 3-m straight- edge or more in length. Successive drags shall be lapped one-half the length of the blade.

6. Straight-edge Testing and Surface Correction

After the floating has been completed and the excess water removed, but while the concrete is still plastic, the surface of the concrete shall be tested for trueness with a 300 cm long straight-edge. For this purpose, the Contractor shall furnish and use an accurate 300-cm straight-edge swung from handles 100 cm (3 feet) longer than one-half the width of the slab. The straight-edge shall be held in contact with the surface in successive positions parallel to the road center line and the whole area gone over from one side of the slab to the other as necessary. Advances along the road shall be in successive stages of not more than one-half the length of the straight-

edge. Any depressions found shall be immediately filled with freshly mixed concrete, struck off, consolidated and refinished. High areas shall be cut down and refinished. Special attention shall be given to assure that the surface across joints meets the requirements for smoothness. Straight-edge testing and surface corrections shall continue until the entire surface is found to be free from observable departures from the straight-edge and the slab conforms to the required grade and cross-section.

7. Final Finish

If the surface texture is broom finished, it shall be applied when the water sheen has practically disappeared. The broom shall be drawn from the center to the edge of the pavement with adjacent strokes slightly overlapping. The brooming operation should be so executed that the corrugations produced in the surface shall be uniform in appearance and not more than 1.5 mm in depth. Brooming shall be completed before the concrete is in such condition that the surface will be unduly roughened by the operation. The surface thus finished shall be free from rough and porous areas, irregularities, and depressions resulting from improper handling of the broom. Brooms shall be of the quality size and construction and be operated so as to produce a surface finish meeting the approval of the Engineer. Subject to satisfactory results being obtained and approval of the Engineer, the Contractor will be permitted to substitute mechanical brooming in lieu of the manual brooming herein described.

If the surface texture is belt finished, when straight-edging is complete and water sheen has practically disappeared and just before the concrete becomes non-plastic, the surface shall be belted with 2-ply canvas belt not less than 20 cm wide and at least 100 cm longer than the pavement width. Hand belts shall have suitable handles to permit controlled, uniform manipulation. The belt shall be operated with short strokes transverse to the center line and with a rapid advance parallel to the center line.

If the surface texture is drag finished, a drag shall be used which consists of a seamless strip of damp burlap or cotton fabric, which shall produce a uniform gritty texture after dragging it longitudinally along the full width of pavement. For pavement 5 m or more in width, the drag shall be mounted on a bridge which travels on the forms. The dimensions of the drag shall be such that a strip of burlap or fabric at least 100 cm wide is in contact with the full width of pavement surface while the drag is used. The drag shall consist of not less than 2 layers of burlap with the bottom layer approximately 15 cm wider than the layer. The drag shall be maintained in such condition that the resultant surface is of uniform appearance and reasonably free from grooves over 1.5 mm in depth. Drag shall be maintained clean and free from encrusted mortar. Drags that cannot be cleaned shall be discarded and new drags be substituted.

Regardless of the method used for final finish, the hardened surface of pavement shall have a coefficient of friction of 0.25 or more. Completed pavement that is found to have a coefficient of friction less than 0.25 shall be ground or scored by the Contractor at his expense to provide the required coefficient of friction.

8. Edging at Forms and Joints

After the final finish, but before the concrete has taken its initial set, the edges of the pavement along each side of each slab, and on each side of transverse expansion joints, formed joints, transverse construction joints, and emergency construction joints, shall be worked with an approved tool and rounded to the radius required by the Plans. A well – defined and

continuous radius shall be produced and a smooth, dense mortar finish obtained. The surface of the slab shall not be unduly disturbed by tilting the tool during the use.

At all joints, any tool marks appearing on the slab adjacent to the joints shall be eliminated by brooming the surface. In doing this, the rounding of the corner of the slab shall not be disturbed. All concrete on top of the joint filler shall be completely removed.

All joints shall be tested with a straight-edge before the concrete has set and correction made if one edge of the joint is higher than the other.

311.3.14 Surface Test

As soon as the concrete has hardened sufficiently, the pavement surface shall be tested with a 3-m straight-edge or other specified device. Areas showing high spots of more than 3 mm but not exceeding 12 mm in 3 m shall be marked and immediately ground down with an approved grinding tool to an elevation where the area or spot will not show surface deviations in excess of 3 mm when tested with 3 m straight-edge. Where the departure from correct cross-section exceeds 12 mm, the pavement shall be removed and replaced by and at the expense of the Contractor.

Any area or section so removed shall be not less than 1.5 m in length and not less than the full width of the lane involved. When it is necessary to remove and replace a section of pavement, any remaining portion of the slab adjacent to the joints that is less than 1.5 m in length, shall also be removed and replaced.

311.3.15 Curing

Immediately after the finishing operations have been completed and the concrete has sufficiently set, the entire surface of the newly placed concrete shall be cured in accordance with either one of the methods described herein. Failure to provide sufficient cover material of whatever kind the Contractor may elect to use, or the lack of water to adequately take care of both curing and other requirements, shall be a cause for immediate suspension of concreting operations. The concrete shall not be left exposed for more than ½ hour between stages of curing or during the curing period.

In all congested places, concrete works should be designed so that the designed strength is attained.

1. Cotton of Burlap Mats

The surface of the pavement shall be entirely covered with mats. The mats used shall be of such length (or width) that as laid they will extend at least twice the thickness of the pavement beyond the edges of the slab. The mat shall be placed so that the entire surface and the edges of the slab are completely covered. Prior to being placed, the mats shall be saturated thoroughly with water. The mat shall be so placed and weighted down so as to cause them to remain in intimate contact with the covered surface. The mat shall be maintained fully wetted and in position for 72 hours after the concrete has been placed unless otherwise specified.

2. Waterproof Paper

The top surface and sides of the pavement shall be entirely covered with waterproof paper, the units shall be lapped at least 45 cm. The paper shall be so placed and weighted down so as to cause it to remain in intimate contact with the surface covered. The paper shall have such dimension but each unit as laid will extend beyond the edges of the slab at least twice the thickness of the pavement, or at pavement width and 60 cm strips of paper for the edges. If laid longitudinally, paper not manufactured in sizes which will provide this width shall be securely sewed or cemented together, the joints being securely sealed in such a manner that they do not open up or separate during the curing period. Unless otherwise specified, the covering shall be maintained in place for 72 hours after the concrete has been placed. The surface of the pavement shall be thoroughly wetted prior to the placing of the paper.

3. Straw Curing

When this type of curing is used, the pavement shall be cured initially with burlap or cotton mats, until after final set of the concrete or, in any case, for 12 hours after placing the concrete. As soon as the mats are removed, the surface and sides of the pavement shall be thoroughly wetted and covered with at least 20 cm of straw or hay, thickness of which is to be measured after wetting. If the straw or hay covering becomes displaced during the curing period, it shall be replaced to the original depth and saturated. It shall be kept thoroughly saturated with water for 72 hours and thoroughly wetted down during the morning of the fourth day, and the cover shall remain in place until the concrete has attained the required strength.

4. Impervious Membrane Method

The entire surface of the pavement shall be sprayed uniformly with white pigmented curing compound immediately after the finishing of the surface and before the set of the concrete has taken place, or if the pavement is cured initially with jute or cotton mats, it may be applied upon removal of the mass. The curing compound shall not be applied during rain.

Curing compound shall be applied under pressure at the rate 4 L to not more than 14 m² by mechanical sprayers. The spraying equipment shall be equipped with a wind guard. At the time of use, the compound shall be in a thoroughly mixed condition with the pigment uniformly dispersed throughout the vehicle. During application, the compound shall be stirred continuously by effective mechanical means. Hand spraying of odd widths or shapes and concrete surface exposed by the removal of forms will be permitted. Curing compound shall not be applied to the inside faces of joints to be sealed, but approved means shall be used to insure proper curing at least 72 hours and to prevent the intrusion of foreign material into the joint before sealing has been completed. The curing compound shall be of such character that the film will harden within 30 minutes after application. Should the film be damaged from any cause within the 72 hour curing period, the damaged portions shall be repaired immediately with additional compound.

5. White Polyethylene Sheet

The top surface and sides of the pavement shall be entirely covered with polyethylene sheeting. The units used shall be lapped at least 45 cm. The sheeting shall be so placed and weighted down so as to cause it to remain intimate contact with the surface covered. The sheeting as prepared for use shall have such dimension that each unit as laid will extend beyond the edges of the slab at least twice the thickness of the pavement. Unless otherwise specified, the covering shall be maintained in place for 72 hours after the concrete has been placed.

311.3.16 Removal of Forms

After forms for concrete shall remain in place undisturbed for not less than twenty four (24) hours after concrete pouring. In the removal of forms, crowbars should be used in pulling out nails and pins. Care should be taken so as not to break the edges of the pavement. In case portions of the concrete are spalled, they shall be immediately repaired with fresh mortar mixed in the proportion of one part of Portland Cement and two parts fine aggregates. Major honeycomb areas will be considered as defective work and shall be removed and replaced at the expense of the Contractor. Any area or section so removed shall not be less than the distance between weakened plane joint nor less than the full width of the lane involved.

311.3.17 Sealing Joints

Joints shall be sealed with asphalt sealant soon after completion of the curing period and before the pavement is opened to traffic, including the Contractor's equipment. Just prior to sealing, each joint shall be thoroughly cleaned of all foreign materials including membrane curing compound and the joint faces shall be clean and surface dry when the seal is applied.

The sealing material shall be applied to each joint opening to conform to the details shown on the Plans or as directed by the Engineer. Material for seal applied hot shall be stirred during heating so that localized overheating does not occur. The pouring shall be done in such a manner that the material will not be spilled on the exposed surfaces of the concrete. The use of sand or similar material as a cover for the seal will not be permitted.

Preformed elastomeric gaskets for sealing joints shall be of the cross-sectional dimensions shown on the Plans. Seals shall be installed by suitable tools, without elongation and secured in place with an approved lubricant adhesive which shall cover both sides of the concrete joints. The seals shall be installed in a compressive condition and shall at time of placement be below the level of the pavement surface by approximately 6 mm.

The seals shall be in one piece for the full width of each transverse joint.

311.3.18 Protection of Pavement

The Contractor shall protect the pavement and its appurtenances against both public traffic and traffic caused by his own employees and agents. This shall include watchmen to direct traffic and the erection of and maintenance of warning signs, lights, pavement bridges or cross-overs, etc. The Plans or Special Provisions will indicate the location and type of device or facility required to protect the work and provide adequately for traffic.

All boreholes after thickness and/or strength determinations of newly constructed asphalt and concrete pavements shall be immediately filled/restored with the prescribed concrete/asphalt mix after completion of the drilling works.

Any damage to the pavement, occurring prior to final acceptance, shall be repaired or the pavement be replaced.

311.3.19 Concrete Pavement – Slip Form Method

If the Contract calls for the construction of pavement without the use of fixed forms, the following provisions shall apply:

1. Grade

After the grade or base has been placed and compacted to the required density, the areas which will support the paving machine shall be cut to the proper elevation by means of a properly designed machine. The grade on which the pavement is to be constructed shall then be brought to the proper profile by means of properly designed machine. If the density of the base is disturbed by the grading operation, it shall be corrected by additional compaction before concrete is placed. The grade should be constructed sufficiently in advance of the placing of the concrete. If any traffic is allowed to use the prepared grade, the grade shall be checked and corrected immediately before the placing of concrete.

2. Placing Concrete

The concrete shall be placed with an approved slip-form paver designed to spread, consolidate, screed and float-finish the freshly placed concrete in one complete pass of the machine in such a manner that a minimum of hand finish will be necessary to provide a dense and homogenous pavement in conformance with the Plans and Specifications. The machine shall vibrate the concrete for the full width and depth of the strip of pavement being placed. Such vibration shall be accompanied with vibrating tubes or arms working in the concrete or with a vibrating screed or pan operating on the surface of the concrete. The sliding forms shall be rigidly held together laterally to prevent spreading of the forms. The forms shall trail behind the paver for such a distance that no appreciable slumping of the concrete will occur, and that necessary final finishing can be accomplished while the concrete is still within the forms. Any edge slump of the pavement, exclusive of edge rounding, in excess of 6 mm shall be corrected before the concrete has hardened.

The concrete shall be held at a uniform consistency, having a slump of not more than 40 mm (1-12/ inches). The slip form paver shall be operated with as nearly as possible a continuous forward movement and that all operations of mixing, delivering and spreading concrete shall be coordinated so as to provide uniform progress with stopping and starting of the paver held to a minimum. If, for any reason, it is necessary to stop the forward movement of the paver the vibratory and tamping elements shall also be stopped immediately. No tractive force shall be applied to the machine, except that which is controlled from the machine.

3. Finishing

The surface smoothness and texture shall meet the requirements of Subsections 311.3.13

and 311.3.14.

4. Curing

Unless otherwise specified, curing shall be done in accordance with one of the methods included in Subsection 311.3.15. The curing media shall be applied at the appropriate time and shall be applied uniformly and completely to all surfaces and edges of the pavement.

5. Joints

All joints shall be constructed in accordance with Subsection 311.3.12.

6. Protection Against Rain

In order that the concrete may be properly protected against rain before the concrete is sufficiently hardened, the Contractor will be required to have available at all times, materials for the protection of the edges and surface of the unhardened concrete. Such protective materials shall consist of standard metal forms or wood planks having a nominal thickness of not less than 50 mm (2 inches) and a nominal width of not less than the thickness of the pavement at its edge for the protection of the pavement edges, and covering material such as burlap or cotton mats, curing paper or plastic sheeting materials for the protection of the surface of the pavement. When rain appears imminent, all paving operations shall stop and all available personnel shall begin placing forms against the sides of the pavement and covering the surface of the unhardened concrete with the protective covering.

311.3.22 Acceptance of Concrete

The strength level of the concrete will be considered satisfactory if the averages of all sets of three (3) consecutive strength test results equal or exceed the specified strength, f_c' and no individual strength test result is deficient by more than 15% of the specified strength, f_c' .

Concrete deemed to be not acceptable using the above criteria may be rejected unless the Contractor can provide evidence, by means of core tests, that the quality of concrete represented by failed test results is acceptable in place. At least three (3) representative cores shall be taken from each member or area of concrete in place that is considered deficient. The location of cores shall be determined by the Engineer so that there will be at least impairment of strength of the structure. The obtaining and testing of drilled cores shall be in accordance with AASHTO T 24.

Concrete in the area represented by the cores will be considered adequate if the average strength of the cores is equal to at least 85% of, and if no single core is less than 75% of, the specified strength, f_c' .

If the strength of control specimens does not meet the requirements of this Subsection, and it is not feasible or not advisable to obtain cores from the structure due to structural considerations, payment of the concrete will be made at an adjusted price due to strength

deficiency of concrete specimens as specified hereunder:

Deficiency in Strength of Concrete Specimens, Percent (%)	Percent (%) of Contract Price Allowed
Less than 5	100
5 to less than 10	80
10 to less than 15	70
15 to less than 20	60
20 to less than 25	50
25 or more	0

311.3.23 Opening to Traffic

The Engineer will decide when the pavement may be opened to traffic. The road will not be opened to traffic until test specimens molded and cured in accordance with AASHTO T 23 have attained the minimum strength requirements in Subsection 311.2.11. If such tests are not conducted prior to the specified age the pavement shall not be operated to traffic until 14 days after the concrete was placed. Before opening to traffic, the pavement shall be cleaned and joint sealing completed.

Tolerance and Pavement thickness

1. General

The thickness of the pavement will be determined by measurement of cores from the completed pavement in accordance with AASHTO T 148.

The completed pavement shall be accepted on a lot basis. A lot shall be considered as 1000 linear meters of pavement when a single traffic lane is poured or 500 linear meters when two lanes are poured concurrently. The last unit in each slab constitutes a lot in itself when its length is at least ½ of the normal lot length. If the length of the last unit is shorter than ½ of the normal lot length, it shall be included in the previous lot.

Other areas such as intersections, entrances, crossovers, ramp, etc., will be grouped together to form a lot. Small irregular areas may be included with other unit areas to form a lot.

Each lot will be divided into five (5) equal segments and one core will be obtained from each segment in accordance with AASHTO T 24.

2. Pavement Thickness

It is the intent of this Specification that the pavement has a uniform thickness as called for on the Plans for the average of each lot as defined. After the pavement has met all surface smoothness requirements, cores for thickness measurements will be taken.

In calculating the average thickness of the pavement, individual measurements which are in excess of the specified thickness by more than 5 mm will be considered as the specified thickness plus 5 mm and measurement which are less than the specified thickness by more than 25 mm shall not be included in the average. When the average thickness for the lot is deficient, the contract unit price will be adjusted for thickness in accordance with paragraph (3 below).

Individual areas within a segment found deficient in thickness by more than 25 mm shall be evaluated by the Engineer, and if in his judgment, the deficient areas warrant removal, they shall be removed and replaced by the Contractor with pavement of the specified thickness at his entire expense. However, if the evaluation of the Engineer is that the deficient area should not be removed and replaced, such area will not be paid.

When the measurement of any core is less than the specified thickness by more than 25 mm, the actual thickness of the pavement in this area will be determined by taking additional cores at no less than 5 m intervals parallel to the center line in each direction from the affected location until a core is found in each direction, which is not deficient in thickness by more than 25 mm. The area of slab for which no payment will be made shall be the product of the paving width multiplied by the distance along the center line of the road between transverse sections found not deficient in thickness by more than 25 mm. The thickness of the remainder of the segment to be used to get the average thickness of each lot shall be determined by taking the average thickness of additional cores which are not deficient by more than 25 mm.

3. Adjustment for Thickness

When the average thickness of the pavement per lot is deficient, payment for the lot shall be adjusted as follows:

Deficiency in the Average Thickness per lot (mm)	Percent (%) of Contract Price Per Lot
0 – 5	100% payment

6 – 10	95% payment
11 – 15	85% payment

16 – 20	70% payment
21 – 25	50% payment
More than 25	Remove and replace/ No payment

No acceptance and final payment shall be made on completed pavement unless core test for thickness determination is conducted, except for Barangay Roads where the implementing office is allowed to waive such test.

311.4 Method of Measurement

The area to be paid for under this Item shall be the number of square meters (m²) of concrete pavement placed and accepted in the completed pavement. The width for measurements will be the width from outside edge to outside edge of completed pavement as placed in accordance with the Plans or as otherwise required by the Engineer in writing. The length will be measured horizontally along the center line of each roadway or ramp. Any curb and gutter placed shall not be included in the area of concrete pavement measured.

311.5 Basis of Payment

The accepted quantity, measured as prescribed in Section 311.4, shall be paid for at the contract unit price for Portland Cement Concrete Pavement, which price and payment shall be full compensation for preparation of roadbed and finishing of shoulders, unless otherwise provided by the Special Provisions, furnishing all materials, for mixing, placing, finishing and curing all concrete, for furnishing and placing all joint materials, for sawing weakened plane joints, for fitting the prefabricated center metal joint, for facilitating and controlling traffic, and for furnishing all labor, equipment, tools and incidentals necessary to complete the Item.

Payment will be made under:

Pay Item Number	Description	Unit of Measurement
311 (1)	PCC Pavement (Plain)	Square meter
311 (2)	PCC Pavement (Reinforced)	Square meter

ITEM 506 STONE MASONRY

506.1 Description

This Item shall consist of stone masonry in minor structures, in headwall for culverts, in retaining walls at the toes of slope, and at other places called for on the plans, constructed on the prepared foundation bed, in accordance with this Specification and to the lines, grades and dimensions shown on the Drawings. This work also includes construction of weep holes.

506.2 Material Requirements

506.2.1 Stone

Stones shall be clean, hard and durable and shall be subject to the approval of the Engineer. Unless otherwise specified on the Drawings or as directed by the Engineer, stones for masonry shall be Class A as described in Item 504, Riprap and Grouted Riprap. Stones shall have roughly similar blunted ends.

506.2.2 Mortar

The mortar for stone masonry shall be composed of one (1) part Portland cement to two (2) parts of sand by volume and sufficient water to obtain the required consistency and shall conform to the requirements of materials under Item 405, Structural Concrete.

506.3 Construction Requirement

506.3.1 Selection and Placing

Care shall be taken to prevent the bunching of small stone or stones of the same size. Large stones shall be used in the corners. All stones shall be cleaned thoroughly and wetted immediately before being set, and the bed shall be cleaned and moistened before the mortar is spread. They shall be laid with their longest faces horizontal in full beds of mortar, and the joint shall be flushed with mortar.

506.3.2 Weepholes

It shall conform to the requirement of item 504, Riprap and Grouted Riprap.

506.3.3 Cleaning Exposed Faces

Immediately after being laid, all outside face stone shall be thoroughly cleaned of mortar stains and shall be kept clean until the work is completed.

506.4 Method of Measurement

Stone Masonry shall be measured by the number of cubic meter in place, completed and accepted by the Engineer in accordance with the Drawings. Only accepted work will be measured for payment and the computation of the quantity thereof will be based on the volume within the limiting dimensions designated on the Drawings or as determined by the Engineer. No separate measurement shall be made for filter materials.

506.5 Basis of Payment

The quantities measured as provided under Sub-Section 506.4, Method of Measurement shall be paid for at the Contract unit price as listed in the Bill of Quantities, which price and payment shall be full compensation for excavation and preparation of the bed, for furnishing and placing all materials including weep holes, filter

materials, backfill, and additional fill to bring the riprap bed to the line, grades and dimension as shown on the Drawings and for all labor, equipment, tools and incidentals necessary to complete the work Item.

Payment will be made under:

Pay Item Number	Description	Unit of Measurement
506(1)	Stone Masonry	Cubic Meter

Section VII. Drawings

Republic of the Philippines
Province of Camarines Norte
Daet

DETAILED ENGINEERING DESIGN

CONSTRUCTION OF FARM TO MARKET ROAD

Brgy. Cobangbang, Daet Camarines Norte

Concreting: Sta. 0+000.00 - Sta. 0+312.50

**Net Length : Concreting of 312.50 lm x 4.00m x 0.20m road
and 195.39cu.m. Stone Masonry**



PROVINCE OF CAMARINES NORTE
 OFFICE OF THE
 PROVINCIAL ENGINEER
 DEL P. CAMARINES NORTE

PROJECT TITLE:
**CONSTRUCTION OF FARM TO
 MARKET ROAD**
 Brgy. Calangpang, Dkt. Camarines Norte

PREPARED BY:
ANGELAP B. BAGAY
 MARY JAY BELEN

CHECKED & SUBMITTED BY:
SAMUEL T. YANTO

REVIEWED & VERIFIED BY:
FLORDELIZ B. ALER

RECOMMENDING APPROVAL:
JOHN MARTIN S. TORIAS

APPROVED BY:
JOSEPH V. ASCUTIA
 Acting Provincial Engineer

SHEET NO. 1 / 5

MAP OF CAMARINES NORTE

- SUBDIVISION - NATIONAL ROAD
- SECURITIZED NATIONAL ROAD
- MUNICIPAL ROAD
- MUNICIPAL EXTENSION ROAD
- UNIMPROVED ROADS
- TO ALL INTERMUNICIPAL BOUNDARIES

- LEGEND:
- NATIONAL HIGHWAY - NATIONAL ROAD
 - SECURITIZED NATIONAL ROAD
 - MUNICIPAL ROAD
 - MUNICIPAL EXTENSION ROAD
 - UNIMPROVED ROADS
 - TO ALL INTERMUNICIPAL BOUNDARIES

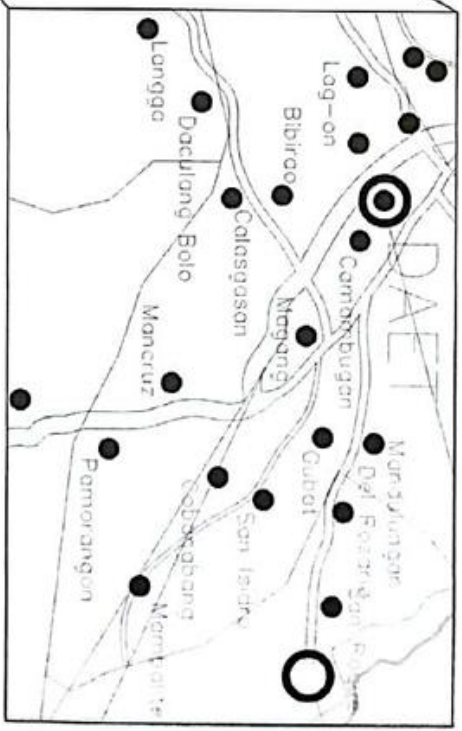
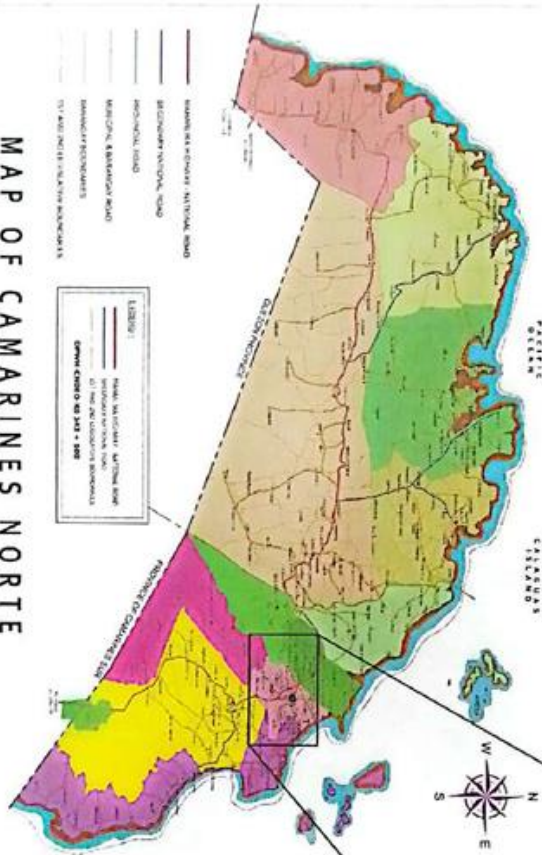

LOCATION MAP
 Scale: NTS

FEB 08 2014



PROVINCE OF CAMARINES NORTE
OFFICE OF THE
PROVINCIAL ENGINEER
DASIT, CAMARINES NORTE

PROJECT TITLE:
**CONSTRUCTION OF FARM TO
MARKET ROAD**
BPO: Calatagan, Dasit Camarines Norte

PREPARED BY:
ANGEL O. ARAGAY
MARY JANE SILEN

CHECKED & SUBMITTED BY:
SAMUEL T. YANTO
FRANCOIS DAVIDA

REVIEWED & VERIFIED BY:
FLORDELIZA B. ALER
ASST. PROVINCIAL ENGINEER

RECOMMENDING APPROVAL:
JOHN MARILYN S. TOBIAS
ASST. ENGINEER

APPROVED BY:
JOSEPH W. ASCUTYA
RICARTE R. PADILLA
PROVINCIAL ENGINEER

SHEET CONTENT
SHEET NO. 2 / 9

MATERIAL SOURCE MAP
Scale
NED

USE OF CAMARINES NORTE
LEGEND
ROADS
RIVER
RAILROAD
MATERIAL SOURCE
MATERIAL SOURCE



Item No.	Description	Quantity	Unit
A11(3)	Provision of Field Office for the engineer	4	sqm
A11(8)	Provision of additional fire service vehicle for the engineer to within bars	1	piece
B.5	Project Disposal/embankment	1	sqm
B.7	Occurrence Safety and Health	4	sqm
B.9	Maintenance Demolition	5.4	sqm
100(3)	Clearing and Fencing (with Shoring)	427.7	sqm
101(4)	Repair of Existing Concrete Retention	647.81	sqm
102(1)	Excavation (Surplus Concrete)	141.21	sqm
103	Structure Excavation	447.71	sqm
104	Excavation	28.64	sqm
105(1)	Soil Grout Penetration	1028.07	sqm
106(1)	Aggregate Sub Base Course	279.35	sqm
111(2)	FOCE (underground) 0.20m thick	1,029.81	sqm
120(1)	Strip Masonry	194.79	sqm

SUMMARY OF QUANTITIES

FEB 08 2011

GENERAL NOTES

- a. STATIONS ARE GIVEN IN KILOMETERS WITH GP WITHOUT DECIMALS.
- b. PIPE CULVERT DIAMETERS AND DIMENSIONS ARE GIVEN IN METERS.
- c. RAIL, ELEVATIONS, FLOOD LEVELS, ETC. ARE GIVEN IN METERS WITH OR WITHOUT DECIMALS.
- d. UNLESS OTHERWISE SHOWN, ALL DISTANCE ARE IN METERS.
- e. THE ROAD STATIONS AND ELEMENTS OF CURVES ARE RELATIVE TO THE CENTER LINE OF THE ROAD.
- f. ALL STATIONS ALONG ROAD CENTERLINE ARE RECKONED FROM EXISTING BARANGAY ROAD.

- g. ELEVATIONS GIVEN IN COLUMN "FINISHED GRADE ELEVATION" REFER TO THE GRADE AS SHOWN IN THE TYPICAL ROADWAY SECTION.
- h. GROUND LEVEL AND FINISH ROAD LEVEL OF THE ROAD REFER TO THE GROUND PROFILE FOR THE ROAD CENTERLINE.

MATERIALS SPECIFICATIONS:

AGGREGATES FOR SUB BASE COURSE SHALL CONSIST OF HARD, DURABLE PARTICLES OR FRAGMENTS OF CRUSHED STONES, CRUSHED SLABS OR CRUSHED OR NATURAL GRAVEL AND FILLER OR CRUSHED SAND OR OTHER FINELY DIVIDED MINERAL MATTER. THE COMPOSITE MATERIAL SHALL BE OF SUCH NATURE THAT IT CAN BE COMPACTED READILY TO FORM A FIRM EMBANKMENT.

- a. EMBANKMENT PROTECTION IS GENERALLY PROVIDED AREAS AND OTHER LOCATIONS SHOWN IN THE PLAN.
- b. MUCKS LAYERS MUST BE REMOVED FIRST BEFORE EMBANKMENT IS PLACED. CANALS AND DICES MUST BE CONSTRUCTED AFTER THE FOOTING.
- c. DRAINAGE SCHEDULE FOR CULVERTS AND BOX CULVERTS ARE SHOWN IN THE PLANS.

- a. LOCATION OF EXISTING DRAINAGE STRUCTURES, INVERT ELEVATIONS, SIDE DITCHES SHALL BE VERIFIED AND ADJUSTED TO SUIT ACTUAL FIELD CONDITIONS. CONDITIONS OF DRAINAGE STRUCTURES TO BE EXTENDED MUST BE CHECKED FOR DEFECTS. ALL DEFECTS SHALL BE REPAIRED BEFORE EXTENSIONS ARE MADE. EXTENSIONS AND OTHER IMPROVEMENTS OF EXISTING DRAINAGE STRUCTURES ARE SUBJECT TO CHANGE AND SHALL BE DETERMINED IN THE FIELD BY THE ENGINEER.
- b. CULVERTS SHALL BE PROVIDED WITH GRANULAR PIPE BEDDING.
- c. ANY MISCELLANEOUS REMOVAL NOT SHOWN ON THE PLANS INCLUDING REMOVING THE HEADWALLS AND WINGWALLS OF EXISTING DRAINAGE STRUCTURES THAT ARE TO BE EXTENDED OR IMPROVED AND THE DISPOSAL OF RESULTING MATERIALS SHALL BE CONSIDERED AS SUBSIDIARY WORK PERTAINING TO OTHER CONTRACT ITEMS.

DESIGN PARAMETER:

- 1 Right of Way: 15.00 m Minimum
- 2 Super elevation: 8.00 % Maximum
- 3 Cross Slope: 1.50 % - 2.00 %
- 4 Carriageway and Paved Shoulders: 3.00 %
- 5 Gravel Shoulder Surfacing: 1.50 %
- 6 Sidewalk and Gutter: 0.10
- 7 Carriageway width: 1.00 m
- 8 Length of Tangent between Reverse Curve: 30.00 m Min., 60.00 m Max., term Pl
- 9 Length of Vertical Curve: 60.00 m Min., term Pl
- 10 Longitudinal grade: 0.50 % Min., 12.00 % Max.
- 11 On Cut/Fill Section: 1.5:1 to 1:1
- 12 Common materials cut slope: 0.50:1 to 1:1
- 13 Riprap cut slope: 0.25:1 to 0.50:1
- 14 Hard/solid rock: 1.5:1
- 15 Minimum fill slope: 9:10.00 mm Min.
- 16 (Pipe culvert, 15-yr flood with sufficient freeboard to contain the 25-year flood return period)
- 17 Slope protection: 200mm Min.
- 18 Aggregate Subbase Course thickness: 200mm Min.
- 19 PCGP: 15mm dia. D58 @ 0.75m spacing x 0.60m length
- 20 Davel and Tie Bars: 15mm dia. Plan round bar @ 0.30m spacing x 0.60m length
- 21 Warnings signs: Refer to DPWH Highway Safety Manual
- 22 Pavement Workings: Refer to DPWH Highway Safety Manual

FEB 08 2024



PROVINCE OF DAVAO OCCIDENTAL
OFFICE OF THE
PROVINCIAL ENGINEER
DAVAO OCCIDENTAL

PROJECT TITLE: CONSTRUCTION OF FARM TO MARKET ROAD Brg. Cudangbang, Davao Occidental	PREPARED BY: ANGELICA B. BACAY ANGRY JAVIER BACAY REGISTERED CIVIL ENGINEER	CHECKED & SUBMITTED BY: SAHLE T. YANTO CP - EXAMINER DIVISION	REVIEWED & VERIFIED BY: FLORENCE B. ALER ASST. REGISTRAR	RECOMMENDING APPROVAL: JOHN MARVIN S. TORIAS REGISTERED CIVIL ENGINEER	APPROVED BY: JOSEPH V. ASDUTIA Acting Governor RICARTE R. PADILLA PROVINCIAL GOVERNOR	SHEET CONTENT: GENERAL NOTES DESIGN CONTRACT	SHEET NO.: 3 / 9
---	---	--	---	---	--	---	----------------------------

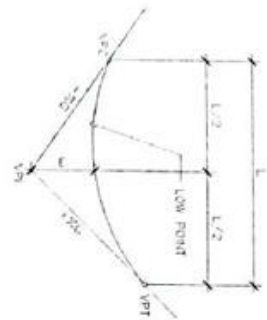

- LEGEND:
- VPI - VERTICAL POINT OF INTERSECTION
 - VPC - VERTICAL POINT OF CURVATURE
 - VPT - POINT OF TANGENCY
 - L - LENGTH OF VERTICAL CURVE
 - K - R FACTOR
 - E - EXTERNAL DISTANCE
 - 7% - PERCENT GRADE

VERTICAL PARABOLIC CURVE (SYMMETRICAL)

NOT DRAWN TO SCALE

NOTE:

HORIZONTAL CURVE (CIRCULAR)

NOT DRAWN TO SCALE

FOR ANY VERTICAL PARABOLIC CURVE

$$h = (g_2 - g_1) LVC/8$$

$$K = L/A$$

$$A = (g_2 - g_1)$$

LEGEND:

- PI - POINT OF INTERSECTION
- PC - POINT OF CURVATURE
- PT - POINT OF TANGENCY
- I/x - INTERSECTION ANGLE
- D_a - DEGREE OF CURVATURE (ARC DEFINITION)
- D_c - DEGREE OF CURVATURE (CHORD DEFINITION)
- T - TANGENT LENGTH
- R - HORIZONTAL RADIUS
- L - LENGTH OF CURVATURE
- C - CHORD LENGTH
- E - EXTERNAL DISTANCE
- M - EXTERNAL DISTANCE

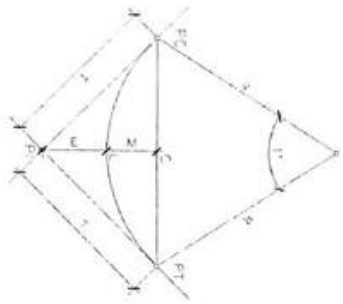

FORMULAS:

$$T = R \tan \frac{I}{2}$$

$$C = 2R \sin \frac{I}{2}$$

$$M = R \left(1 - \cos \frac{I}{2} \right)$$

$$E = R_x \left(\sec \frac{I}{2} \right)$$

$$D = 1145.916/R$$

$$L_c = \frac{D_c \times I \times R}{180}$$

$$L_e = \frac{D_c \times T \times I}{20 \times I}$$

FOR 1% ASSUMED ANG = 100m;
FOR 2% ASSUMED CHORD = 100m
ANGLE "I" IS SUBTENDED BY 420m ARC
NO HORIZONTAL CURVE IS REQUIRED WHERE THE CENTRAL ANGLE IS LESS THAN ONE(1) DEGREE
ALGEBRAIC DIFFERENCES IS 50% OR LESS

 PROVINCE OF CEBU OFFICE OF THE PROVINCIAL ENGINEER DR. T. CORDOBA	PROJECT TITLE: CONSTRUCTION OF FARM TO MARKET ROAD Brgy. Calalang, Davao Oriental	PREPARED BY: ANGELIE BLADAY ENGINEER MARY JANE BELLEN ENGINEER	CHECKED & SUBMITTED BY: SAULET T. YANTO CHIEF ENGINEER	REVIEWED & VERIFIED BY: FLORENCE B. ALER ASST. PROVIN. ENGR.	RECOMMENDING APPROVAL: JOHN MARVILUS TOBIAS PROVIN. ENGR.	APPROVED BY: JOSEPH V. ASCUTIA Acting Governor ROBERTO R. PADILLA PROVIN. ENGR.	SHEET CONTENT ELEMENTS OF CURVE SHEET NO. 4 / 9
---	--	--	--	--	---	---	---

FEB 08 2024



PROVINCE OF MANITOBA
OFFICE OF THE
PROVINCIAL ENGINEER
DAN I. CAMARINIS NORTH

PROJECT TITLE:
**CONSTRUCTION OF FARM TO
MARKET ROAD**
Eggs, Coleman, Dist. Camarinis North

PREPARED BY:
ANGEL R. BARAGAY
MARY JANE BELEN

CHECKED & SUBMITTED BY:
SMILEY T. YANTO

REVIEWED & REVISIONS BY:
FLORENZELLA ALER

RECOMMENDING APPROVAL:
JOHN MARTEL S. TOBIAS

APPROVED BY:
JOSEPH V. ASCUTIA
Acting Governor
RICARTE R. PADILLA

SHEET NO. 5 / 9

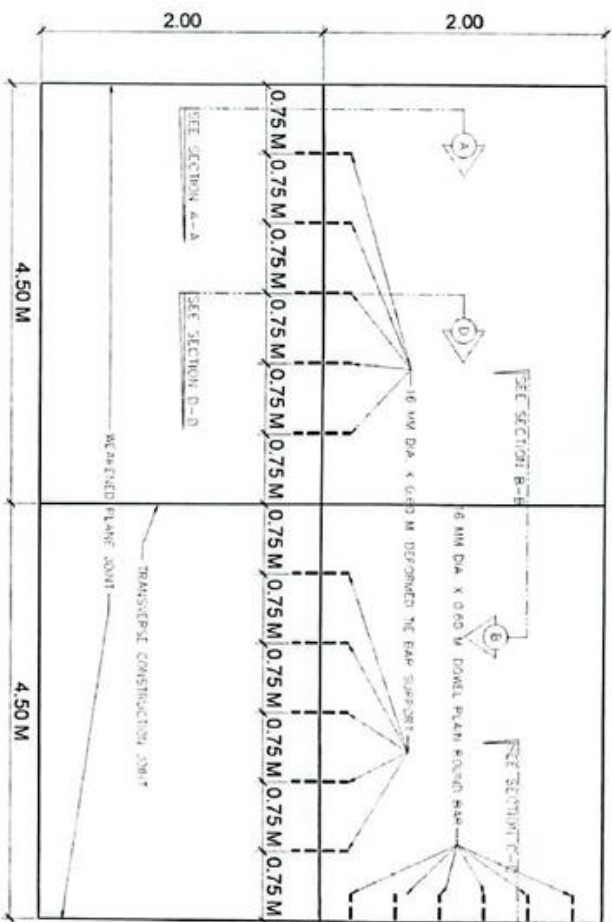

ROADWAY PLAN (FOR TWO LANE PAVEMENT)
NOT TO SCALE

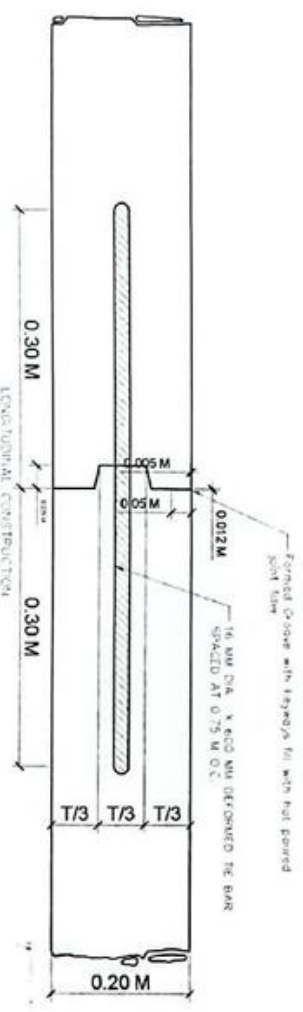

SCALE 1:5

FEB 08 2024

- NOTE
1. TRANSVERSE CONSTRUCTION/CONTACT JOINT SHALL BE PROVIDED AT THE END OF ANY RUN WHERE LAYING OF CONCRETE HAS BEEN STOPPED FOR THIRTY MINUTES (30M) MINIMUM OR LONGER
 2. TRANSVERSE CONSTRUCTION JOINTS WHICH OCCUR AT LOCATION OF WEAKENED PLANE JOINTS SHOULD BE BUILT JOINTS WITH DOWELS IF THE JOINT OCCURS IN THE MIDDLE THIRD OF THE WEAKENED JOINT INTERVAL (1.50M TO 3.0M) IT SHOULD BE KEVED JOINTS WITH THE BARS
 3. DRILLING OF HOLES ON EXISTING POOP AND AFTER STRUCTURES SHALL BE PERFORMED USING POWER TOOLS. THE HOLES SHALL BE PROPERLY CLEANED BEFORE GROUT/POXY INJECTION AND INSTALLATION OF DOWEL/STE BAR

LANE SHOWING TRANSVERSE CONSTRUCTION JOINT AT LOCATION OF WEAKENED PLANE JOINT



OFFICE OF CAMARINES NORTE
 OFFICE OF THE
 PROVINCIAL ENGINEER
 DPT. COMMERCE HORTI

PROJECT TITLE:
**CONSTRUCTION OF FARM TO
 MARKET ROAD**
 Brgy. Calabang, Davao Comanche, Marikina

PREPARED BY:
 ANGELO P. BARRERA
 CIVIL ENGINEER

CHECKED & SUBMITTED BY:
 SHARLE T. YANIG
 CIVIL ENGINEER

REVIEWED & VERIFIED BY:
 RONDELIZO ALER
 CIVIL ENGINEER

RECOMMENDING APPROVAL:
 JOHN MARVIN S. TORIBAS
 CIVIL ENGINEER

APPROVED BY:
JOSEPH V. ABCUTIA
 Acting Governor
 RICARTE B. BARRERA
 PROVINCIAL ENGINEER

SHEET NO. 6 / 9

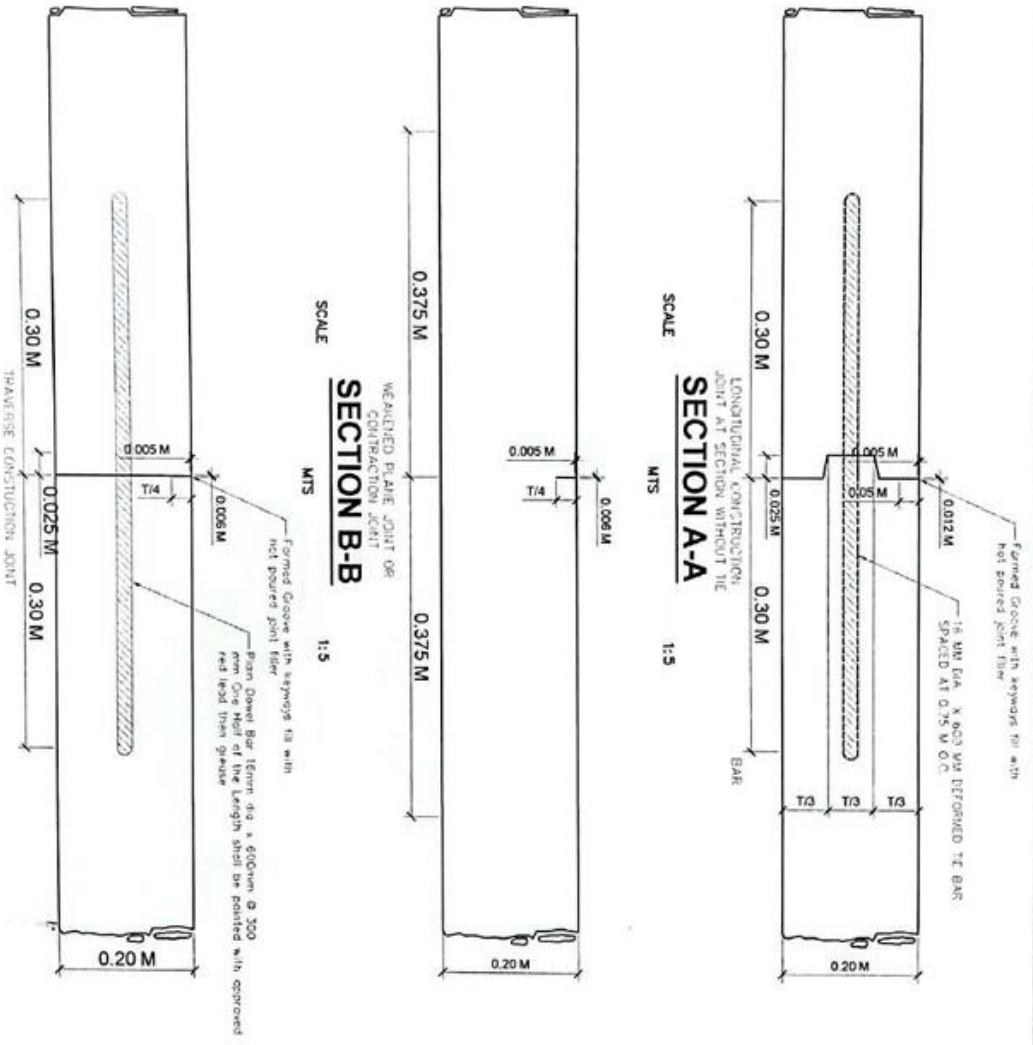

FEB 08 2024



PROVINCE OF CAMARINES NORTE
OFFICE OF THE
PROVINCIAL ENGINEER
DART, CAMARINES NORTE

PROJECT TITLE:
**CONSTRUCTION OF FARM TO
MARKET ROAD**
Brgy. Calampang, Dait Camarines Norte

PREPARED BY:
ANGELA P. BALANGAY
ANGY JANE ELEN

CHECKED & SUBMITTED BY:
SAHLEE T. YANTO

REVIEWED & CHECKED BY:
TEORIELIZA B. ALER

RECOMMENDING APPROVAL:
JOHN PERRY L. S. TOBIAS

APPROVED BY:
JOSEPH X. ASCUTIA
Acting Governor
RICARTE R. PADILLA
PROVINCIAL GOVERNOR

SHEET COUNT:
SHEET NO. 9 / 9

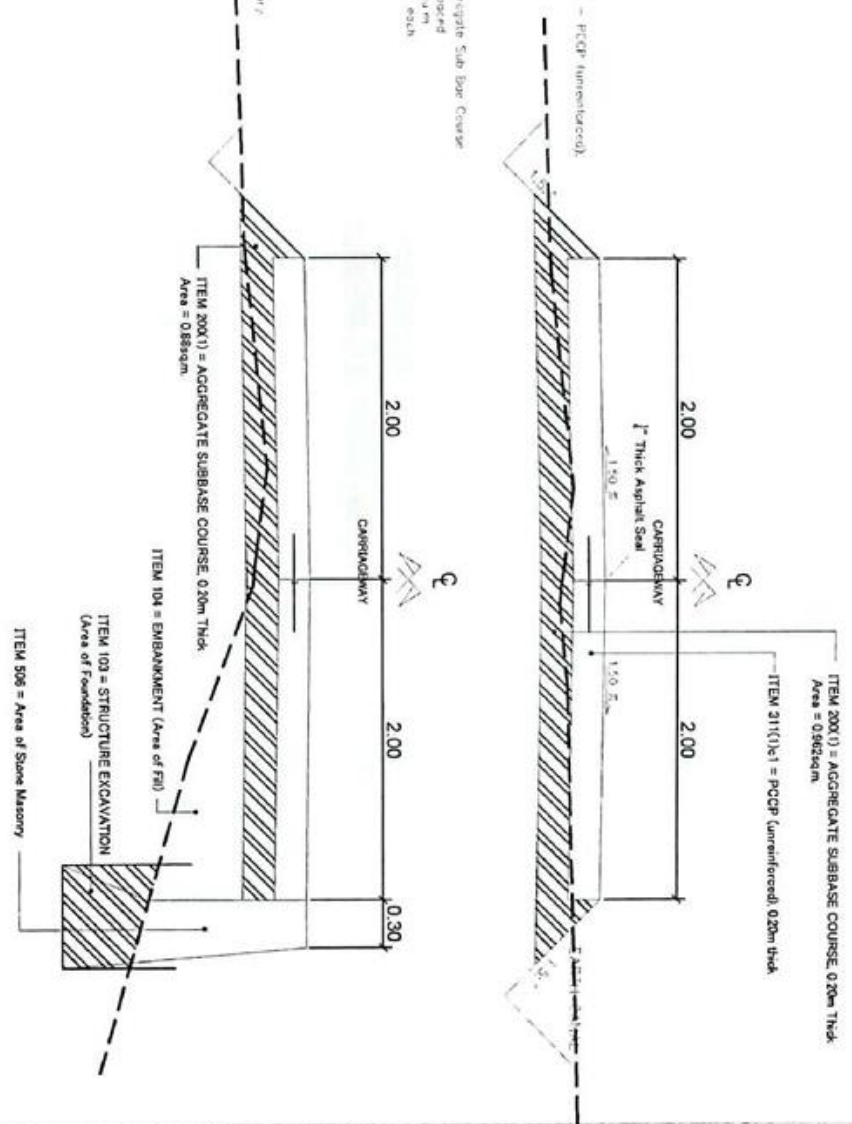
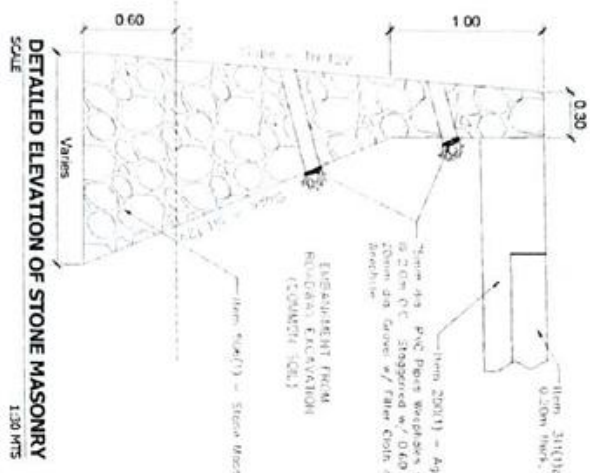



PROVINCE OF CAVENDISH NORTH
 OFFICE OF THE
 PROVINCIAL ENGINEER
 DIST. CAVENDISH NORTH

PROJECT TITLE:
**CONSTRUCTION OF FARM TO
 MARKET ROAD**
 Big. Calumpang Dist. Cavendish North

PREPARED BY:
 ANGELINA P. LABAGAY
 MARY JANE RELEN
 ENGINEER

CHECKED & SUBMITTED BY:
 SYDNEY T. YANIG
 CIVIL ENGINEER

REVIEWED & VERIFIED BY:
 FLORENCE B. ALER
 ASST. DIVISION ENGINEER

RECOMMENDING APPROVAL:
 JOHN MARCEL S. TORRES
 DISTRICT ENGINEER

APPROVED BY:
 JOSEPH V. ASCUTIA
 RICARTE R. PADILLA
 PROVINCIAL GOVERNOR

SHEET NO. 3 / 3

STRAIGHT LINE DIAGRAM
 SCALE: NTS

FEB 08 2024

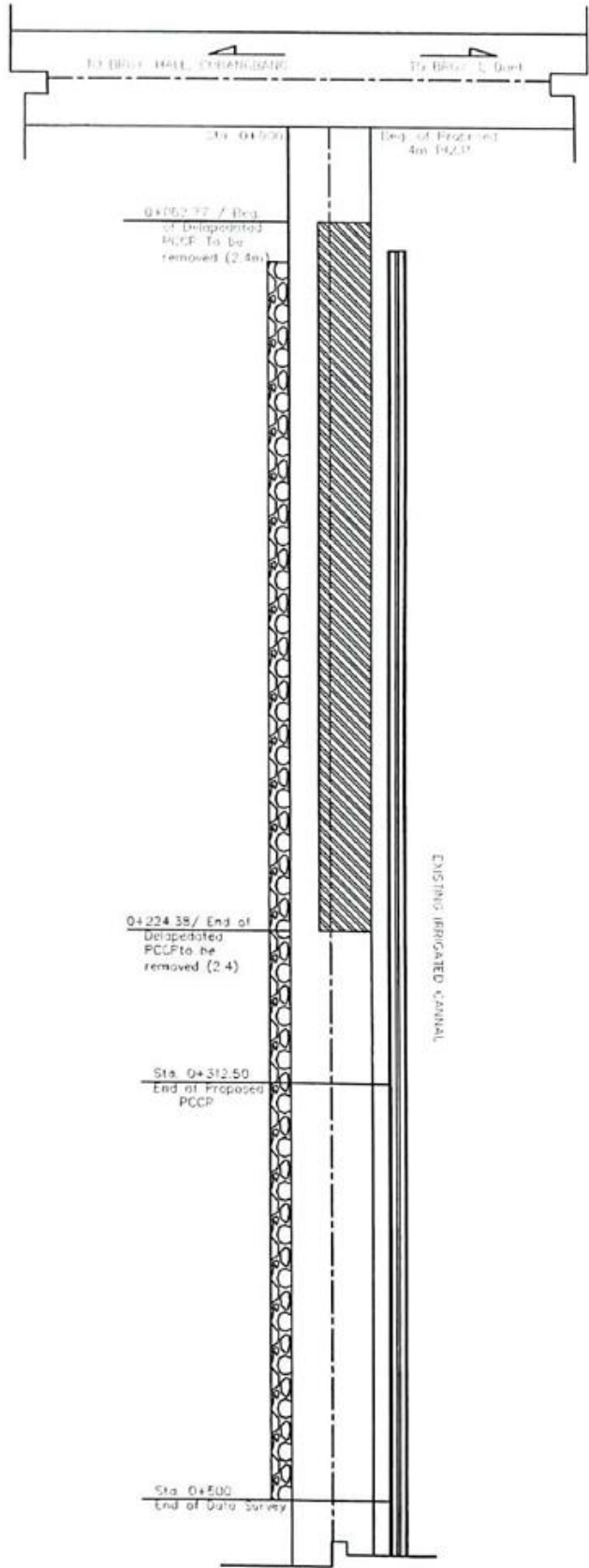



PROVINCE OF CAMARINES NORTE
 OFFICE OF THE
 PROVINCIAL ENGINEER
 BATAI, CAMARINES NORTE

PROJECT TITLE:
**CONSTRUCTION OF FARM TO
 MARKET ROAD**
 Brgy. Calabang, Daet-Camarines Norte

PREPARED BY:
ANGELA P. BARAGAY
 PROJECT ENGINEER
MARY JANE SILEN
 ARCHITECT

CHECKED & SUBMITTED BY:
SAMUEL T. YANTO
 CHIEF PLANNING DIVISION

REVIEWED & VERIFIED BY:
FLORENCE B. ALER
 AML. FROM
 CIVIL ENGINEER

RECOMMENDING APPROVAL:
JOHN MARVIN S. TORIBUS
 PROJECT ENGINEER

APPROVED BY:
JOSEPH V. ASCUTIA
 Acting Governor
 RICARTE R. PADILLA
 PROVINCIAL GOVERNOR

SHEET CONTENT
 Project Billboard
 SHEET NO. 3 / 4

(BILLBOARD 1) FRONT & REAR ELEVATION
 SCALE 1:200 METERS

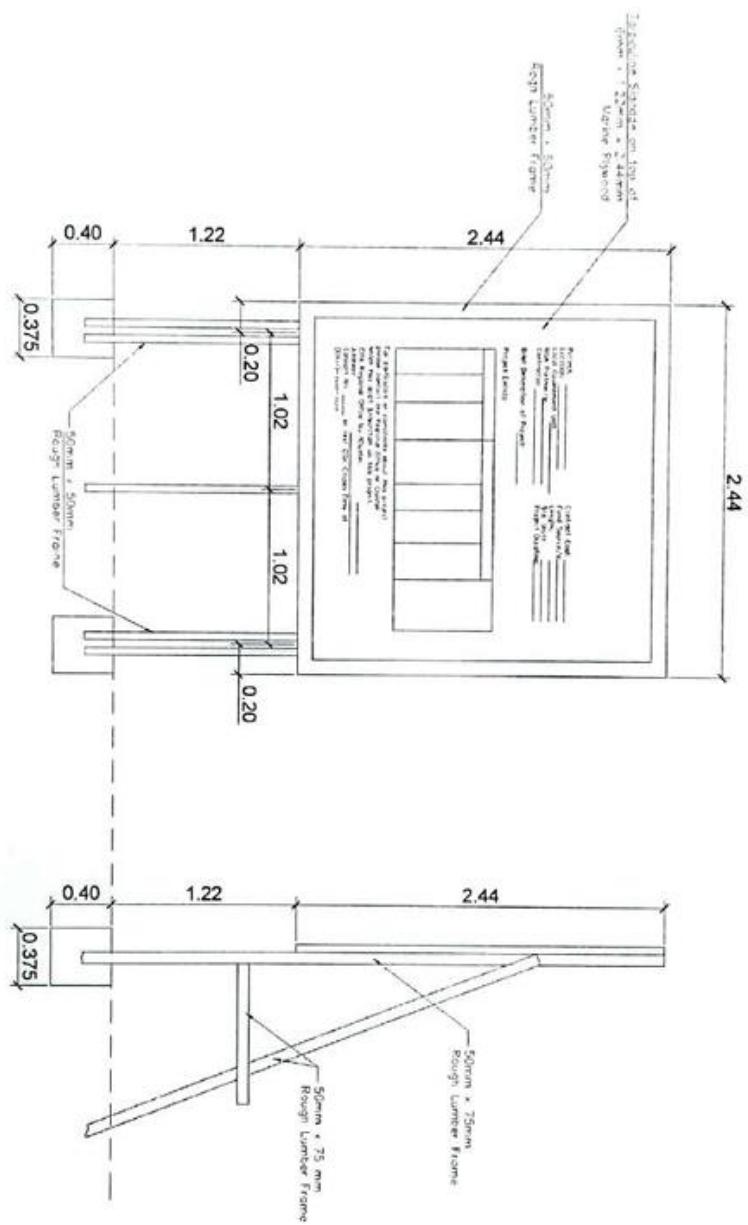

FEB 08 2024

LEGEND:

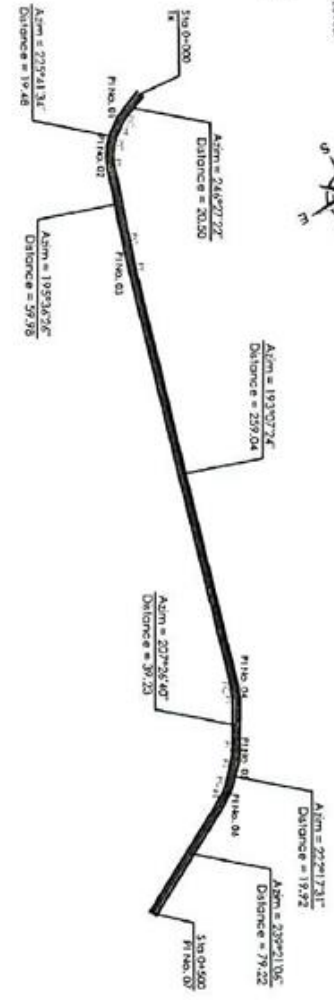
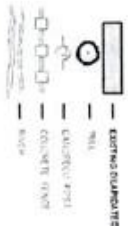

Sta.	Station	1	2	3	4	5	6	7	8	9	10	11	12	13	14	15	16	17	18	19	20	21	22	23	24	25	26	27	28	29	30	31	32	33	34	35	36	37	38	39	40	41	42	43	44	45	46	47	48	49	50																																																						
1	1+000.00	20	51	47	30.50	5.00	10.00	15.00	20.00	25.00	30.00	35.00	40.00	45.00	50.00	55.00	60.00	65.00	70.00	75.00	80.00	85.00	90.00	95.00	100.00	105.00	110.00	115.00	120.00	125.00	130.00	135.00	140.00	145.00	150.00	155.00	160.00	165.00	170.00	175.00	180.00	185.00	190.00	195.00	200.00	205.00	210.00	215.00	220.00	225.00	230.00	235.00	240.00	245.00	250.00	255.00	260.00	265.00	270.00	275.00	280.00	285.00	290.00	295.00	300.00	305.00	310.00	315.00	320.00	325.00	330.00	335.00	340.00	345.00	350.00	355.00	360.00	365.00	370.00	375.00	380.00	385.00	390.00	395.00	400.00	405.00	410.00	415.00	420.00	425.00	430.00	435.00	440.00	445.00	450.00	455.00	460.00	465.00	470.00	475.00	480.00	485.00	490.00	495.00	500.00

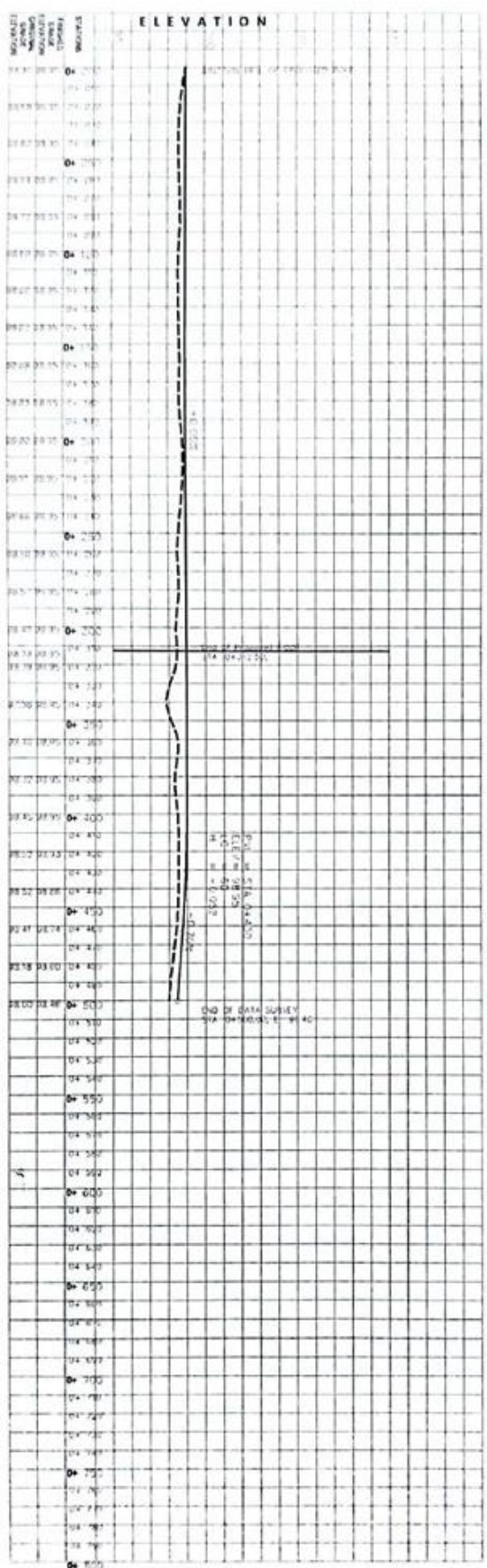

PROVINCE OF CAGAYAN NORTE
 OFFICE OF THE
 PROVINCIAL ENGINEER
 DIST. CAGAYAN NORTH

PROJECT TITLE:
**CONSTRUCTION OF FARM TO
 MARKET ROAD**
 Brgy. Caramanding, Davao Caramana West

PREPARED BY:
 ANGEL F. BABAGAY
 MARY JANE SILLAN

CHECKED & SUBMITTED BY:
 SAMUEL T. YANTO

REVIEWED & REPIED BY:
 FLORENZITA B. ALAR

RECOMMENDING APPROVAL:
 JOHN MARVILLE S. TOBIAS

APPROVED BY:
JOSEPH V. ACUTIA
 Acting Governor
 RICARTE R. PADILLA
 PROVINCIAL ENGINEER

SHEET NO. 1
 SHEET CONTENT

FEB 09 2011



PROVINCE OF CAMARINES NORTE
OFFICE OF THE
PROVINCIAL ENGINEER
DAVAO, CAMARINES NORTE

PROJECT TITLE:
**CONSTRUCTION OF FARM TO
MARKET ROAD**
Egr. Calagrang, Davao Camarines Norte

PREPARED BY:
[Signature]
ANGELITA B. BACAY
PROVINCIAL ENGINEER
MARY JANIE ELEN
ASSISTANT ENGINEER

CHECKED & SUBMITTED BY:
[Signature]
SAHUR T. YANTO
ASSISTANT ENGINEER

REVIEWED & VERIFIED BY:
[Signature]
MOBBERDIA ALER
ASSISTANT ENGINEER

RECOMMENDING APPROVAL:
[Signature]
JOHN MARCEL S. TORIAS
ASSISTANT ENGINEER

APPROVED BY:
[Signature]
JOSEPH V. ANTONIA
Acting Governor
RICARTE R. PADILLA
PROVINCIAL GOVERNOR

SHEET NO. 1 of 3

FEB 08 2014

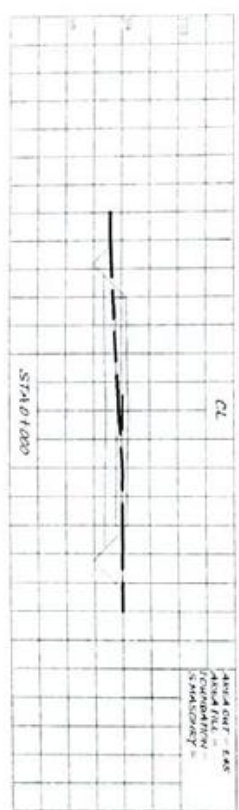

98 98

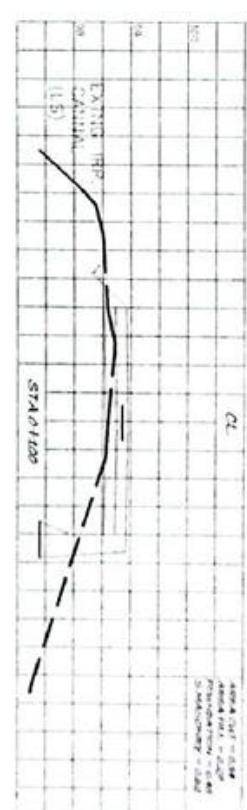
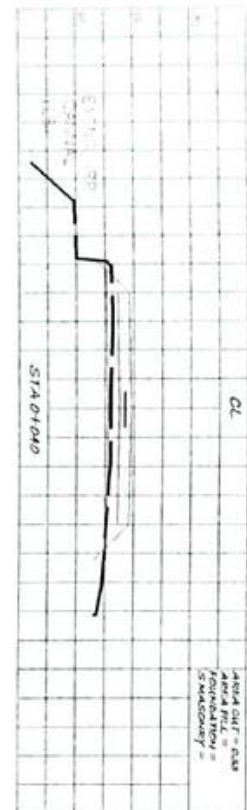
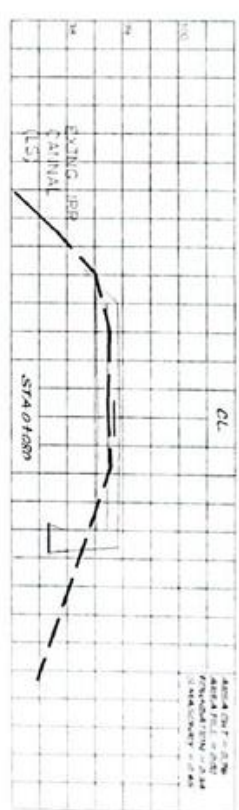
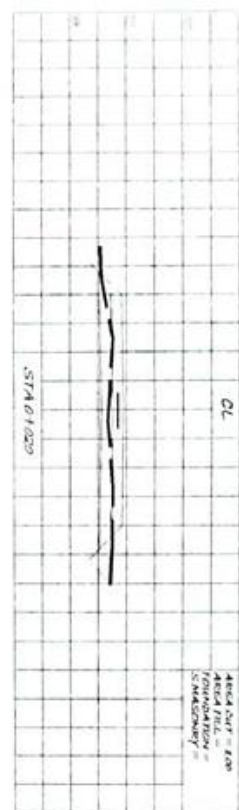



PROVINCE OF CAUVENDISH NORTH
OFFICE OF THE
PROVINCIAL ENGINEER
DART, CAUVENDISH NORTH

PROJECT TITLE:
**CONSTRUCTION OF FARM TO
MARKET ROAD**
Bog Calangbang, Dart Cavendish North

PREPARED BY:
ANGELA P. BARAGAY
PROVINCIAL ENGINEER
MARY JANE HELEN

CHECKED & SUBMITTED BY:
[Signature]
SAULET YANTO
PROVINCIAL ENGINEER

REVIEWED & VERIFIED BY:
[Signature]
FLORENCE A. ALER
PROVINCIAL ENGINEER

RECOMMENDING APPROVAL:
[Signature]
JOHN MARVILLE S. TORIAS
PROVINCIAL ENGINEER

APPROVED BY:
JOSEPH V. ASDITTIA
Acting Governor
RICARTE R. PADILLA
PROVINCIAL GOVERNOR

SHEET CONTENT:
GROSS
SECTION
SHEET NO. 2 / 3

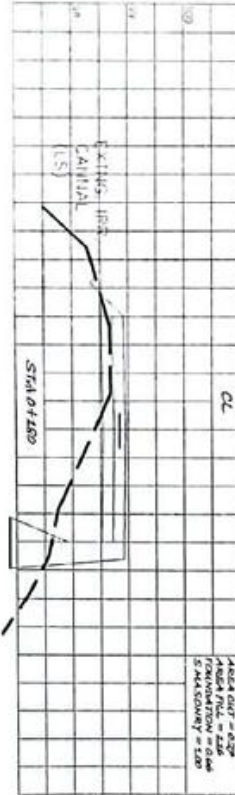
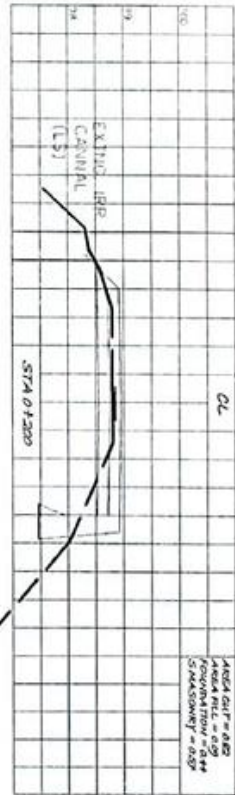
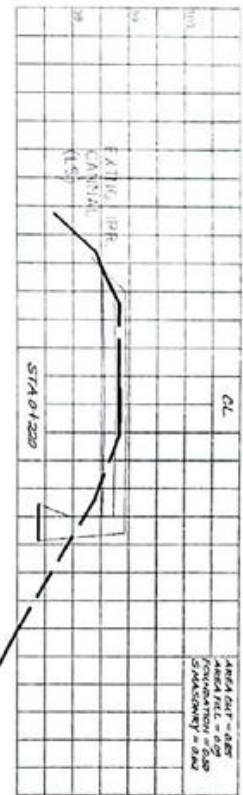
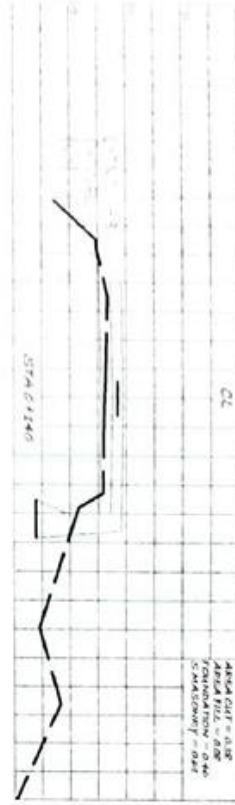
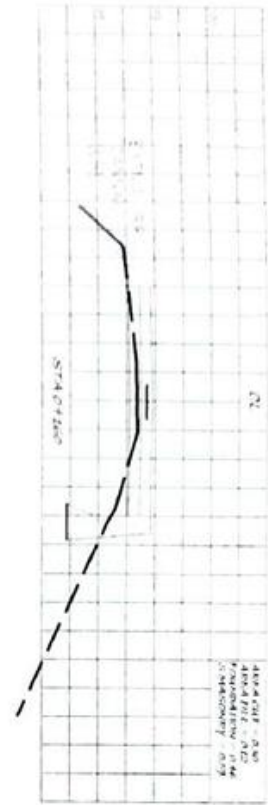

0.50m Offset to the Right
FEB 09 2024



PROVINCE OF CAMARINES NORTE
OFFICE OF THE
PROVINCIAL ENGINEER
DEPT. CAMARINES NORTE

PROJECT TITLE
**CONSTRUCTION OF FARM TO
MARKET ROAD**
Brgy. Calangdang, Davao Occidental

PREPARED BY
ANGELYN PADAYAG
MARTIN ZHARLEN

CHECKED & SUBMITTED BY:
SAUL T. YANTO
MARTIN ZHARLEN

REVIEWED & VERIFIED BY:
ELONORZA B. ALER
MARTIN ZHARLEN

RECOMMENDING APPROVAL:
JOHN M. S. TOBUS
MARTIN ZHARLEN

APPROVED BY:
RICARTE R. PADILLA
PROVINCIAL ENGINEER

SHEET NO. 3 / 3
CROSS SECTION

FEB 08 2009

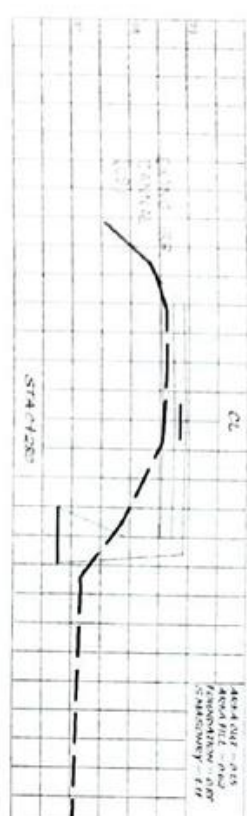
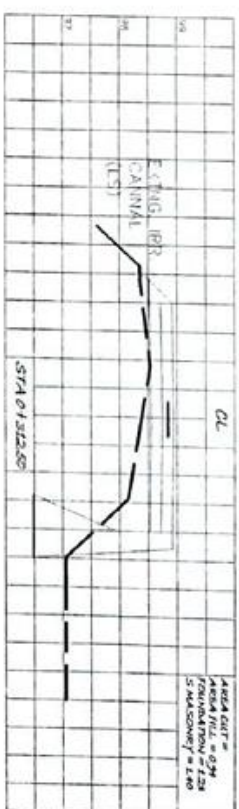
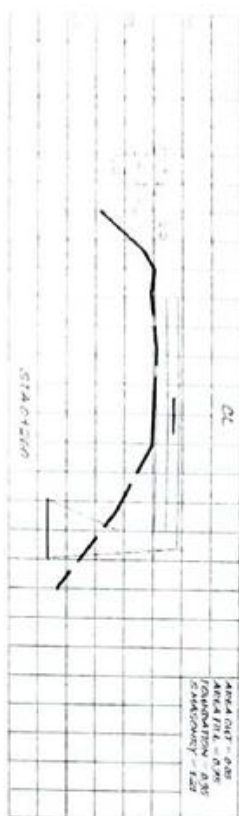
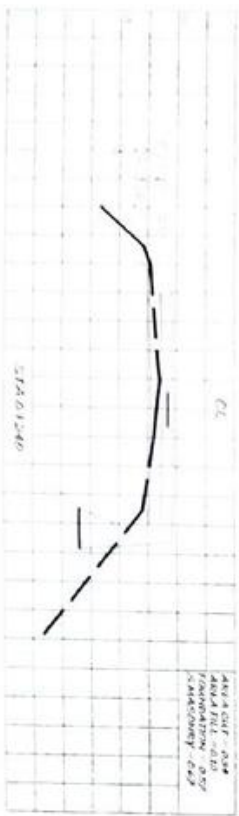

DRAWINGS AVAILABLE AT THE BAC OFFICE

Section VIII. Bill of Quantities

BILL OF QUANTITIES
CONSTRUCTION OF FARM TO MARKET ROAD

Brgy. Cobangbang, Daet, Camarines Norte

Item No.	Scope of Work	Unit	Quantity	Unit Price	TOTAL
A.1.1(3)	Provision of field office for the engineer	Month	4.00		
A.1.1(8)	Provision of 4x4 pickup type service vehicle for the engineer on rental basis	Days	15.00		
B.5	Project Billboard/Signboard	Each	1.00		
B.7	Occupational Safety and Health Program	Month	4.00		
B.9	Mobilization/Demobilization	LS	1.00		
100(1)	Clearing & Grubbing (with Stripping)	Sq.m.	625.00		
101(4)a	Removal of Existing Concrete Pavement	Sq.m.	387.86		
102(1)	Roadway Excavation (Surplus Common)	Cu.m.	143.33		
103	Structure Excavation	Cu.m.	149.73		
104	Embankment	Cu.m.	98.64		
105(1)	Subgrade Preparation	Sq.m	1,250.00		
200(1)	Aggregate Sub base Course	Cu.m	279.36		
311(1)	Portland Cement Concrete Pavement (Unreinforced) 0.20m thk.	Sq.m	1,250.00		
506(1)	Stone Masonry	Cu.m.	195.39		
TOTAL					

Amount in words:

Signature over Printed Name

Date:

Section IX. Checklist of Technical and Financial Documents

Checklist of Technical and Financial Documents

I. TECHNICAL COMPONENT ENVELOPE

Class "A" Documents

Legal Documents

- (a) Valid PhilGEPS Registration Certificate (Platinum Membership) (all pages);

Technical Documents

- (b) Statement of the prospective bidder of all its ongoing government and private contracts, including contracts awarded but not yet started, if any, whether similar or not similar in nature and complexity to the contract to be bid; **and**
- (c) Statement of the bidder's Single Largest Completed Contract (SLCC) similar to the contract to be bid, except under conditions provided under the rules; **and**
- (d) Special PCAB License in case of Joint Ventures; **and** registration for the type and cost of the contract to be bid; **and**
- (e) Original copy of Bid Security. If in the form of a Surety Bond, submit also a certification issued by the Insurance Commission; **or**
Original copy of Notarized Bid Securing Declaration; **and**
- (f) Project Requirements, which shall include the following:
 - a. Organizational chart for the contract to be bid;
 - c. List of contractor's key personnel (*e.g.*, Project Manager, Project Engineers, Materials Engineers, and Foremen), to be assigned to the contract to be bid, with their complete qualification and experience data;
 - d. Key Personnel's Certificate of Employment (notarized)
 - e. List of contractor's major equipment units, which are owned, leased, and/or under purchase agreements, supported by proof of ownership or certification of availability of equipment from the equipment lessor/vendor for the duration of the project, as the case may be; **and**
- (g) Original duly signed Omnibus Sworn Statement (OSS);

and if applicable, Original Notarized Secretary's Certificate in case of a corporation, partnership, or cooperative; or Original Special Power of Attorney of all members of the joint venture giving full power and authority to its officer to sign the OSS and do acts to represent the Bidder.

Financial Documents

- (h) The prospective bidder's audited financial statements, showing, among others, the prospective bidder's total and current assets and liabilities, stamped "received" by the BIR or its duly accredited and authorized institutions, for the preceding calendar year which should not be earlier than two (2) years from the date of bid submission; **and**
- (i) The prospective bidder's computation of Net Financial Contracting Capacity (NFCC).

Class "B" Documents

- (j) If applicable, duly signed joint venture agreement (JVA) in accordance with RA No. 4566 and its IRR in case the joint venture is already in existence;
or
duly notarized statements from all the potential joint venture partners stating that they will enter into and abide by the provisions of the JVA in the instance that the bid is successful.

II. FINANCIAL COMPONENT ENVELOPE

- (k) Original of duly signed and accomplished Financial Bid Form; **and**

Other documentary requirements under RA No. 9184

- (l) Original of duly signed Bid Prices in the Bill of Quantities; **and**
- (m) Duly accomplished Detailed Estimates Form, including a summary sheet indicating the unit prices of construction materials, labor rates, and equipment rentals used in coming up with the Bid; **and**
- (n) Cash Flow by Quarter.

BID FORM

Date : _____

Project Identification No. : _____

To: HON. RICARTE R. PADILLA
Governor
PLGU- Camarines Norte

Having examined the Philippine Bidding Documents (PBDs) including the Supplemental or Bid Bulletin Numbers *[insert numbers]*, the receipt of which is hereby duly acknowledged, we, the undersigned, declare that:

- a. We have no reservation to the PBDs, including the Supplemental or Bid Bulletins, for the Procurement Project: *[insert project name]*;
- b. We offer to execute the Works for this Contract in accordance with the PBDs;
- c. The total price of our Bid in words and figures, excluding any discounts offered below is: *[insert information]*;
- d. The discounts offered and the methodology for their application are: **NONE**;
- e. The total bid price includes the cost of all taxes, such as, but not limited to: *(i) value added tax (VAT), (ii) income tax, (iii) local taxes, and (iv) other fiscal levies and duties*, which are itemized herein and reflected in the detailed estimates,
- f. Our Bid shall be valid within the period stated in the PBDs, and it shall remain binding upon us at any time before the expiration of that period;
- g. If our Bid is accepted, we commit to obtain a Performance Security in the amount of **30%** percent of the Contract Price for the due performance of the Contract, or a **Performance Securing Declaration** in lieu of the allowable forms of Performance

Security, subject to the terms and conditions of issued GPPB guidelines¹ for this purpose;

- h. We are not participating, as Bidders, in more than one Bid in this bidding process, other than alternative offers in accordance with the Bidding Documents;
- i. We understand that this Bid, together with your written acceptance thereof included in your notification of award, shall constitute a binding contract between us, until a formal Contract is prepared and executed; and
- j. We understand that you are not bound to accept the Lowest Calculated Bid or any other Bid that you may receive.
- k. We likewise certify/confirm that the undersigned, is the duly authorized representative of the bidder, and granted full power and authority to do, execute and perform any and all acts necessary to participate, submit the bid, and to sign and execute the ensuing contract for the *[insert project name]* of the **Provincial Government of Camarines Norte**.
- l. We acknowledge that failure to sign each and every page of this Bid Form, including the Bill of Quantities, shall be a ground for the rejection of our bid.

Name: _____

Legal Capacity: _____

Signature: _____

Duly authorized to sign the Bid for and behalf of: _____

Date: _____

REPUBLIC OF THE PHILIPPINES)

CITY OF _____) S.S.

BID SECURING DECLARATION

Project Identification No.: *[Insert number]*

To: ***HON. RICARTE R. PADILLA***
Governor
PLGU- Camarines Norte

I/We, the undersigned, declare that:

1. I/We understand that, according to your conditions, bids must be supported by a Bid Security, which may be in the form of a Bid Securing Declaration.
2. I/We accept that: (a) I/we will be automatically disqualified from bidding for any procurement contract with any procuring entity for a period of two (2) years upon receipt of your Blacklisting Order; and, (b) I/we will pay the applicable fine provided under Section 6 of the Guidelines on the Use of Bid Securing Declaration, within fifteen (15) days from receipt of the written demand by the procuring entity for the commission of acts resulting to the enforcement of the bid securing declaration under Sections 23.1(b), 34.2, 40.1 and 69.1, except 69.1(f), of the IRR of RA No. 9184; without prejudice to other legal action the government may undertake.
3. I/We understand that this Bid Securing Declaration shall cease to be valid on the following circumstances:
 - a. Upon expiration of the bid validity period, or any extension thereof pursuant to your request;
 - b. I am/we are declared ineligible or post-disqualified upon receipt of your notice to such effect, and (i) I/we failed to timely file a request for reconsideration or (ii) I/we filed a waiver to avail of said right; and
 - c. I am/we are declared the bidder with the Lowest Calculated Responsive Bid, and I/we have furnished the performance security and signed the Contract.

IN WITNESS WHEREOF, I/We have hereunto set my/our hand/s this _____day of *[month]* *[year]* at *[place of execution]*.

[Insert NAME OF BIDDER OR ITS AUTHORIZED REPRESENTATIVE]

[Insert signatory's legal capacity]

Affiant

[Jurat]

[Format shall be based on the latest Rules on Notarial Practice]

Contract Agreement Form

[insert project name]

[not required to be submitted with the Bid, but it shall be submitted within ten (10) days after receiving the Notice of Award]

CONTRACT AGREEMENT

THIS AGREEMENT, made this *[insert date]* day of *[insert month]*, *[insert year]* between *[name and address of PROCURING ENTITY]* (hereinafter called the “Entity”) and *[name and address of Contractor]* (hereinafter called the “Contractor”).

WHEREAS, the Entity is desirous that the Contractor execute *[name and identification number of contract]* (hereinafter called “the Works”) and the Entity has accepted the Bid for *[contract price in words and figures in specified currency]* by the Contractor for the execution and completion of such Works and the remedying of any defects therein.

NOW THIS AGREEMENT WITNESSETH AS FOLLOWS:

1. In this Agreement, words and expressions shall have the same meanings as are respectively assigned to them in the Conditions of Contract hereinafter referred to.
2. The following documents as required by the 2016 revised Implementing Rules and Regulations of Republic Act No. 9184 shall be deemed to form and be read and construed as part of this Agreement, *viz.*:
 - a. Philippine Bidding Documents (PBDs);
 - i. Drawings/Plans;
 - ii. Specifications;
 - iii. Bill of Quantities;
 - iv. General and Special Conditions of Contract;
 - v. Supplemental or Bid Bulletins, if any;
 - b. Winning bidder’s bid, including the Eligibility requirements, Technical and Financial Proposals, and all other documents or statements submitted;

Bid form, including all the documents/statements contained in the Bidder’s bidding envelopes, as annexes, and all other documents submitted (*e.g.*, Bidder’s response

to request for clarifications on the bid), including corrections to the bid, if any, resulting from the Procuring Entity's bid evaluation;

- c. Performance Security;
 - d. Notice of Award of Contract and the Bidder's conforme thereto; and
 - e. Other contract documents that may be required by existing laws and/or the Procuring Entity concerned in the PBDs. **Winning bidder agrees that additional contract documents or information prescribed by the GPPB that are subsequently required for submission after the contract execution, such as the Notice to Proceed, Variation Orders, and Warranty Security, shall likewise form part of the Contract.**
3. In consideration for the sum of *[total contract price in words and figures]* or such other sums as may be ascertained, *[Named of the bidder]* agrees to *[state the object of the contract]* in accordance with his/her/its Bid.
4. The *[Name of the procuring entity]* agrees to pay the above-mentioned sum in accordance with the terms of the Bidding.

IN WITNESS whereof the parties thereto have caused this Agreement to be executed the day and year first before written.

[Insert Name and Signature]

[Insert Name and Signature]

[Insert Signatory's Legal Capacity]

[Insert Signatory's Legal Capacity]

for:

for:

[Insert Name of Supplier]

[Insert Procuring Entity]

Acknowledgment

[Format shall be based on the latest Rules on Notarial Practice]

OMNIBUS SWORN STATEMENT

[shall be submitted with the Bid]

REPUBLIC OF THE PHILIPPINES)

CITY/MUNICIPALITY OF _____) S.S.

AFFIDAVIT

I, [Name of Affiant], of legal age, [Civil Status], [Nationality], and residing at [Address of Affiant], after having been duly sworn in accordance with law, do hereby depose and state that:

1. *[Select one, delete the other:]*

[If a sole proprietorship:] I am the sole proprietor or authorized representative of [Name of Bidder] with office address at [address of Bidder];

[If a partnership, corporation, cooperative, or joint venture:] I am the duly authorized and designated representative of [Name of Bidder] with office address at [address of Bidder];

2. *[Select one, delete the other:]*

[If a sole proprietorship:] As the owner and sole proprietor, or authorized representative of [Name of Bidder], I have full power and authority to do, execute and perform any and all acts necessary to participate, submit the bid, and to sign and execute the ensuing contract for [Name of the Project] of the [Name of the Procuring Entity], as shown in the attached duly notarized Special Power of Attorney;

[If a partnership, corporation, cooperative, or joint venture:] I am granted full power and authority to do, execute and perform any and all acts necessary to participate, submit the bid, and to sign and execute the ensuing contract for [Name of the Project] of the [Name of the Procuring Entity], as shown in the attached [state title of attached document showing proof of authorization (e.g., duly notarized Secretary's Certificate, Board/Partnership Resolution, or Special Power of Attorney, whichever is applicable)];

3. [Name of Bidder] is not "blacklisted" or barred from bidding by the Government of the Philippines or any of its agencies, offices, corporations, or Local Government Units, foreign government/foreign or international financing institution whose blacklisting rules have been recognized by the Government Procurement Policy Board, **by itself or by relation, membership, association, affiliation, or controlling interest with another**

blacklisted person or entity as defined and provided for in the Uniform Guidelines on Blacklisting;

4. Each of the documents submitted in satisfaction of the bidding requirements is an authentic copy of the original, complete, and all statements and information provided therein are true and correct;
5. [Name of Bidder] is authorizing the Head of the Procuring Entity or its duly authorized representative(s) to verify all the documents submitted;

6. *[Select one, delete the rest:]*

[If a sole proprietorship:] The owner or sole proprietor is not related to the Head of the Procuring Entity, members of the Bids and Awards Committee (BAC), the Technical Working Group, and the BAC Secretariat, the head of the Project Management Office or the end-user unit, and the project consultants by consanguinity or affinity up to the third civil degree;

[If a partnership or cooperative:] None of the officers and members of [Name of Bidder] is related to the Head of the Procuring Entity, members of the Bids and Awards Committee (BAC), the Technical Working Group, and the BAC Secretariat, the head of the Project Management Office or the end-user unit, and the project consultants by consanguinity or affinity up to the third civil degree;

[If a corporation or joint venture:] None of the officers, directors, and controlling stockholders of [Name of Bidder] is related to the Head of the Procuring Entity, members of the Bids and Awards Committee (BAC), the Technical Working Group, and the BAC Secretariat, the head of the Project Management Office or the end-user unit, and the project consultants by consanguinity or affinity up to the third civil degree;

7. [Name of Bidder] complies with existing labor laws and standards; and
8. [Name of Bidder] is aware of and has undertaken the responsibilities as a Bidder in compliance with the Philippine Bidding Documents, which includes:
 - a. Carefully examining all of the Bidding Documents;
 - b. Acknowledging all conditions, local or otherwise, affecting the implementation of the Contract;
 - c. Making an estimate of the facilities available and needed for the contract to be bid, if any; and
 - d. Inquiring or securing Supplemental/Bid Bulletin(s) issued for the [Name of the

Project].

9. [Name of Bidder] did not give or pay directly or indirectly, any commission, amount, fee, or any form of consideration, pecuniary or otherwise, to any person or official, personnel or representative of the government in relation to any procurement project or activity.

10. In case advance payment was made or given, failure to perform or deliver any of the obligations and undertakings in the contract shall be sufficient grounds to constitute criminal liability for Swindling (Estafa) or the commission of fraud with unfaithfulness or abuse of confidence through misappropriating or converting any payment received by a person or entity under an obligation involving the duty to deliver certain goods or services, to the prejudice of the public and the government of the Philippines pursuant to Article 315 of Act No. 3815 s. 1930, as amended, or the Revised Penal Code.

IN WITNESS WHEREOF, I have hereunto set my hand this ___ day of ___, 20__ at _____, Philippines.

[Insert NAME OF BIDDER OR ITS AUTHORIZED REPRESENTATIVE]

[Insert signatory's legal capacity]

Affiant

[Jurat]

[Format shall be based on the latest Rules on Notarial Practice]

REPUBLIC OF THE PHILIPPINES)

CITY OF _____) S.S.

AFFIDAVIT OF SITE INSPECTION

I, (Representative of the Bidder) , of legal age, (civil status) , Filipino and residing at (Address of the Representative) , under oath, hereby depose and say:

1. That I am the (Position in the Bidder) of the (Name of the Bidder) , with office at (Address of the Bidder) ;
2. That I have inspected the site for (Name of the Contract) , located at (location of the Contract) ;
3. That I am making this statement as part of the requirement for the Technical Proposal of the (Name of the Bidder) for (Name of the Contract) .

IN FAITH WHEREOF, I hereby affix my signature this day of , 20 at , Philippines.

AFFIANT

Witness:

SUBSCRIBED AND SWORN TO before me this , day of 20 , affiant exhibiting to me his/her Community Tax Certificate No. issued on at , Philippines.

(Notary Public)

Until _____
PTR No. _____
Date _____
Place _____
TIN _____

Doc. No. _____
Page No. _____
Book No. _____
Series of _____

Bids and Awards Committee
Provincial Government of Camarines Norte

AFFIDAVIT OF AVAILABILITY OF KEY PERSONNEL AND EQUIPMENT

I, _____ of legal age, Filipino, married/single/widow, and, a resident of _____, owner/proprietor of _____ after having been duly sworn to in accordance with law, depose and declare;

1. That I/we have engage and contracted the service of Engr. _____ (herein called the Resident/Project Engineer), a Registered Civil Engineer with Professional License No. _____ issued on _____ and who has paid his Professional Tax for the Current Year _____;
2. That the said Engineer shall be appointed and designated as our Resident/Project Engineer to personally manage and supervise the construction.
3. That the said Engineer shall employ the best care, skill and ability in supervising the project in accordance with the Contract Agreement, contract plan, and other provisions embodied in the proposed contract;
4. That the said Engineer shall be personally present at the jobsite to supervise all the phase of the construction work at all time;
5. That all other key personnel are available for the project;
6. That equipment needed for the project, are likewise available;
7. That any willful violation on my/our part of the herein condition may prejudice my/our standing as a reliable contractor in future biddings in your office.

IN WITNESS WHEREOF, I have here unto set my hands this _____ day of _____, 20____ at _____, Philippines.

Affiant's Printed Name and Signature

WITNESSES:

SUBSCRIBED AND SWORN to before me this _____ day of _____, 20____ affiant exhibiting to me his/her Resident Certificate No.: _____ issued _____ at _____.

Notary Public

Doc No.: _____
Page No.: _____
Book No.: _____
Series of: _____

Bids and Awards Committee
 Provincial Government of Camarines Norte
 Provincial Capitol Building
 Daet, Camarines Norte

KEY PERSONNEL’S CERTIFICATE OF EMPLOYMENT

_____ *Date*

Dear Sir / Madame:

I am (Name of Nominee) a Licensed Engineer with Professional License No. _____ issued on (date of issuance) at (place of issuance) .

I hereby certify that (Name of Bidder) has engaged my services as (Designation) for (Name of the Contract) , if awarded to it.

As (Designation) , I supervised the following completed projects similar to the contract under bidding:

<u>NAME OF PROJECT</u>	<u>OWNER</u>	<u>COST</u>	<u>DATE COMPLETED</u>
_____	_____	_____	_____
_____	_____	_____	_____
_____	_____	_____	_____
_____	_____	_____	_____

At present, I am supervising the following projects:

<u>NAME OF PROJECT</u>	<u>OWNER</u>	<u>COST</u>	<u>DATE COMPLETED</u>
_____	_____	_____	_____
_____	_____	_____	_____
_____	_____	_____	_____
_____	_____	_____	_____

In case of my separation for any reason whatsoever from the above-mentioned Contractor, I shall notify the (Name of the Procuring Entity) at least twenty one (21) days before the effective date of my separation.

As (Designation), I know I will have to stay in the job site all the time to supervise and manage the Contract works to the best of my ability, and aware that I am authorized to handle only one (1) contract at a time.

I do not allow the use of my name for the purpose of enabling the above-mentioned Contractor to qualify for the Contract without any firm commitment on my part to assume the post of (Designation) therefore, if the contract is awarded to him since I understand that to do so will be a sufficient ground for my disqualification as (Designation) in any future (Name of the Procuring Entity) bidding or employment with any Contractor doing business with the (Name of the Procuring Entity).

(Signature of Engineer)

WITNESSES:

DRY SEAL

Republic of the Philippines)
_____) S.S.

SUBSCRIBED AND SWORN TO before me this _____ day of _____ 20__ affiant exhibiting to me his Residence Certificate No. _____ issued on _____ at _____.

NOTARY PUBLIC
PTR No.: _____
Issued at: _____
Issued on: _____
Until 31 December 20____

Doc. No.: _____;
Page No. : _____;
Book No.: _____;
Series of _____;



Republic of the Philippines
DEPARTMENT OF PUBLIC WORKS AND HIGHWAYS
OFFICE OF THE SECRETARY
Manila

OPD. 12 s/2016
10-10-2016

07 OCT 2016

DEPARTMENT ORDER)

NO. **197**)
Series of 2016)

SUBJECT: Revised Guidelines in the
Preparation of Approved Budget for
the Contract (ABC)

The following policies, rules and procedures relative to the preparation of the "Approved Budget for the Contract" (ABC) previously prescribed under Department Order No. 22, Series of 2015, are hereby revised/reiterated.

The ABC shall be prepared on the basis of the design plans for the project which has been duly approved by authorized officials in accordance with existing regulations.

All items of work to be used in preparing the ABC shall conform to the Standard Specifications for Highways, Bridges and Airports, revised 2013, Standard Specifications for Public Works Structures, 1995, and approved Special Specifications for the project.

The ABC shall be composed of the Direct Cost and the Indirect Cost.

A. The Direct Cost shall consist of the following:

A.1 Cost of materials to be used in doing the work item called for, which shall include, inter alia, the following:

A.1.1 Cost at source, including processing, crushing, stockpiling, loading, royalties, local taxes, construction and/or maintenance of haul roads, etc.

A.1.2 Expenses for hauling to project site.

A.1.3 Handling expenses.

A.1.4 Storage expenses.

A.1.5 Allowance for waste and/or losses, not to exceed 5% of materials requirement.

A.2 Cost of Labor:

A.2.1 Salaries and wages, as authorized by the Department of Labor and Employment.

A.2.2 Fringe benefits, such as vacation and sick leaves, benefits under the Workmen's Compensation Act, GSIS and/or SSS contributions, allowances, 13th month pay, bonuses, etc.

A.3 Equipment Expenses:

A.3.1 Rental rates of equipment shall be based on the prevailing "Association of Carriers and Equipment Lessors, (ACEL) Inc." approved for use by the DPWH (Presently it is the 2014 ACEL Rates). Rental rates of equipment not indicated in the ACEL booklet shall be taken from the rental rates prepared by the Bureau of Equipment. For simplicity in computation, the operated rental rates are preferred over the bare rental rates as the former includes operator's wages, fringe benefits, fuel, oil, lubricants and equipment maintenance. The make, model and capacity of the equipment should be indicated in the detailed unit cost analysis.

A.3.2 Mobilization and demobilization shall be treated as a separate pay item. It shall be computed based on the equipment requirements of the project stipulated in the proposal and contract booklet. Mobilization and demobilization shall not exceed 1% of the Estimated Direct Cost (EDC) of the civil works items. However, in special cases wherein requirements for mobilization/demobilization exceed 1%, an approval to utilize the actual computed mobilization/demobilization cost shall be secured from the concerned Undersecretary for Operations.

A.4 Cost for Permits, Clearances and other Government Taxes (i.e. MMDA Permit, LGU Permits, Bureau of Fire Protection Clearance, etc.) shall be included in the cost under Part B – Other General Requirements of the Program of Works (POW) and Estimate/ABC.

B. The Indirect Cost shall consist of the following:

B.1 Overhead Expenses – ranges from 7 – 11% of the EDC, which includes the following:

B.1.1 Engineering and Administrative Supervision.

B.1.2 Transportation allowances.

B.1.3 Office Expenses, e.g., for office equipment and supplies, power and water consumption, communication and maintenance.

B.1.4 Premium on Contractor's All Risk Insurance (CARI).

B.1.5 Financing Cost.

B.1.5.1 Premium on Bid Security

B.1.5.2 Premium on Performance Security

B.1.5.3 Premium on Surety for Advance Payment

B.1.5.4 Premium on Warranty Bond (one year)

B.2 Contingencies – ranges from 0.5 - 3% of the EDC. These include expenses for meetings, coordination with other stakeholders, billboards (excluding Project Billboard which is a pay item under the General Requirements), stages during ground breaking & inauguration ceremonies, and other unforeseen events.

- B.3 Miscellaneous Expenses – ranges from 0.5 - 1% of the EDC. These include laboratory tests for quality control and plan preparation.
- B.4 Contractor's Profit Margin – shall be 8% of the EDC for projects above P5Million and 10% for projects P5Million and below.
- B.5 VAT Component – shall be 5% of the sum of the EDC, OCM and Profit.
- B.6 The following items shall not be subjected to OCM and Profit mark-up:
- B.6.1 Mobilization and demobilization
 - B.6.2 Provision of Service Vehicle
 - B.6.3 Permits and Clearances
- B.7 The following non-civil works items shall not be subjected to OCM mark-up:
- B.7.1 Field/Laboratory Office & Living Quarters (Rental Basis)
 - B.7.2 Furnishing of Furniture, Laboratory Equipment, Survey Equipment and Consumables
 - B.7.3 Assistance to the Engineers
 - B.7.4 Photographs
 - B.7.5 Health and Safety
 - B.7.6 Traffic Management
 - B.7.7 Environmental Compliance
 - B.7.8 Communication Equipment, etc.

NOTE: For the percentage to be used for Nos. B.1, B.2 and B.3, see OCM (Overhead, Contingencies and Miscellaneous) column in the tabulation below.

ESTIMATED DIRECT COST (EDC)	INDIRECT COST % FOR OCM AND PROFIT		TOTAL INDIRECT COST % FOR OCM AND PROFIT
	OCM (% OF EDC)	PROFIT (% OF EDC)	
Up to P5Million	15	10	25
Above P5M up to P50M	12	8	20
Above P50M up to P150M	10	8	18
Above P150M	8	8	16

C. The prescribed format for the calculation of the ABC is shown in Attachment "A".

- C.1 Instructions for filling-up the format:

- C.1.1 Columns (1) to (4) are self-explanatory.
- C.1.2 Column (5) is the EDC of the work item as calculated and reflected in the cost analysis prepared by the Estimator.
- C.1.3 Columns (6) and (7) are the mark-ups in percent for OCM and profit.
- C.1.4 Column (8) is the total mark-up, which is the sum of the percentages under columns (6) and (7).
- C.1.5 Column (9) is the Peso value of the total mark-up. It is determined by multiplying the total mark-up on percent in column (8) with the EDC (column 5).
- C.1.6 Column (10) is the VAT component which is 5% of the sum of columns (5) and (9).
- C.1.7 Column (11) is the total estimated Indirect Cost which is the sum of columns (9) and (10).
- C.1.8 Column (12) is the total estimated Total Cost or the sum of columns (5) and (11).
- C.1.9 Column (13) is the unit cost for each item of works, determined by dividing the estimated Total Cost in column (12) by its total quantity in column (3).

C.2 Procedures in preparing, processing and corresponding signatories specified under Department Order No. 163, Series of 2015 in the preparation of Program of Work (POW) and Approved Budget for the Contract (ABC) shall be observed.

Since the ABC is to be compared with the Contractor's bid and is the ceiling for acceptable bid prices in accordance with the provision of R.A. 9184, the ABC should be based on the approved Bidding Documents for the contract which contain the same work items and quantities as those to be used by the contractors in preparing their bid.

DPWH estimators shall continuously update their information/statistics on market prices of all construction inputs submitted for incorporation in the quarterly Construction Materials Price Database (CMPD). All assumptions in generating the estimate should be shown in the cost analysis.

In all cases, estimates for special items of work (SPL) should be accompanied with plans and specifications, methods of construction, measurements and payments duly approved by the Bureau of Research and Standards (BRS).

This Order shall take effect immediately and shall supersede Department Order No. 22, Series of 2015.



MARK A. VILLAR
Acting Secretary

6.1 WRD/PCA

Department of Public Works and Highways
Office of the Secretary



WIN6W01961



