



**PROVINCIAL GOVERNMENT OF CAMARINES NORTE  
DAET**

**CONSTRUCTION OF 2<sup>ND</sup> FLR  
BRGY HALL OF MALACBANG**

**Brgy. Malacbang,  
Paracale, Camarines Norte**

**April 20, 2023**

# Preface

These Philippine Bidding Documents (PBDs) for the procurement of Infrastructure Projects (hereinafter referred to also as the “Works”) through Competitive Bidding have been prepared by the Government of the Philippines for use by all branches, agencies, departments, bureaus, offices, or instrumentalities of the government, including government-owned and/or -controlled corporations, government financial institutions, state universities and colleges, local government units, and autonomous regional government. The procedures and practices presented in this document have been developed through broad experience, and are for mandatory use in projects that are financed in whole or in part by the Government of the Philippines or any foreign government/foreign or international financing institution in accordance with the provisions of the 2016 revised Implementing Rules and Regulations (IRR) of Republic Act (RA) No. 9184.

The PBDs are intended as a model for admeasurements (unit prices or unit rates in a bill of quantities) types of contract, which are the most common in Works contracting.

The Bidding Documents shall clearly and adequately define, among others: (i) the objectives, scope, and expected outputs and/or results of the proposed contract; (ii) the eligibility requirements of Bidders; (iii) the expected contract duration; and (iv) the obligations, duties, and/or functions of the winning Bidder.

Care should be taken to check the relevance of the provisions of the PBDs against the requirements of the specific Works to be procured. If duplication of a subject is inevitable in other sections of the document prepared by the Procuring Entity, care must be exercised to avoid contradictions between clauses dealing with the same matter.

Moreover, each section is prepared with notes intended only as information for the Procuring Entity or the person drafting the Bidding Documents. They shall not be included in the final documents. The following general directions should be observed when using the documents:

- a. All the documents listed in the Table of Contents are normally required for the procurement of Infrastructure Projects. However, they should be adapted as necessary to the circumstances of the particular Project.
- b. Specific details, such as the “*name of the Procuring Entity*” and “*address for bid submission,*” should be furnished in the Instructions to Bidders, Bid Data Sheet, and Special Conditions of Contract. The final documents should contain neither blank spaces nor options.
- c. This Preface and the footnotes or notes in italics included in the Invitation to Bid, BDS, General Conditions of Contract, Special Conditions of Contract, Specifications, Drawings, and Bill of Quantities are not part of the text of the final document, although they contain instructions that the Procuring Entity should strictly follow.
- d. The cover should be modified as required to identify the Bidding Documents as to the names of the Project, Contract, and Procuring Entity, in addition to date of issue.

- e. Modifications for specific Procurement Project details should be provided in the Special Conditions of Contract as amendments to the Conditions of Contract. For easy completion, whenever reference has to be made to specific clauses in the Bid Data Sheet or Special Conditions of Contract, these terms shall be printed in bold typeface on Sections I (Instructions to Bidders) and III (General Conditions of Contract), respectively.
- f. For guidelines on the use of Bidding Forms and the procurement of Foreign-Assisted Projects, these will be covered by a separate issuance of the Government Procurement Policy Board.

# TABLE OF CONTENTS

<b>GLOSSARY OF .....</b>	<b>5</b>
<b>TERMS, ABBREVIATIONS, AND ACRONYMS .....</b>	<b>5</b>
<b>SECTION I. INVITATION TO BID .....</b>	<b>8</b>
<b>SECTION II. INSTRUCTIONS TO BIDDERS.....</b>	<b>11</b>
1. Scope of Bid .....	12
2. Funding Information.....	12
3. Bidding Requirements .....	12
4. Corrupt, Fraudulent, Collusive, Coercive, and Obstructive Practices .....	13
5. Eligible Bidders .....	13
6. Origin of Associated Goods .....	13
7. Subcontracts .....	13
8. Pre-Bid Conference .....	14
9. Clarification and Amendment of Bidding Documents .....	14
10. Documents Comprising the Bid: Eligibility and Technical Components.....	14
11. Documents Comprising the Bid: Financial Component.....	15
12. Alternative Bids.....	15
13. Bid Prices .....	15
14. Bid and Payment Currencies .....	16
15. Bid Security.....	16
16. Sealing and Marking of Bids.....	16
17. Deadline for Submission of Bids.....	16
18. Opening and Preliminary Examination of Bids.....	16
19. Detailed Evaluation and Comparison of Bids .....	17
20. Post Qualification .....	17
21. Signing of the Contract.....	17
<b>SECTION III. BID DATA SHEET .....</b>	<b>18</b>
<b>SECTION IV. GENERAL CONDITIONS OF CONTRACT .....</b>	<b>20</b>
1. Scope of Contract .....	21
2. Sectional Completion of Works .....	21
3. Possession of Site .....	21
4. The Contractor's Obligations .....	21
5. Performance Security .....	22

6.	Site Investigation Reports.....	22
7.	Warranty.....	22
8.	Liability of the Contractor.....	22
9.	Termination for Other Causes.....	22
10.	Dayworks.....	23
11.	Program of Work.....	23
12.	Instructions, Inspections and Audits.....	23
13.	Advance Payment.....	23
14.	Progress Payments.....	23
15.	Operating and Maintenance Manuals.....	23
<b>SECTION V. SPECIAL CONDITIONS OF CONTRACT.....</b>		<b>25</b>
<b>SECTION VI. SPECIFICATIONS.....</b>		<b>27</b>
ITEM 103 – STRUCTURE EXCAVATION.....		28
ITEM 403 – METAL STRUCTURES.....		41
ITEM 404 – REINFORCING STEEL.....		84
ITEM 405 – STRUCTURAL CONCRETE.....		87
ITEM 409 – WELDED STRUCTURAL STEEL.....		98
ITEM 1013 – CORRUGATED METAL ROOFING.....		118
ITEM 1014 - PREPAINTED METAL SHEETS.....		123
ITEM 1032 - PAINTING, VARNISHING AND OTHER RELATED WORKS.....		127
<b>SECTION VII. DRAWINGS.....</b>		<b>129</b>
<b>SECTION VIII. BILL OF QUANTITIES.....</b>		<b>142</b>
<b>SECTION IX. CHECKLIST OF TECHNICAL AND FINANCIAL DOCUMENTS.....</b>		<b>144</b>
<b>BID FORM.....</b>		<b>147</b>
<b>BID SECURING DECLARATION.....</b>		<b>149</b>
<b>CONTRACT AGREEMENT FORM.....</b>		<b>150</b>
<b>OMNIBUS SWORN STATEMENT.....</b>		<b>152</b>
<b>AFFIDAVIT OF SITE INSPECTION.....</b>		<b>155</b>
<b>AFFIDAVIT OF AVAILABILITY OF KEY PERSONNEL AND EQUIPMENT... </b>		<b>156</b>
<b>KEY PERSONNEL’S CERTIFICATE OF EMPLOYMENT.....</b>		<b>157</b>
<b>PERFORMANCE SECURING DECLARATION.....</b>		<b>159</b>
<b>DPWH DEPARTMENT ORDER 197.....</b>		<b>161</b>

# *Glossary of Terms, Abbreviations, and Acronyms*

**ABC** – Approved Budget for the Contract.

**ARCC** – Allowable Range of Contract Cost.

**BAC** – Bids and Awards Committee.

**Bid** – A signed offer or proposal to undertake a contract submitted by a bidder in response to and in consonance with the requirements of the bidding documents. Also referred to as *Proposal* and *Tender*. (2016 revised IRR, Section 5[c])

**Bidder** – Refers to a contractor, manufacturer, supplier, distributor and/or consultant who submits a bid in response to the requirements of the Bidding Documents. (2016 revised IRR, Section 5[d])

**Bidding Documents** – The documents issued by the Procuring Entity as the bases for bids, furnishing all information necessary for a prospective bidder to prepare a bid for the Goods, Infrastructure Projects, and/or Consulting Services required by the Procuring Entity. (2016 revised IRR, Section 5[e])

**BIR** – Bureau of Internal Revenue.

**BSP** – Bangko Sentral ng Pilipinas.

**CDA** – Cooperative Development Authority.

**Consulting Services** – Refer to services for Infrastructure Projects and other types of projects or activities of the GOP requiring adequate external technical and professional expertise that are beyond the capability and/or capacity of the GOP to undertake such as, but not limited to: (i) advisory and review services; (ii) pre-investment or feasibility studies; (iii) design; (iv) construction supervision; (v) management and related services; and (vi) other technical services or special studies. (2016 revised IRR, Section 5[i])

**Contract** – Refers to the agreement entered into between the Procuring Entity and the Supplier or Manufacturer or Distributor or Service Provider for procurement of Goods and Services; Contractor for Procurement of Infrastructure Projects; or Consultant or Consulting Firm for Procurement of Consulting Services; as the case may be, as recorded in the Contract Form signed by the parties, including all attachments and appendices thereto and all documents incorporated by reference therein.

**Contractor** – is a natural or juridical entity whose proposal was accepted by the Procuring Entity and to whom the Contract to execute the Work was awarded. Contractor as used in these Bidding Documents may likewise refer to a supplier, distributor, manufacturer, or consultant.

**CPI** – Consumer Price Index.

**DOLE** – Department of Labor and Employment.

**DTI** – Department of Trade and Industry.

**Foreign-funded Procurement or Foreign-Assisted Project** – Refers to procurement whose funding source is from a foreign government, foreign or international financing institution as specified in the Treaty or International or Executive Agreement. (2016 revised IRR, Section 5[b]).

**GFI** – Government Financial Institution.

**GOCC** – Government-owned and/or –controlled corporation.

**Goods** – Refer to all items, supplies, materials and general support services, except Consulting Services and Infrastructure Projects, which may be needed in the transaction of public businesses or in the pursuit of any government undertaking, project or activity, whether in the nature of equipment, furniture, stationery, materials for construction, or personal property of any kind, including non-personal or contractual services such as the repair and maintenance of equipment and furniture, as well as trucking, hauling, janitorial, security, and related or analogous services, as well as procurement of materials and supplies provided by the Procuring Entity for such services. The term “related” or “analogous services” shall include, but is not limited to, lease or purchase of office space, media advertisements, health maintenance services, and other services essential to the operation of the Procuring Entity. (2016 revised IRR, Section 5[r])

**GOP** – Government of the Philippines.

**Infrastructure Projects** – Include the construction, improvement, rehabilitation, demolition, repair, restoration or maintenance of roads and bridges, railways, airports, seaports, communication facilities, civil works components of information technology projects, irrigation, flood control and drainage, water supply, sanitation, sewerage and solid waste management systems, shore protection, energy/power and electrification facilities, national buildings, school buildings, hospital buildings, and other related construction projects of the government. Also referred to as *civil works or works*. (2016 revised IRR, Section 5[u])

**LGUs** – Local Government Units.

**NFCC** – Net Financial Contracting Capacity.

**NGA** – National Government Agency.

**PCAB** – Philippine Contractors Accreditation Board.

**PhilGEPS** - Philippine Government Electronic Procurement System.

**Procurement Project** – refers to a specific or identified procurement covering goods, infrastructure project or consulting services. A Procurement Project shall be described, detailed, and scheduled in the Project Procurement Management Plan prepared by the agency which shall be consolidated in the procuring entity's Annual Procurement Plan. (GPPB Circular No. 06-2019 dated 17 July 2019)

**PSA** – Philippine Statistics Authority.

**SEC** – Securities and Exchange Commission.

**SLCC** – Single Largest Completed Contract.

**UN** – United Nations.



## ***Section I. Invitation to Bid***



REPUBLIC OF THE PHILIPPINES  
PROVINCE OF CAMARINES NORTE  
Daet

**BIDS AND AWARDS COMMITTEE**

**Invitation to Bid for the Construction of 2<sup>nd</sup> Floor Brgy. Hall of Malacbang,  
Brgy. Malacbang, Paracale, Camarines Norte**

1. The *Provincial Government of Camarines Norte*, through the *20% Development Fund CY 2023* intends to apply the sum of *One Million Nine Hundred Ninety-Four Thousand Six Hundred Forty-Three Pesos and Ninety-Three Centavos (P1,994,643.93)* being the Approved Budget for the Contract (ABC) to payments under the contract for the *Construction of 2<sup>nd</sup> Floor Brgy. Hall of Malacbang, Brgy. Malacbang, Paracale, Camarines Norte*. Bids received in excess of the ABC shall be automatically rejected at bid opening.
2. The *Provincial Government of Camarines Norte* now invites bids for the *Construction of 8.00m x 7.50m 2<sup>nd</sup> Floor Expansion and Storage*. Completion of the Works is required *150 CD*. Bidders should have completed a contract similar to the Project. The description of an eligible bidder is contained in the Bidding Documents, particularly, in Section II (Instructions to Bidders).
3. Bidding will be conducted through open competitive bidding procedures using non-discretionary "pass/fail" criterion as specified in the 2016 Revised Implementing Rules and Regulations (IRR) of Republic Act 9184 (RA 9184), otherwise known as the "Government Procurement Reform Act."
4. Bidders may obtain further information from the *Provincial Government of Camarines Norte* and inspect the Bidding Documents at the address given below from *8:00a.m. to 5:00p.m., Monday to Friday*.
5. A complete set of Bidding Documents may be acquired by interested bidders on *April 20 – May 16, 2023* at the *Provincial Capitol Building, Daet, Camarines Norte* and from the website of the *Philippine Government Electronic Procurement System (PhilGEPS)* upon payment of the applicable fee for the Bidding Documents, pursuant to the latest Guidelines issued by the GPPB, in the amount of *Five Thousand Pesos (P5,000.00)*. The Procuring Entity shall allow the bidder to present its proof of payment for the fees in person.
6. The *Provincial Government of Camarines Norte* will hold a Pre-Bid Conference on *May 2, 2023, 2:00p.m.* at the *new BAC Conference Office, at the back of Agro-Sports Center, J. Lukban Street, Daet, Camarines Norte*, which shall be open to prospective bidders.
7. Bids must be duly received by the BAC Secretariat at the address below on or before *May 16, 2023 at 1:30p.m.* Late bids shall not be accepted.
8. All bids must be accompanied by a bid security in any of the acceptable forms and in the amount stated in **ITB Clause 15**.
9. Bid opening shall be on *May 16, 2023, 2:00 p.m.* at the *new BAC Conference Office, at the back of Agro-Sports Center, J. Lukban Street, Daet, Camarines Norte*. Bids will be opened in the presence of the bidders' representatives who choose to attend the activity.

10. The *Provincial Government of Camarines Norte* reserves the right to reject any and all bids, declare a failure of bidding, or not award the contract at any time prior to contract award in accordance with Section 35 and 41 of RA 9184 of the revised IRR of RA 9184 without thereby incurring any liability to the affected bidder or bidders.
11. For further information, please refer to:  
*MRS. MERCEDES M. ALFUERTE*  
*Provincial Budget Officer / BAC Chairperson*  
*Provincial Capitol Bldg., Daet, Camarines Norte*  
*(054) 885-1474*
12. You may visit the website:  
*Philippine Government Electronic Procurement System (PhilGEPS)*

  
*MERCEDES M. ALFUERTE*  
*Provincial Budget Officer / BAC Chairperson*

## ***Section II. Instructions to Bidders***

## 1. Scope of Bid

The Procuring Entity, *[indicate name]* invites Bids for the *[insert Procurement Project]*, with Project Identification Number *[indicate number]*.

*[Note: The Project Identification Number is assigned by the Procuring Entity based on its own coding scheme and is not the same as the PhilGEPS reference number, which is generated after the posting of the bid opportunity on the PhilGEPS website.]*

The Procurement Project (referred to herein as “Project”) is for the construction of Works, as described in Section VI (Specifications).

## 2. Funding Information

2.1. The GOP through the source of funding as indicated below for *[indicate funding year]* in the amount of *[indicate amount]*.

2.2. The source of funding is:

*[If an early procurement activity, select one and delete others:]*

- a. NGA, the National Expenditure Program.
- b. GOCC and GFIs, the proposed Corporate Operating Budget.
- c. LGUs, the proposed Local Expenditure Program.

*[If not an early procurement activity, select one and delete others:]*

- a. NGA, the General Appropriations Act or Special Appropriations.
- b. GOCC and GFIs, the Corporate Operating Budget.
- c. LGUs, the Annual or Supplemental Budget, as approved by the Sanggunian.

## 3. Bidding Requirements

The Bidding for the Project shall be governed by all the provisions of RA No. 9184 and its 2016 revised IRR, including its Generic Procurement Manual and associated policies, rules and regulations as the primary source thereof, while the herein clauses shall serve as the secondary source thereof.

Any amendments made to the IRR and other GPPB issuances shall be applicable only to the ongoing posting, advertisement, or invitation to bid by the BAC through the issuance of a supplemental or bid bulletin.

*The Bidder, by the act of submitting its Bid, shall be deemed to have inspected the site, determined the general characteristics of the contracted Works and the conditions for this Project, such as the location and the nature of the work; (b) climatic conditions; (c) transportation facilities; (c) nature and condition of the terrain, geological conditions*

*at the site communication facilities, requirements, location and availability of construction aggregates and other materials, labor, water, electric power and access roads; and (d) other factors that may affect the cost, duration and execution or implementation of the contract, project, or work and examine all instructions, forms, terms, and project requirements in the Bidding Documents.*

#### **4. Corrupt, Fraudulent, Collusive, Coercive, and Obstructive Practices**

The Procuring Entity, as well as the Bidders and Contractors, shall observe the highest standard of ethics during the procurement and execution of the contract. They or through an agent shall not engage in corrupt, fraudulent, collusive, coercive, and obstructive practices defined under Annex “I” of the 2016 revised IRR of RA No. 9184 or other integrity violations in competing for the Project.

#### **5. Eligible Bidders**

5.1. Only Bids of Bidders found to be legally, technically, and financially capable will be evaluated.

5.2. The Bidder must have an experience of having completed a Single Largest Completed Contract (SLCC) that is similar to this Project, equivalent to at least fifty percent (50%) of the ABC adjusted, if necessary, by the Bidder to current prices using the PSA’s CPI, except under conditions provided for in Section 23.4.2.4 of the 2016 revised IRR of RA No. 9184.

A contract is considered to be “similar” to the contract to be bid if it has the major categories of work stated in the **BDS**.

5.3. For Foreign-funded Procurement, the Procuring Entity and the foreign government/foreign or international financing institution may agree on another track record requirement, as specified in the Bidding Document prepared for this purpose.

5.4. The Bidders shall comply with the eligibility criteria under Section 23.4.2 of the 2016 IRR of RA No. 9184.

#### **6. Origin of Associated Goods**

There is no restriction on the origin of Goods other than those prohibited by a decision of the UN Security Council taken under Chapter VII of the Charter of the UN.

#### **7. Subcontracts**

7.1. The Bidder may subcontract portions of the Project to the extent allowed by the Procuring Entity as stated herein, but in no case more than fifty percent (50%) of the Project.

The Procuring Entity has prescribed that:  
[Select one, delete other/s]

- a. Subcontracting is allowed. The portions of Project and the maximum percentage allowed to be subcontracted are indicated in the **BDS**, which shall not exceed fifty percent (50%) of the contracted Works.
  - b. Subcontracting is not allowed.
- 7.1. *[If Procuring Entity has determined that subcontracting is allowed during the bidding , state:]* The Bidder must submit together with its Bid the documentary requirements of the subcontractor(s) complying with the eligibility criteria stated in **ITB** Clause 5 in accordance with Section 23.4 of the 2016 revised IRR of RA No. 9184 pursuant to Section 23.1 thereof.
- 7.2. *[If subcontracting is allowed during the contract implementation stage, state:]* The Supplier may identify its subcontractor during the contract implementation stage. Subcontractors identified during the bidding may be changed during the implementation of this Contract. Subcontractors must submit the documentary requirements under Section 23.1 of the 2016 revised IRR of RA No. 9184 and comply with the eligibility criteria specified in **ITB** Clause 5 to the implementing or end-user unit.
- 7.3. Subcontracting of any portion of the Project does not relieve the Contractor of any liability or obligation under the Contract. The Supplier will be responsible for the acts, defaults, and negligence of any subcontractor, its agents, servants, or workmen as fully as if these were the Contractor's own acts, defaults, or negligence, or those of its agents, servants, or workmen.

## **8. Pre-Bid Conference**

The Procuring Entity will hold a pre-bid conference for this Project on the specified date and time and either at its physical address *{[insert if applicable]}* and/or through videoconferencing/webcasting} as indicated in paragraph 6 of the **IB**.

## **9. Clarification and Amendment of Bidding Documents**

Prospective bidders may request for clarification on and/or interpretation of any part of the Bidding Documents. Such requests must be in writing and received by the Procuring Entity, either at its given address or through electronic mail indicated in the **IB**, at least ten (10) calendar days before the deadline set for the submission and receipt of Bids.

## **10. Documents Comprising the Bid: Eligibility and Technical Components**

- 10.1. The first envelope shall contain the eligibility and technical documents of the Bid as specified in **Section IX. Checklist of Technical and Financial Documents**.
- 10.2. If the eligibility requirements or statements, the bids, and all other documents for submission to the BAC are in foreign language other than English, it must

be accompanied by a translation in English, which shall be authenticated by the appropriate Philippine foreign service establishment, post, or the equivalent office having jurisdiction over the foreign bidder's affairs in the Philippines. For Contracting Parties to the Apostille Convention, only the translated documents shall be authenticated through an apostille pursuant to GPPB Resolution No. 13-2019 dated 23 May 2019. The English translation shall govern, for purposes of interpretation of the bid.

- 10.3. A valid PCAB License is required, and in case of joint ventures, a valid special PCAB License, and registration for the type and cost of the contract for this Project. Any additional type of Contractor license or permit shall be indicated in the **BDS**.
- 10.4. A List of Contractor's key personnel (e.g., Project Manager, Project Engineers, Materials Engineers, and Foremen) assigned to the contract to be bid, with their complete qualification and experience data shall be provided. These key personnel must meet the required minimum years of experience set in the **BDS**.
- 10.5. A List of Contractor's major equipment units, which are owned, leased, and/or under purchase agreements, supported by proof of ownership, certification of availability of equipment from the equipment lessor/vendor for the duration of the project, as the case may be, must meet the minimum requirements for the contract set in the **BDS**.

## **11. Documents Comprising the Bid: Financial Component**

- 11.1. The second bid envelope shall contain the financial documents for the Bid as specified in **Section IX. Checklist of Technical and Financial Documents**.
- 11.2. Any bid exceeding the ABC indicated in paragraph 1 of the **IB** shall not be accepted.
- 11.3. For Foreign-funded procurement, a ceiling may be applied to bid prices provided the conditions are met under Section 31.2 of the 2016 revised IRR of RA No. 9184.

## **12. Alternative Bids**

Bidders shall submit offers that comply with the requirements of the Bidding Documents, including the basic technical design as indicated in the drawings and specifications. Unless there is a value engineering clause in the **BDS**, alternative Bids shall not be accepted.

## **13. Bid Prices**

All bid prices for the given scope of work in the Project as awarded shall be considered as fixed prices, and therefore not subject to price escalation during contract implementation, except under extraordinary circumstances as determined by the NEDA and approved by the GPPB pursuant to the revised Guidelines for Contract Price Escalation guidelines.



## 14. Bid and Payment Currencies

14.1. Bid prices may be quoted in the local currency or tradeable currency accepted by the BSP at the discretion of the Bidder. However, for purposes of bid evaluation, Bids denominated in foreign currencies shall be converted to Philippine currency based on the exchange rate as published in the BSP reference rate bulletin on the day of the bid opening.

14.2. *Payment of the contract price shall be made in:*

*[Select one, delete other/s]*

a. Philippine Pesos.

b. *[indicate currency if procurement involves a foreign-denominated bid as allowed by the Procuring Entity, which shall be tradeable or acceptable by the BSP.]*

## 15. Bid Security

15.1. The Bidder shall submit a Bid Securing Declaration or any form of Bid Security in the amount indicated in the **BDS**, which shall be not less than the percentage of the ABC in accordance with the schedule in the **BDS**.

15.2. The Bid and bid security shall be valid until *[indicate date]*. Any bid not accompanied by an acceptable bid security shall be rejected by the Procuring Entity as non-responsive.

## 16. Sealing and Marking of Bids

Each Bidder shall submit one copy of the first and second components of its Bid.

The Procuring Entity may request additional hard copies and/or electronic copies of the Bid. However, failure of the Bidders to comply with the said request shall not be a ground for disqualification.

If the Procuring Entity allows the submission of bids through online submission to the given website or any other electronic means, the Bidder shall submit an electronic copy of its Bid, which must be digitally signed. An electronic copy that cannot be opened or is corrupted shall be considered non-responsive and, thus, automatically disqualified.

## 17. Deadline for Submission of Bids

The Bidders shall submit on the specified date and time and either at its physical address or through online submission as indicated in paragraph 7 of the **IB**.

## 18. Opening and Preliminary Examination of Bids

- 18.1. The BAC shall open the Bids in public at the time, on the date, and at the place specified in paragraph 9 of the **IB**. The Bidders' representatives who are present shall sign a register evidencing their attendance. In case videoconferencing, webcasting or other similar technologies will be used, attendance of participants shall likewise be recorded by the BAC Secretariat.

In case the Bids cannot be opened as scheduled due to justifiable reasons, the rescheduling requirements under Section 29 of the 2016 revised IRR of RA No. 9184 shall prevail.

- 18.2. The preliminary examination of Bids shall be governed by Section 30 of the 2016 revised IRR of RA No. 9184.

## **19. Detailed Evaluation and Comparison of Bids**

- 19.1. The Procuring Entity's BAC shall immediately conduct a detailed evaluation of all Bids rated "*passed*" using non-discretionary pass/fail criteria. The BAC shall consider the conditions in the evaluation of Bids under Section 32.2 of 2016 revised IRR of RA No. 9184.
- 19.2. If the Project allows partial bids, all Bids and combinations of Bids as indicated in the **BDS** shall be received by the same deadline and opened and evaluated simultaneously so as to determine the Bid or combination of Bids offering the lowest calculated cost to the Procuring Entity. Bid Security as required by **ITB** Clause 16 shall be submitted for each contract (lot) separately.
- 19.3. In all cases, the NFCC computation pursuant to Section 23.4.2.6 of the 2016 revised IRR of RA No. 9184 must be sufficient for the total of the ABCs for all the lots participated in by the prospective Bidder.

## **20. Post Qualification**

Within a non-extendible period of five (5) calendar days from receipt by the Bidder of the notice from the BAC that it submitted the Lowest Calculated Bid, the Bidder shall submit its latest income and business tax returns filed and paid through the BIR Electronic Filing and Payment System (eFPS), and other appropriate licenses and permits required by law and stated in the **BDS**.

## **21. Signing of the Contract**

The documents required in Section 37.2 of the 2016 revised IRR of RA No. 9184 shall form part of the Contract. Additional Contract documents are indicated in the **BDS**.

## *Section III. Bid Data Sheet*

# Bid Data Sheet

ITB Clause																			
5.2	For this purpose, contracts similar to the Project refer to contracts which have the same major categories of work, which shall be: <b><i>Building Construction</i></b>																		
7.1	<i>Subcontracting is not allowed.</i>																		
10.3	<i>No further instructions.</i>																		
10.4	The key personnel must meet the required minimum years of experience set below: <table border="1" style="width: 100%; border-collapse: collapse;"> <thead> <tr> <th style="text-align: left;"><u>Key Personnel</u></th> <th style="text-align: center;"><u>General Experience</u></th> <th style="text-align: center;"><u>Relevant Experience</u></th> </tr> </thead> <tbody> <tr> <td><b>Project Manager</b></td> <td style="text-align: center;"><b>one (1)</b></td> <td style="text-align: center;"><b>one (1)</b></td> </tr> <tr> <td><b>Project Engineer</b></td> <td style="text-align: center;"><b>one (1)</b></td> <td style="text-align: center;"><b>one (1)</b></td> </tr> <tr> <td><b>Materials Engineer</b></td> <td style="text-align: center;"><b>one (1)</b></td> <td style="text-align: center;"><b>one (1)</b></td> </tr> </tbody> </table>	<u>Key Personnel</u>	<u>General Experience</u>	<u>Relevant Experience</u>	<b>Project Manager</b>	<b>one (1)</b>	<b>one (1)</b>	<b>Project Engineer</b>	<b>one (1)</b>	<b>one (1)</b>	<b>Materials Engineer</b>	<b>one (1)</b>	<b>one (1)</b>						
<u>Key Personnel</u>	<u>General Experience</u>	<u>Relevant Experience</u>																	
<b>Project Manager</b>	<b>one (1)</b>	<b>one (1)</b>																	
<b>Project Engineer</b>	<b>one (1)</b>	<b>one (1)</b>																	
<b>Materials Engineer</b>	<b>one (1)</b>	<b>one (1)</b>																	
10.5	The minimum major equipment requirements are the following: <table border="1" style="width: 100%; border-collapse: collapse;"> <thead> <tr> <th style="text-align: left;"><u>Equipment</u></th> <th style="text-align: center;"><u>Capacity</u></th> <th style="text-align: center;"><u>Number of Units</u></th> </tr> </thead> <tbody> <tr> <td>1. Welding machine</td> <td></td> <td style="text-align: center;">1</td> </tr> <tr> <td>2. Hoisting machine</td> <td></td> <td style="text-align: center;">1</td> </tr> <tr> <td>3. Bagger Mixer</td> <td></td> <td style="text-align: center;">1</td> </tr> <tr> <td>4. Concrete Vibrator</td> <td></td> <td style="text-align: center;">1</td> </tr> <tr> <td>5. Grinder</td> <td></td> <td style="text-align: center;">1</td> </tr> </tbody> </table>	<u>Equipment</u>	<u>Capacity</u>	<u>Number of Units</u>	1. Welding machine		1	2. Hoisting machine		1	3. Bagger Mixer		1	4. Concrete Vibrator		1	5. Grinder		1
<u>Equipment</u>	<u>Capacity</u>	<u>Number of Units</u>																	
1. Welding machine		1																	
2. Hoisting machine		1																	
3. Bagger Mixer		1																	
4. Concrete Vibrator		1																	
5. Grinder		1																	
12	<b><i>Not Applicable</i></b>																		
15.1	The bid security shall be in the form of a Bid Securing Declaration or any of the following forms and amounts: a. The amount of not less than <b><u>PhP 40,000.00</u></b> , if bid security is in cash, cashier's/manager's check, bank draft/guarantee or irrevocable letter of credit;  b. The amount of not less than <b><u>PhP 100,000.00</u></b> if bid security is in Surety Bond.																		
19.2	<b><i>Not Applicable</i></b>																		
20	<b><i>No further instructions.</i></b>																		
21	Additional contract documents relevant to the Project that may be required by existing laws and/or the Procuring Entity, such as PERT/CPM, construction schedule and S- curve, manpower schedule, construction methods, equipment utilization schedule, construction safety and health program approved by the DOLE, and other acceptable tools of project scheduling.																		

## ***Section IV. General Conditions of Contract***

## 1. **Scope of Contract**

This Contract shall include all such items, although not specifically mentioned, that can be reasonably inferred as being required for its completion as if such items were expressly mentioned herein. All the provisions of RA No. 9184 and its 2016 revised IRR, including the Generic Procurement Manual, and associated issuances, constitute the primary source for the terms and conditions of the Contract, and thus, applicable in contract implementation. Herein clauses shall serve as the secondary source for the terms and conditions of the Contract.

This is without prejudice to Sections 74.1 and 74.2 of the 2016 revised IRR of RA No. 9184 allowing the GPPB to amend the IRR, which shall be applied to all procurement activities, the advertisement, posting, or invitation of which were issued after the effectivity of the said amendment.

## 2. **Sectional Completion of Works**

If sectional completion is specified in the **Special Conditions of Contract (SCC)**, references in the Conditions of Contract to the Works, the Completion Date, and the Intended Completion Date shall apply to any Section of the Works (other than references to the Completion Date and Intended Completion Date for the whole of the Works).

## 3. **Possession of Site**

4.1. The Procuring Entity shall give possession of all or parts of the Site to the Contractor based on the schedule of delivery indicated in the **SCC**, which corresponds to the execution of the Works. If the Contractor suffers delay or incurs cost from failure on the part of the Procuring Entity to give possession in accordance with the terms of this clause, the Procuring Entity's Representative shall give the Contractor a Contract Time Extension and certify such sum as fair to cover the cost incurred, which sum shall be paid by Procuring Entity.

4.2. If possession of a portion is not given by the above date, the Procuring Entity will be deemed to have delayed the start of the relevant activities. The resulting adjustments in contract time to address such delay may be addressed through contract extension provided under Annex "E" of the 2016 revised IRR of RA No. 9184.

## 4. **The Contractor's Obligations**

The Contractor shall employ the key personnel named in the Schedule of Key Personnel indicating their designation, in accordance with **ITB** Clause 10.3 and specified in the **BDS**, to carry out the supervision of the Works.

The Procuring Entity will approve any proposed replacement of key personnel only if their relevant qualifications and abilities are equal to or better than those of the personnel listed in the Schedule.

## **5. Performance Security**

- 5.1. Within ten (10) calendar days from receipt of the Notice of Award from the Procuring Entity but in no case later than the signing of the contract by both parties, the successful Bidder shall furnish the performance security in any of the forms prescribed in Section 39 of the 2016 revised IRR.
- 5.2. The Contractor, by entering into the Contract with the Procuring Entity, acknowledges the right of the Procuring Entity to institute action pursuant to RA No. 3688 against any subcontractor be they an individual, firm, partnership, corporation, or association supplying the Contractor with labor, materials and/or equipment for the performance of this Contract.

## **6. Site Investigation Reports**

The Contractor, in preparing the Bid, shall rely on any Site Investigation Reports referred to in the SCC supplemented by any information obtained by the Contractor.

## **7. Warranty**

- 7.1. In case the Contractor fails to undertake the repair works under Section 62.2.2 of the 2016 revised IRR, the Procuring Entity shall forfeit its performance security, subject its property(ies) to attachment or garnishment proceedings, and perpetually disqualify it from participating in any public bidding. All payables of the GOP in his favor shall be offset to recover the costs.
- 7.2. The warranty against Structural Defects/Failures, except that occasioned-on force majeure, shall cover the period from the date of issuance of the Certificate of Final Acceptance by the Procuring Entity. Specific duration of the warranty is found in the SCC.

## **8. Liability of the Contractor**

Subject to additional provisions, if any, set forth in the SCC, the Contractor's liability under this Contract shall be as provided by the laws of the Republic of the Philippines.

If the Contractor is a joint venture, all partners to the joint venture shall be jointly and severally liable to the Procuring Entity.

## **9. Termination for Other Causes**

Contract termination shall be initiated in case it is determined *prima facie* by the Procuring Entity that the Contractor has engaged, before, or during the implementation of the contract, in unlawful deeds and behaviors relative to contract acquisition and implementation, such as, but not limited to corrupt, fraudulent, collusive, coercive, and obstructive practices as stated in ITB Clause 4.

## **10. Dayworks**

Subject to the guidelines on Variation Order in Annex “E” of the 2016 revised IRR of RA No. 9184, and if applicable as indicated in the **SCC**, the Dayworks rates in the Contractor’s Bid shall be used for small additional amounts of work only when the Procuring Entity’s Representative has given written instructions in advance for additional work to be paid for in that way.

## **11. Program of Work**

11.1. The Contractor shall submit to the Procuring Entity’s Representative for approval the said Program of Work showing the general methods, arrangements, order, and timing for all the activities in the Works. The submissions of the Program of Work are indicated in the **SCC**.

11.2. The Contractor shall submit to the Procuring Entity’s Representative for approval an updated Program of Work at intervals no longer than the period stated in the **SCC**. If the Contractor does not submit an updated Program of Work within this period, the Procuring Entity’s Representative may withhold the amount stated in the **SCC** from the next payment certificate and continue to withhold this amount until the next payment after the date on which the overdue Program of Work has been submitted.

## **12. Instructions, Inspections and Audits**

The Contractor shall permit the GOP or the Procuring Entity to inspect the Contractor’s accounts and records relating to the performance of the Contractor and to have them audited by auditors of the GOP or the Procuring Entity, as may be required.

## **13. Advance Payment**

The Procuring Entity shall, upon a written request of the Contractor which shall be submitted as a Contract document, make an advance payment to the Contractor in an amount not exceeding fifteen percent (15%) of the total contract price, to be made in lump sum, or at the most two installments according to a schedule specified in the **SCC**, subject to the requirements in Annex “E” of the 2016 revised IRR of RA No. 9184.

## **14. Progress Payments**

The Contractor may submit a request for payment for Work accomplished. Such requests for payment shall be verified and certified by the Procuring Entity’s Representative/Project Engineer. Except as otherwise stipulated in the **SCC**, materials and equipment delivered on the site but not completely put in place shall not be included for payment.

## **15. Operating and Maintenance Manuals**

15.1. If required, the Contractor will provide “as built” Drawings and/or operating and maintenance manuals as specified in the **SCC**.



- 15.2. If the Contractor does not provide the Drawings and/or manuals by the dates stated above, or they do not receive the Procuring Entity's Representative's approval, the Procuring Entity's Representative may withhold the amount stated in the SCC from payments due to the Contractor.

## ***Section V. Special Conditions of Contract***

# Special Conditions of Contract

GCC Clause	
2	<i>Not Applicable</i>
3.1	<i>upon receipt of the Notice to Proceed</i>
6	The site investigation reports are: <b><i>Present condition of the actual project site</i></b>
7.2	<i>[In case of permanent structures, such as buildings of types 4 and 5 as classified under the National Building Code of the Philippines and other structures made of steel, iron, or concrete which comply with relevant structural codes (e.g., DPWH Standard Specifications), such as, but not limited to, steel/concrete bridges, flyovers, aircraft movement areas, ports, dams, tunnels, filtration and treatment plants, sewerage systems, power plants, transmission and communication towers, railway system, and other similar permanent structures:] Fifteen (15) years.</i>
10	Dayworks are applicable at the rate shown in the Contractor's original Bid.
11.1	The Contractor shall submit the Program of Work to the Procuring Entity's Representative within 5 <i>working days</i> of delivery of the Notice of Award.
11.2	The period between Program of Work updates is thirty (30) days.  The amount to be withheld for late submission of an updated Program of Work is 1% of progress billing.
13	The amount of the advance payment is <b><i>15% of the total contract price.</i></b>
14	<b><i>Materials and equipment delivered on the site but not completely put in place shall NOT be included for payment.</i></b>
15.1	The date by which "as built" drawings are required is 15-30 days upon completion date.
15.2	The amount to be withheld for failing to produce "as built" drawings by the date required is 1% of the final contract amount in Philippine pesos.

## *Section VI. Specifications*

## ITEM 103 - STRUCTURE EXCAVATION

### 103.1 Description

This Item shall consist of the necessary excavation for foundation of bridge, culverts, underdrains, and other structures not otherwise provided for in the Specifications. Except as otherwise provided for pipe culverts, the backfilling of completed structures and the disposal of all excavated surplus materials, shall be in accordance with these Specifications and in reasonably close conformity with the Plans or as established by the Engineer.

This Item shall include necessary diverting of live streams, bailing, pumping, draining, sheeting, bracing, and necessary construction of cribs and cofferdams, and furnishing the materials therefore, and the subsequent removal of cribs and cofferdams and the placing of all necessary backfill.

It shall also include the furnishing and placing of approved foundation fill material to replace unsuitable material encountered below the foundation elevation of structures.

No allowances will be made for classification of different types of material encountered.

### 103.2 Construction Requirements

#### 103.2.1 Clearing and Grubbing

#### 103.2.2 Excavation

General, all structures. The Contractor shall notify the Engineer sufficiently in advance of the beginning of any excavation so that cross-sectional elevations and measurements may be taken on the undisturbed ground. The natural ground adjacent to the structure shall not be disturbed without permission of the Engineer.

Trenches or foundation pits for structures or structure footing shall be excavated to the lines and grades or elevations shown on the Plans or as staked by the Engineer. They shall be of sufficient size to permit the placing of structures or structure footing of the full width and length shown. The elevations of the bottoms of footings, as shown on the Plans, shall be considered as approximate only and the Engineer may order, in writing, such changes in dimensions or elevations of footings as may be deemed necessary, to secure a satisfactory foundation.

Boulders, logs and other objectionable materials encountered in excavation shall be removed.

After each excavation is completed, the Contractor shall notify the Engineer to that effect and no footing, bedding material or pipe culvert shall be placed until the Engineer has approved the depth of excavation and the character of the foundation material.

Structures other than pipe culverts. All rocks or other hard foundation materials shall be cleaned all loose materials, and cut to a firm surface, either level, stepped, or serrated as directed by the Engineer. All seams or crevices shall be cleaned and grouted. All loose and disintegrated rocks and thin strata shall be removed. When the footing is to rest on material other than rock, excavation to final grade shall not be made until just before the footing is to be placed. When the foundation material is soft or mucky or otherwise unsuitable, as determined by the Engineer, the Contractor shall remove the unsuitable material and backfill with approved granular material. This foundation fill shall be placed and compacted in 150 mm (6 inches) layers up to the foundation elevation.

When foundation piles are used, the excavation of each pit shall be completed before the piles are driven and any placing of foundation fill shall be done after the piles are driven. After the driving is completed, all loose and displaced materials shall be removed, leaving a smooth, solid bed to receive the footing.

Pipe Culverts. The width of the pipe trench shall be sufficient to permit satisfactory jointing of the pipe and thorough tamping of the bedding material under and around the pipe.

Where rock, harden, or other unyielding material is encountered, it shall be removed below the foundation grade for a depth of at least 300 mm or 4 mm for each 100 mm of fill over the top of pipe, whichever is greater, but not exceed three-quarters of the vertical inside diameter of the pipe. The width of the excavation shall be at least 300 mm (12 inches) greater than the horizontal outside diameter of the pipe. The excavation below grade shall be backfilled with selected fine compressible material, such as silty clay or loam, and lightly compacted in layers not over 150 mm (6 inches) in uncompacted depth to form a uniform but yielding foundation.

Where a firm foundation is not encountered at the grade established, due to soft, spongy, or other unstable soil such as unstable soil under the pipe and for a width of at least one diameter on each side of the pipe shall be removed to the depth directed by the Engineer and replaced with approved granular foundation fill material properly compacted to provide adequate support for the pipe, unless other special construction methods are called for on the Plans.

The foundation surface shall provide a firm foundation of uniform density throughout the length of the culvert and, if directed by the Engineer, shall be cambered in the direction parallel to the pipe centerline.

Where pipe culverts are to be placed in trenches excavated in embankments, the excavation of each trench shall be performed after the embankment has been constructed to a plane parallel to the proposed profile grade and to such height above the bottom of the pipe as shown on the Plans or directed by the Engineer.

### 103.2.3 Utilization of Excavated Material

All excavated material, so far as suitable, shall be utilized as backfill or embankment. The surplus materials shall be disposed off in such manner as not to obstruct the stream or otherwise impair the efficiency or appearance of the structure. No excavated materials shall be

deposited at any times so as to endanger the partly finished structure.

#### 103.2.4 Cofferdams

uitable and practically watertight cofferdams shall be used wherever water-bearing strata are encountered above the elevation of the bottom of the excavation. If requested, the Contractor shall submit drawings showing his proposed method of cofferdam construction, as directed by the Engineer.

Cofferdams or cribs for foundation construction shall in general, be carried well below the bottoms of the footings and shall be well braced and as nearly watertight as practicable. In general, the interior dimensions of cofferdams shall be such as to give sufficient clearance for the construction of forms and the inspection of their exteriors, and to permit pumping outside of the forms. Cofferdams or cribs which are tilted or moved laterally during the process of sinking shall be righted or enlarged so as to provide the necessary clearance.

When conditions are encountered which, as determined by the Engineer, render it impracticable to dewater the foundation before placing the footing, the Engineer may require the construction of a concrete for such a thickness as to resist any possible uplift. The concrete for such seal shall be placed as shown on the Plans or directed by the Engineer. The foundation shall then be dewatered and the footing placed. When weighted cribs are employed and the mass is utilized to overcome partially the hydrostatic pressure acting against the bottom of the foundation seal, special anchorage such as dowels or keys shall be provided to transfer the entire mass of the crib to the foundation seal. When a foundation seal is placed under water. The cofferdams shall be vented or ported at low water level as directed.

Cofferdams shall be constructed so as to protect green concrete against damage from sudden rising of the stream and to prevent damage to the foundation by erosion. No timber or bracing shall be left in cofferdams or cribs in such a way as to extend into substructure masonry, without written permission from the Engineer.

Any pumping that may be permitted from the interior of any foundation enclosure shall be done in such a manner as to preclude the possibility of any portion of the concrete material being carried away. Any pumping required during the placing of concrete, or for a period of at least 24 hours thereafter, shall be done from a suitable sump located outside the concrete forms. Pumping to dewater a sealed cofferdam shall not commence forms. Pumping to dewater a sealed cofferdam shall not commence until the seal has set sufficiently to withstand the hydrostatic pressure.

Unless otherwise provided, cofferdams or cribs, with all sheeting and bracing involved therewith, shall be removed by the Contractor after the completion of the substructure. Removal shall be effected in such manner as not to disturb or mar finished masonry.

#### 103.2.5 Preservation of Channel

Unless otherwise permitted, no excavation shall be made outside of caissons, cribs, cofferdams, or sheet piling, and the natural stream bed adjacent to structure shall not be disturbed without permission from the Engineer. If any excavation or dredging is made at the side of the structure before caissons, cribs, or cofferdams are sunk in place, the Contractor shall, after the foundation base is in place, backfill all such excavations to the original ground surface or stream bed with material satisfactory to the Engineer.

#### 103.2.6 Backfill and Embankment for Structures Other than Pipe Culverts

Excavated areas around structures shall be backfilled with free draining granular material approved by the Engineer and placed in horizontal layers not over 150 mm (6inches) in thickness, to the level of the original ground surface. Each layer shall be moistened or dried as required and thoroughly compacted with mechanical tampers.

In placing backfills or embankment, the material shall be placed simultaneously in so far as possible to approximately the same elevation on both sides of an abutment, pier or wall. If conditions require placing backfill or embankment appreciably higher on one side shall not be placed until masonry has been place for 14 days, or until tests made by the laboratory under the supervision of the Engineer establishes that the masonry has attained sufficient strength to withstand any pressure created by the methods used and materials placed without damage or strain beyond a safe factor.

Backfill or embankment shall not be placed behind the walls of concrete culverts or abutments or rigid frame structures until the top slab is placed and cured. Backfill and embankment behind abutments held at the top by the superstructure, and behind the sidewalls of culverts, shall be carried up simultaneously behind opposite abutments or sidewalls.

All embankments adjacent to structures shall be constructed in horizontal layers and compacted as prescribed in Subsection 104.3.3 except that mechanical tampers may be used for the required compaction. Special care shall be taken to prevent any wedging action against the structure and slopes bounding or within the areas to be filled shall be benched or serrated to prevent wedge action. The placing of embankment and the benching of slopes shall continue in such a manner that at all times there will be horizontal berm of thoroughly compacted material for a distance at least equal to the height of the abutment or wall to the backfilled against except insofar as undisturbed material obtrudes upon the area.

Broken rock or coarse sand and gravel shall be provided for a drainage filter at weepholes as shown on the Plans.

#### 103.2.7 Bedding, Backfill, and Embankment for Pipe Culverts

Bedding, Backfill and Embankment for pipe culverts shall be done in accordance with Item 500, Pipe Culverts and Storm Drains.

#### 103.3 Method of Measurement



### 103.3.1 Structure Excavation

The volume of excavation to be paid for will be the number of cubic metres measured in original position of material acceptably excavated on conformity with the Plans as directed by the Engineer, but in no case, except as noted, will any of the following volumes be included in the measurement for payment.

The volume outside of vertical planes 450 mm (18inches) outside of and parallel to the neat lines of footings and the inside walls of pipe and pipe-arch culverts at their widest horizontal dimensions. The volume of excavation for culvert and sections outside the vertical plane for culverts stipulated in (1) above.

The volume outside of neat lines of underdrains as shown on the Plans, and outside the limits of foundation fill as ordered by the Engineer.

The volume included within the staked limits of the roadway excavation, contiguous channel changes, ditches, etc., for which payment is otherwise provided in the Specification,

Volume of water or other liquid resulting from construction operations and which can be pumped or drained away.

The volume of any excavation performed prior to the taking of elevations and measurements of the undisturbed ground.

The volume of any material rehandled ,except that where the Plans indicate or the Engineer directs the excavation after embankment has been placed and except that when installation of pipe culverts by the imperfect trench method specified in Item 500 is required, the volume of material re-excavated as directed will be included.

The volume of excavation for footings ordered at a depth more than 1.5m (60inches) below the lowest elevation for such footings shown on the original Contract Plans, unless the Bill of Quantities contains a pay item for excavation ordered below the elevations shown on the Plans for individual footings.

### 103.3.3 Free Draining Backfill

The Contractor shall supply, place and compact free-draining backfill to the lines, grades and dimensions and in the locations shown on the Drawings or instructed.

Free draining backfill shall be obtained from approved sources and shall be well graded with a maximum dimension of 150 mm, and not more than 5% smaller than 0.075 mm. Freed draining backfill placed within 1 m of concrete structures shall not contain rocks larger than 75 mm in maximum dimension and shall be placed carefully so as not to damage the structure.

The material shall be handled and placed in such a manner as to prevent segregation.

Free draining backfill shall be deposited in horizontal layers not more than 150 mm thick after being compacted, and shall be thoroughly wetted for the purpose of compaction, as determined by the Engineer, and the moisture content shall be uniform throughout the layer.

Free draining backfill shall be compacted with 2 passes of a vibratory plate compactor having a minimum static mass of 100 kg.

### 103.3.5 Basis of Payment

The accepted quantities, measured as prescribed in Section 103.3, shall be paid for at the contract unit price for each of the particular pay items listed below that is included in the Bill of Quantities. The payment shall constitute full compensation for the removal and disposal of excavated materials including all labor, equipment, tools and incidentals necessary to complete the work prescribed in this Item, except as follows:

Any excavation for footings ordered at a depth more than 1.5m below the lowest elevation shown on the original Contract Plans will be paid for as provided in Part K, Measurement and Payment, unless a pay item for excavation ordered below Plan elevation appears in the Bill of Quantities.

Concrete will be measured and paid for as provided under Item 405, Structural Concrete. Any roadway or borrow excavation required in excess of the quantity excavated for structures will be measured and paid for as provided under Item 102.

Payment will be made under:

Pay Item Number	Description	Unit of Measurement
103 (1)	Structure Excavation	Cubic Meter
103 (2)	Backfill (from structural excavation)	Cubic Meter
103 (3)	Foundation Fill	Cubic Meter
103 (4)	Excavation ordered below Plan elevation	Cubic Meter
103 (6)	Pipe culverts and drain excavation	Cubic Meter

## **ITEM 104 – EMBANKMENT**

### **104.1 Description**

This Item shall consist of the construction of embankment in accordance with this Specification and in conformity with the lines, grades and dimensions shown on the Plans or established by the Engineer.

## 104.2 Material Requirements

Embankments shall be constructed of suitable materials, in consonance with the following definitions:

1. Suitable Material – Material which is acceptable in accordance with the Contract and which can be compacted in the manner specified in this Item. It can be common material or rock.

Selected Borrow, for topping – soil of such gradation that all particles will pass a sieve with 75 mm (3 inches) square openings and not more than 15 mass percent will pass the 0.075 mm (No. 200) sieve, as determined by AASHTO T 11. The material shall have a plasticity index of not more than 6 as determined by AASHTO T 90 and a liquid limit of not more than 30 as determined by AASHTO T 89.

2. Unsuitable Material – Material other than suitable materials such as:
  - (a) Materials containing detrimental quantities of organic materials, such as grass, roots and sewerage.
  - (b) Organic soils such as peat and muck.

- (c) Soils with liquid limit exceeding 80 and/or plasticity index exceeding 55.
- (d) Soils with a natural water content exceeding 100%.
- (e) Soils with very low natural density, 800 kg/m<sup>3</sup> or lower.
- (f) Soils that cannot be properly compacted as determined by the Engineer.

### **104.3 Construction Requirements**

#### **104.3.1 General**

Prior to construction of embankment, all necessary clearing and grubbing in that area shall have been performed in conformity with Item 100, Clearing and Grubbing.

Embankment construction shall consist of constructing roadway embankments, including preparation of the areas upon which they are to be placed; the construction of dikes within or adjacent to the roadway; the placing and compacting of approved material within roadway areas where unsuitable material has been removed; and the placing and compacting of embankment material in holes, pits, and other depressions within the roadway area.

Embankments and backfills shall contain no muck, peat, sod, roots or other deleterious matter. Rocks, broken concrete or other solid, bulky materials shall not be placed in embankment areas where piling is to be placed or driven.

Where shown on the Plans or directed by the Engineer, the surface of the existing ground shall be compacted to a depth of 150 mm (6 inches) and to the specified requirements of this Item.

Where provided on the Plans and Bill of Quantities the top portions of the roadbed in both cuts and embankments, as indicated, shall consist of selected borrow for topping from excavations.

#### **104.3.2 Methods of Construction**

Where there is evidence of discrepancies on the actual elevations and that shown on the Plans, a preconstruction survey referred to the datum plane used in the approved Plan shall be undertaken by the Contractor under the control of the Engineer to serve as basis for the computation of the actual volume of the embankment materials.

When embankment is to be placed and compacted on hillsides, or when new embankment is to be compacted against existing embankments, or when embankment is built one-half width at a time, the existing slopes that are steeper than 3:1 when measured at right angles to the roadway shall be continuously benched over those areas as the work is brought up in layers. Benching will be subject to the Engineer's approval and shall be of sufficient width to permit operation of placement and compaction equipment. Each horizontal cut shall begin at the intersection of the original ground and the vertical sides of the previous cuts. Material thus excavated shall be placed and compacted along with the embankment material in accordance with the procedure described in this Section.

Unless shown otherwise on the Plans or special Provisions, where an embankment of less than 1.2 m (4 feet) below subgrade is to be made, all sod and vegetable matter shall be removed from the surface upon which the embankment is to be placed, and the cleared surfaced shall be completely broken up by plowing, scarifying, or steeping to a minimum depth of 150 mm except as provided in Subsection 102.2.2. This area shall then be compacted as provided in Subsection 104.3.3. Sod not required to be removed shall be thoroughly disc harrowed or scarified before construction of embankment. Wherever a compacted road surface containing granular materials lies within 900 mm (36 inches) of the subgrade, such old road surface shall be scarified to a depth of at least 150 mm (6 inches) whenever directed by the Engineer. This scarified materials shall then be compacted as provided in Subsection 104.3.3.

When shoulder excavation is specified, the roadway shoulders shall be excavated to the depth and width shown on the Plans. The shoulder material shall be removed without disturbing the adjacent existing base course material, and all excess excavated materials shall be disposed off as provided in Subsection 102.2.3. If necessary, the areas shall be compacted before being backfilled.

Roadway embankment of earth material shall be placed in horizontal layers not exceeding 200 mm (8 inches), loose measurement, and shall be compacted as specified before the next layer is placed. However, thicker layer maybe placed if vibratory roller with high compactive effort is used provided that density requirement is attained and as approved by the Engineer. Trial section to this effect must be conducted and approved by the Engineer. Effective spreading equipment shall be used on each lift to obtain uniform thickness as determined in the trial section prior to compaction. As the compaction of each layer progresses, continuous leveling and manipulating will be required to assure uniform density. Water shall be added or removed, if necessary, in order to obtain the required density. Removal of water shall be accomplished through aeration by plowing, blading, discing, or other methods satisfactory to the Engineer.

Where embankment is to be constructed across low swampy ground that will not support the mass of trucks or other hauling equipment, the lower part of the fill may be constructed by dumping successive loads in a uniformly distributed layer of a thickness not greater than necessary to support the hauling equipment while placing subsequent layers.

When excavated material contains more than 25 mass percent of rock larger than 150 mm in greatest diameter and cannot be placed in layers of the thickness prescribed without crushing, pulverizing or further breaking down the pieces resulting from excavation methods, such materials may be placed on the embankment in layers not exceeding in thickness the approximate average size of the larger rocks, but not greater than 600 mm (24 inches).

Even though the thickness of layers is limited as provided above, the placing of individual rocks and boulders greater than 600 mm in diameter will be permitted provided that when placed, they do not exceed 1200 mm (48 inches) in height and provided they are carefully distributed, with the interstices filled with finer material to form a dense and compact mass.

Each layer shall be leveled and smoothed with suitable leveling equipment and by distribution of spalls and finer fragments of earth. Lifts of material containing more than 25 mass percent of rock larger than 150 mm in greatest dimensions shall not be constructed above an elevation 300 mm ( 12 inches) below the finished subgrade. The balance of the embankment shall be composed of suitable material smoothed and placed in layers not exceeding 200 mm (8 inches) in loose thickness and compacted as specified for embankments.

Dumping and rolling areas shall be kept separate, and no lift shall be covered by another until compaction complies with the requirements of Subsection 104.3.3.

Hauling and leveling equipment shall be so routed and distributed over each layer of the fill in such a manner as to make use of compaction effort afforded thereby and to minimize rutting and uneven compaction.

### **104.3.3 Compaction**

#### **Compaction Trials**

Before commencing the formation of embankments, the Contractor shall submit in writing to the Engineer for approval his proposals for the compaction of each type of fill material to be used in the works. The proposals shall include the relationship between the types of compaction equipment, and the number of passes required and the method of adjusting moisture content. The Contractor shall carry out full scale compaction trials on areas not less than 10 m wide and 50 m long as required by the Engineer and using his proposed procedures or such amendments thereto as may be found necessary to satisfy the Engineer that all the specified requirements regarding compaction can be consistently achieved. Compaction trials with the main types of fill material to be used in the works shall be completed before work with the corresponding materials will be allowed to commence.

Throughout the periods when compaction of earthwork is in progress, the Contractor shall adhere to the compaction procedures found from compaction trials for each type of material being compacted, each type of compaction equipment employed and each degree of compaction specified.

## **Earth**

The Contractor shall compact the material placed in all embankment layers and the material scarified to the designated depth below subgrade in cut sections, until a uniform density of not less than 95 mass percent of the maximum dry density determined by AASHTO T 99 Method C, is attained, at a moisture content determined by Engineer to be suitable for such density. Acceptance of compaction may be based on adherence to an approved roller pattern developed as set forth in Item 106, Compaction Equipment and Density Control Strips.

The Engineer shall during progress of the Work, make density tests of compacted material in accordance with AASHTO T 191, T 205, or other approved field density tests, including the use of properly calibrated nuclear testing devices. A correction for coarse particles may be made in accordance with AASHTO T 224. If, by such tests, the Engineer determines that the specified density and moisture conditions have not been attained, the Contractor shall perform additional work as may be necessary to attain the specified conditions.

At least one group of three in-situ density tests shall be carried out for each 500 m of each layer of compacted fill.

## **Rock**

Density requirements will not apply to portions of embankments constructed of materials which cannot be tested in accordance with approved methods.

Embankment materials classified as rock shall be deposited, spread and leveled the full width of the fill with sufficient earth or other fine material so deposited to fill the interstices to produce a dense compact embankment. In addition, one of the rollers, vibrators, or compactors meeting the requirements set forth in Subsection 106.2.1, Compaction Equipment, shall compact the embankment full width with a minimum of three complete passes for each layer of embankment.

### **104.3.4 Protection of Roadbed During Construction**

During the construction of the roadway, the roadbed shall be maintained in such condition that it will be well drained at all times. Side ditches or gutters emptying from cuts to

embankments or otherwise shall be so constructed as to avoid damage to embankments by erosion.

#### **104.3.5 Protection of Structure**

If embankment can be deposited on one side only of abutments, wing walls, piers or culvert headwalls, care shall be taken that the area immediately adjacent to the structure is not compacted to the extent that it will cause overturning of, or excessive pressure against the structure. When noted on the Plans, the fill adjacent to the end bent of a bridge shall not be placed higher than the bottom of the backfill of the bent until the superstructure is in place. When embankment is to be placed on both sides of a concrete wall or box type structure, operations shall be so conducted that the embankment is always at approximately the same elevation on both sides of the structure.

#### **104.3.6 Rounding and Warping Slopes**

Rounding-Except in solid rock, the tops and bottoms of all slopes, including the slopes of drainage ditches, shall be rounded as indicated on the Plans. A layer of earth overlaying rock shall be rounded above the rock as done in earth slopes.

Warping-adjustments in slopes shall be made to avoid injury in standing trees or marring of weathered rock, or to harmonize with existing landscape features, and the transition to such adjusted slopes shall be gradual. At intersections of cuts and fills, slopes shall be adjusted and warped to flow into each other or into the natural ground surfaces without noticeable break.

#### **104.3.7 Finishing Roadbed and Slopes**

After the roadbed has been substantially completed, the full width shall be conditioned by removing any soft or other unstable material that will not compact properly or serve the intended purpose. The resulting areas and all other low sections, holes or depressions shall be brought to grade with suitable selected material. Scarifying, blading, dragging, rolling, or other methods of work shall be performed or used as necessary to provide a thoroughly compacted roadbed shaped to the grades and cross-sections shown on the Plans or as staked by the Engineer.

All earth slopes shall be left with roughened surfaces but shall be reasonably uniform, without any noticeable break, and in reasonably close conformity with the Plans or other surfaces indicated on the Plans or as staked by the Engineer, with no variations therefrom readily discernible as viewed from the road.

#### **104.3.8 Serrated Slopes**



Cut slopes in rippable material (soft rock) having slope ratios between 0.75:1 and 2:1 shall be constructed so that the final slope line shall consist of a series of small horizontal steps. The step rise and tread dimensions shall be shown on the Plans. No scaling shall be performed on the stepped slopes except for removal of large rocks which will obviously be a safety hazard if they fall into the ditchline or roadway.

#### **104.3.9 Earth Berms**

When called for in the Contract, permanent earth berms shall be constructed of well graded materials with no rocks having a diameter greater than 0.25 the height of the berm. When local material is not acceptable, acceptable material shall be imported, as directed by the Engineer.

##### Compacted Berm

Compacted berm construction shall consist of moistening or drying and placing material as necessary in locations shown on the drawings or as established by the Engineer. Material shall contain no frozen material, roots, sod, or other deleterious materials. Contractor shall take precaution to prevent material from escaping over the embankment slope. Shoulder surface beneath berm will be roughened to provide a bond between the berm and shoulder when completed. The Contractor shall compact the material placed until at least 90 mass percent of the maximum density is obtained as determined by AASHTO T 99, Method C. The cross-section of the finished compacted berm shall reasonably conform to the typical cross-section as shown on the Plans.

##### Uncompacted Berm

Uncompacted berm construction shall consist of drying, if necessary and placing material in locations shown on the Plans or as established by the Engineer. Material shall contain no frozen material, roots, sod or other deleterious materials. Contractor shall take precautions to prevent material from escaping over the embankment slope.

#### **104.4 Method of Measurement**

The quantity of embankment to be paid for shall be the volume of material compacted in place, accepted by the Engineer and formed with material obtained from any source.

Material from excavation per Item 102 which is used in embankment and accepted by the Engineer will be paid under Embankment and such payment will be deemed to include the cost of excavating, hauling, stockpiling and all other costs incidental to the work.

Material for Selected Borrow topping will be measured and paid for under the same conditions specified in the preceding paragraph.

**104.5 Basis of Payment**

The accepted quantities, measured as prescribed in Section 104.4, shall be paid for at the Contract unit price for each of the Pay Items listed below that is included in the Bill of Quantities. The payment shall continue full compensation for placing and compacting all materials including all labor, equipment, tools and incidentals necessary to complete the work prescribed in this Item.

Payment will be made under:

Pay Item Number	Description	Unit of Measurement
104 (1)	Embankment	Cubic Meter
104 (2)	Selected, Borrow for topping, Case 1	Cubic Meter
104 (3)	Selected Borrow for topping, Case 2	Cubic Meter
104 (4)	Earth Berm	Meter

**ITEM 403 – METAL STRUCTURES**

**403.1 Description**

This work shall consist of steel structures and the steel structure portions of composite structures, constructed in reasonably close conformity with the lines, grades and dimensions shown on the Plans or established by the Engineer.

The work will include the furnishing, fabricating, hauling, erecting, welding and painting of structural metals called for in the Special Provision or shown on the Plans. Structural metals will include structural steel, rivet, welding, special and alloy steels, steel forgings and castings and iron castings. This work will also include any incidental metal construction not otherwise provided for, all in accordance with these Specifications, Plans and Special Provisions.

## **403.2 Material Requirements**

Materials shall meet the requirements of Item 712, Structural Metal; Item 409, Welded Structural Steel, and Item 409, Welded Structural Steel; and Item 709, Paints.

## **403.3 Construction Requirements**

### **403.3.1 Inspection**

The Contractor shall give the Engineer at least fifteen (15) days notice prior to the beginning of work at the mill or shop, so that the required inspection may be made. The term “mill” means any rolling mill, shop or foundry where material for the work is to be manufactured or fabricated. No material shall be rolled or fabricated until said inspection has been provided.

The Contractor shall furnish the Engineer with copies of the certified mill reports of the structural steel, preferably before but not later than the delivery of the steel to the job site.

The Contractor shall furnish all facilities for inspection and the Engineer shall be allowed free access to the mill or shop and premises at all times. The Contractor shall furnish, without charge, all labor, machinery, material and tools necessary to prepare test specimens.

Inspection at the mill or shop is intended as a means of facilitating the work and avoiding errors and it is expressly understood that it will not relieve the Contractor from any responsibility for imperfect material or workmanship and the necessity for replacing same. The acceptance of any material or finished member at the mill or shop by the Engineer shall not preclude their subsequent rejection if found defective before final acceptance of the work. Inspection of welding will be in accordance with the provision of Section 5 of the “Standard Code for Arc and Gas Welding in Building Construction” of the American Welding Society.

### **403.3.2 Stock Material Control**

When so specified in the Contract, stock material shall be segregated into classes designated as “identified” or “unidentified”. Identified material is material which can be positively identified as having been rolled from a given heat for which certified mill test can be produced. Unidentified material shall include all other general stock materials. When it is proposed to use unidentified material, the Engineer shall be notified of such intention at least fifteen (15) days in advance of commencing fabrication to permit sampling and testing. When so indicated or directed, the Contractor shall select such material as he wishes to use from stock, and place it in such position that it will be accessible for inspection and sampling. The Contractor shall select identified material from as few heat numbers as possible, and furnish

the certified mill test reports on each of such heat numbers. Two samples shall be taken from each heat number as directed, one for a tension test and one for a bend test.

In the case of unidentified stock, the Engineer may, at his discretion, select any number of random test specimens.

Each bin from which rivets or bolts are taken shall subject to random test. Five rivets or bolts may be selected by the Engineer from each bin for test purposes.

Structural material, either plain or fabricated, shall be stored above the ground upon platforms, skids, or other supports. It shall be kept free from dirt, grease, or other foreign matter, and shall be protected as far as practicable from corrosion.

### **403.3.3 Fabrication**

These Specifications apply to riveted, bolted and welded construction. The Contractor may, however, with approval of the Engineer, substitute high tensile strength steel bolts equivalent to the rivets in any connection.

Workmanship and finish shall be in accordance with the best general practice in modern bridge shops. Portions of the work exposed to view shall be finished neatly. Shearing, flame cutting, and chipping shall be done carefully and accurately.

Structural material, either plain or fabricated, shall be stored above the ground upon platforms, skids or other supports. It shall be kept free from dirt, grease or other foreign matter, and shall be protected as far as practicable from corrosion.

Rolled material before being laid off or worked must be straight. If straightening is necessary, it shall be done by methods that will not injure the metal. Sharp kinks and bends will be cause for rejection of the material.

Preparation of material shall be in accordance with AWS (American Welding Society) D 1.1, paragraph 3.2 as modified by AASHTO Standard Specification for Welding of Structural Steel Highway Bridges.

### **403.3.4 Finishing and Shaping**

Finished members shall be true to line and free from twists, bends and open joints.

#### **1. Edge Planing**

Sheared edges of plates more than 15.9 mm in thickness and carrying calculated stresses shall be planed to a depth of 6.3 mm. Re-entrant cuts shall be filleted before cutting.

#### **2. Facing of Bearing Surfaces**

The surface finish of bearing and based plates and other bearing surfaces that are to come in contact with each other or with concrete shall meet the American

National Standards Institute surface roughness requirements as defined in ANSI B-46.1-47, Surface Roughness Waviness and Lay, Part I:

Steel slabs	ANSI 2,000
Heavy plates in contact in shoes to Be welded	ANSI 1,000
Milled ends of compression members, stiffeners and fillers	ANSI 500
Bridge rollers and rockers	ANSI 250
Pins and pin holes	ANSI 125
Sliding bearings	ANSI 125

### 3. Abutting Joints

Abutting joints in compression members and girders flanges, and in tension members where so specified on the drawings, shall be faced and brought to an even bearing. Where joints are not faced, the opening shall not exceed 6.3 mm.

### 4. End Connection Angles

Floor beams, stringers and girders having end connection angles shall be built to plan length back to back of connection angles with a permissible tolerance of 0 mm to minus 1.6 mm. If end connections are faced, the finished thickness of the angles shall not be less than that shown on the detail drawings, but in no case less than 9.5 mm.

### 5. Lacing Bars

The ends of lacing bars shall be neatly rounded unless another form is required.

### 6. Fabrication of Members

Unless otherwise shown on the Plans, steel plates for main members and splice plates for flanges and main tension members, not secondary members, shall be cut and fabricated so that the primary direction of rolling is parallel to the direction of the main tensile and/or compressive stresses.

Fabricated members shall be true to line and free from twists, bends and open joints.

### 7. Web Plates (Riveted or Bolted)

In girders having no cover plates and not to be encased in concrete, the top edges of the web shall not extend above the backs of the flange angles and shall not be more than 3.2 mm below at any point. Any portion of the plate projection beyond the angles shall be chipped flush with the backs of the angles. Web plates of girders having cover plates may not be more than 12.7 mm less in width than the distance back to back of flange angles.

Splices in webs of girders without cover plates shall be sealed on top with red lead paste prior to painting.

At web splices, the clearance between the ends of the plates shall not exceed 9.5 mm. The clearance at the top and bottom ends of the web splice plates shall not exceed 6.3 mm.

## 8. Bent Plates

Cold-bent load-carrying rolled-steel plates shall conform to the following:

- a. They shall be so taken from the stock plates that the bendline will be at right angles to the direction of rolling, except that cold-bent ribs for orthotropic deck bridges may be bent in the direction of rolling if permitted by the Engineer.
- b. The radius of bends shall be such that no cracking of the plate occurs. Minimum bend radii, measured to the concave face of the metal, are shown in the following table:

ASTM DESIG- ATION	THICKNESS, t in mm					
	Up to 6.3	Over 6.3 To 12.7	Over 12.7 To 25.4	Over 25.4 to 38.1	Over 38.1 to 50.08	
A36	1.5t	1.5t	2t	3t	4t	
A242	2t	3t	5t	a---	a---	
A440	2.5t	3.5t	6t	a---	a---	
A441	2t	3t	5t	a---	a---	
A529	2t	2t	----	----	----	
A572	Gr.42	2t	2t	3t	4t	5t
	Gr.45	2t	2t	3t	4t	----
	Gr.50	2.5t	2.5t	4t	a---	----
	Gr.55	3t	3t	5t	a---	----
	Gr.60	3.5t	3.5t	6t	----	----
	Gr.65	4t	4t	----	----	----
A588	2t	3t	5t	a---	a---	
A514 <sup>b</sup>	2t	2t	2t	3t	3t	

<sup>a</sup> It is recommended that steel in this thickness range be bent hot. Hot bending however, may result in a slight decrease in the as-rolled mechanical properties.

- b The mechanical properties of ASTM A 514 steel results from a quench-and-temper-operation. Hot bending may adversely affect these mechanical properties. If necessary to hotbend, fabricator should discuss procedure with steel supplier.
- c Before bending, the corners of the plate be rounded to a radius of 1.6 mm throughout that portion of the plate where the bending is to occur.

## 9. Fit of Stiffeners

End stiffeners of girders and stiffeners intended as supports for concentrated loads shall have full bearing (either milled, ground or on weldable steel in compression areas of flanges, welded as shown on the Plans or specified) on the flanges to which they transmit load or from which they receive load. Stiffeners not intended to support concentrated loads shall, unless shown or specified otherwise, fit sufficiently tight to exclude water after being painted, except that for welded flexural members, the ends of stiffeners adjacent to the tension flanges shall be cut back as shown on the Plans. Fillers under stiffeners shall fit within 6.3 mm at each end.

Welding will be permitted in lieu of milling or grinding if noted on the Plans or in the Special Provisions. Brackets, clips, gussets, stiffeners, and other detail material shall not be welded to members or parts subjected to tensile stress unless approved by the Engineer.

## 10. Eyebars

Pin holes may be flame cut at least 50.8 mm smaller in diameter than the finished pin diameter. All eyebars that are to be placed side by side in the structure shall be securely fastened together in the order that they will be placed on the pin and bored at both ends while so clamped. Eyebars shall be packed and matchmarked for shipment and erection. All identifying marks shall be stamped with steel stencils on the edge of one head of each member after fabrication is completed so as to be visible when the bars are nested in place on the structure. The eyebars shall be straight and free from twists and the pin holes shall be accurately located on the centerline of the bar. The inclination of any bar to the plane of the truss shall not exceed 1.6 mm to 305 mm.

The edges of eyebars that lie between the transverse centerline of their pin holes shall be cut simultaneously with two mechanically operated torches abreast of each other, guided by a substantial template, in such a manner as to prevent distortion of the plates.

## 11. Annealing and Stress Relieving

Structural members which are indicated in the Contract to be annealed or normalized shall have finished machining, boring and straightening done subsequent to heat treatment. Normalizing and annealing (full annealing) shall be in accordance with ASTM E 44. The temperatures shall be maintained uniformly throughout the furnace during heating and cooling so that the temperature at no two points on the member will differ by more than 37.8<sup>0</sup>C at any one time.

Members of A514/A517 steels shall not be annealed or normalized and shall be stress relieved only with the approval of the Engineer.

A record of each furnace charge shall identify the pieces in the charge and show the temperatures and schedule actually used. Proper instruments including recording pyrometers, shall be provided for determining at any time the temperatures of members in the furnace. The records of the treatment operation shall be available to and meet the approval of the Engineer.

Members, such as bridge shoes, pedestals, or others which are built up by welding sections of plate together shall be stress relieved in accordance with the provisions of Subsection 403.3.11 when required by the Plans, Specifications or Special Provisions governing the Contract.

## 12. Tests

When full size tests of fabricated structural members or eyebars are required by the Contract, the Plans or Specifications will state the number and nature of the tests, the results to be attained and the measurements of strength, deformation or other performances that are to be made. The Contractor will provide suitable facilities, material, supervision and labor necessary for making and recording the tests. The members tested in accordance with the Contract will be paid for in accordance with Subsection 403.3.5.1. The cost of testing, including equipment handling, supervision labor and incidentals for making the test shall be included in the contract price for the fabrication or fabrication and erection of structural steel, whichever is the applicable item in the Contract, unless otherwise specified.

### **403.3.5 Pins and Rollers**

Pins and rollers shall be accurately turned to the dimensions shown on the Plans and shall be straight, smooth, and free from flaws. Pins and rollers more 228.6 mm or less in diameter may either be forged and annealed. Pins and rollers 228.6 mm or less in diameter may either be forged and annealed or cold-finished carbon-steel shafting.



In pins larger than 228.6 mm in diameter, a hole not less than 50.8 mm in diameter shall be bored full length along the axis after the forging has been allowed to cool to a temperature below the critical range under suitable conditions to prevent injury by too rapid cooling and before being annealed.

Pin holes shall be bored true to the specified diameter, smooth and straight, at right angles with the axis of the member and parallel with each other unless otherwise specified. The final surface shall be produced by a finishing cut.

The distance outside to outside of holes in tension members and inside to inside of holes in compression members shall not vary from that specified more than 0.8 mm. Boring of holes in built-up members shall be done after the riveting is completed.

The diameter of the pin hole shall not exceed that of the pin by more than 0.51 mm for pins 127 mm or less in diameter, or 0.8 mm for larger pins.

The pilot and two driving nuts for each size of pin shall be furnished, unless otherwise specified.

#### **403.3.6 Fastener Holes (Rivets and Bolts)**

All holes for rivets or bolts shall be either punched or drilled. Material forming parts or a member composed of not more than five thickness of metal may be punched 1.6 mm larger than the nominal diameter of the rivets or bolts whenever the thickness of the material is not greater than 19 mm for structural steel, 15.9 mm for high-strength steel or 12.7 mm for quenched and tempered alloy steel, unless subpunching and reaming is required for field connections.

When there are more than five thicknesses or when any of the main material is thicker than 19 mm for structural steel, 15.9 mm for high-strength steel, or 12.7 mm for quenched and tempered alloy steel, all holes shall either be subdrilled or drilled full size.

When required for field connections, all holes shall either be subpunched or subdrilled (subdrilled if thickness limitation governs) 4.8 mm smaller and, after assembling, reamed 1.6 mm larger or drilled full size 1.6 mm larger than the nominal diameter of the rivets or bolts.

When permitted by design criteria, enlarged or slotted holes are allowed with high-strength bolts. For punched holes, the diameter of the die shall not exceed the diameter of the punch by more than 1.6 mm. If any holes must be enlarged to admit the fasteners, they shall

be reamed. Holes shall be clean cut, without torn or ragged edges. Poor matching of holes will be cause for rejection.

Reamed holes shall be cylindrical, perpendicular to the member, and not more than 1.6 mm larger than the nominal diameter of the fasteners. Where practicable, reamers shall be directed by mechanical means. Drilled holes shall be 1.6 mm larger than the nominal diameter of the fasteners. Burrs on the outside surfaces shall be removed. Poor matching of holes will be cause for rejection. Reaming and drilling shall be done with twist drills. If required by the Engineer, assembled parts shall be taken apart for removal of burrs caused by drilling. Connecting parts requiring reamed or drilled holes shall be assembled and securely held while being reamed or drilled and shall be matchmarked before disassembling.

Unless otherwise specified, holes for all field connections and field splices of main truss or arch members, continuous beams, towers (each face), bents, plate girders and rigid frames shall be subpunched (or subdrilled if subdrilling is required) and subsequently reamed while assembled in the shop in accordance with Subsection 403.3.7.

All holes for floor-beam and stringer field end connections shall be subpunched and reamed to a steel template reamed while being assembled.

Reaming or drilling full size of field connection through templates shall be done after templates have been located with the utmost care as to position and angle and firmly bolted in place. Templates used for the reaming of matching members, or of the opposite faces of one member, shall be exact duplicated. Templates for connections which duplicate shall be so accurately located that like members are duplicates and require no matchmarking.

If additional subpunching and reaming is required, it will be specified in the Special Provisions or on the Plans.

Alternately, for any field connection or splice designated above in lieu of sub-sized holes and reaming while assembled, or drilling holes full-size while assembled, the Contractor shall have the option to drill bolt holes full-size in unassembled pieces and/or connections including templates for use with matching sub-sized and reamed holes means of suitable numerically-controlled (N/C) drilling equipment subject to the specific provisions contained in this Subsection.

If N/C drilling equipment is used, the Engineer, unless otherwise stated in the Special Provisions or on the Plans, may require the Contractor, by means if check assemblies to demonstrate that this drilling procedure consistently produces holes and connections meeting the requirements of conventional procedures.

The Contractor shall submit to the Engineer for approval a detailed outline of the procedures that he proposes to follow in accomplishing the work from initial drilling through

check assembly, if required, to include the specific members of the structure that may be N/C drilled, the sizes of the holes, the location of common index and other reference points, composition of check assemblies and all other pertinent information.

Holes drilled by N/C drilling equipment shall be drilled to appropriate size either through individual pieces, or any combination of pieces held tightly together.

All holes punched full size, subpunched or subdrilled shall be so accurately punched that after assembling (before any reaming is done), a cylindrical pin 3.2 mm smaller in diameter than the nominal size of the punched hole may be entered perpendicular to the face of the member, without drifting, in at least 75 percent of the contiguous holes in the same plane. If the requirement is not fulfilled, the badly punched pieces will be rejected. If any hole will not pass a pin 4.8 mm smaller in diameter than the nominal size of the punched holes, this will cause for rejection.

When holes are reamed or drilled, 85 percent of the holes in any continuous group shall, after reaming or drilling, show no offset greater than 0.8 mm between adjacent thickness of metal.

All steel templates shall have hardened steel bushings in holes accurately dimensioned from the center lines if the connections as inscribed on the template. The center lines shall be used in locating accurately the template from the milled or scribed ends of the members.

#### **403.3.7 Shop Assembly**

##### **1. Fitting for Riveting and Bolting**

Surfaces of metal in contact shall be cleaned before assembling. The parts of a member shall be assembled, well pinned and firmly drawn together with bolts before reaming or riveting is commenced. Assembled pieces shall be taken apart, if necessary, for the removal of burrs and shavings produced by the reaming operation. The member shall be free from twists, bends and other deformation. Preparatory to the shop riveting of full-sized punched material, the rivet holes, if necessary, shall be spear-reamed for the admission of the rivets. The reamed holes shall not be more than 1.6 mm larger than the nominal diameter of the rivets.

End connection angles, and similar parts shall be carefully adjusted to correct positions and bolted, clamped, or otherwise firmly in place until riveted.

Parts not completely riveted in the shop shall be secured by bolts, in so far as practicable, to prevent damage in shipment and handling.

## 2. Shop Assembling

The field connections of main members of trusses, arches, continuous beam spans, bents, towers (each face), plate girders and rigid frames shall be assembled in the shop with milled ends of compression members in full bearing, and then shall have their sub-size holes reamed to specified size while the connections are assembled. Assembly shall be “Full Truss or Girders Assembly” unless “Progressive Chord Assembly” or “Special Complete Structure Assembly” is specified in the Special Provisions or on the Plans.

Check assemblies with Numerically-Controlled Drilled Fields Connections shall be in accordance with the provision of 2 (f) of this Subsection.

Each assembly, including camber, alignment, accuracy of holes and fit of milled joints, shall be approved by the Engineer before reaming is commenced or before an N/C drilled check assembly is dismantled.

The fabricator shall furnish the Engineer a camber diagram showing the camber at each panel point in the cases of trusses or arch ribs and at the location of field splices and fractions of span length (0.25 points minimum, 0.10 points maximum) in case of continuous beam and girders or rigid frames. When the shop assembly is Full Truss or Girder Assembly or Special Complete Structure Assembly, the camber diagram shall show the camber measured in assembly. When any of the other methods of shop assembly is used, the camber diagram shall show calculated camber.

Methods of assembly shall be described below:

- a. Full of Truss or Girders Assembly shall consist of assembling all members of each truss, arch rib, bent, tower face, continuous beam line, plate girder or rigid frame at one time.
- b. Progressive Truss or Girder Assembly shall consist of assembling initially for each truss, arch rib, bent, tower face, continuous beam line, plate girder, or rigid frame all members in at least three continuous shop sections or panels but not less than the number of panels associated with three continuous chord lengths (i.e., length between field splices) and not less than 45.72 m in case of structures longer than 45.72 m. At least one shop section or panel or as many panels as are associated with a chord length shall be added at the advancing end of the assembly before any member is removed from the rearward end so that the assembled portion of the structure is never less than that specified above.

- c. Full Chord Assembly shall consist of assembling with geometric angles at the joints, the full length of each chord or each truss or open spandrel arch, or each leg of each bent or tower, than reaming their field connection holes while the members are assembled; and reaming the web member connections to steel templates set at geometric (not cambered) angular relation to the chord lines. Field connection holes in web members shall be reamed to steel templates. At least one end of each web member shall be milled or shall be scribed normal to the longitudinal axis of the member and the templates of both ends of the member shall be accurately located from one of the milled ends or scribed line.
- d. Progressive Chord Assembly shall consist of assembling contiguous chord members in the manner specified for Full Chord Assembly, and in the number and length specified for Progressive Truss or Girder Assembly.
- e. Special Complete Structure Assembly shall consist of assembling the entire structure, including the floor system. (This procedure is ordinarily needed only for complicated structures such as those having curved girders, or extreme skew in combination with severe grade or camber). The assembly including camber, alignment, accuracy of holes and fit of milled joints shall be approved by the Engineer before reaming is commenced.

A Contractor shall furnish the Engineer a camber diagram showing the camber at each panel point of each truss, arch rib, continuous beam line, plate girder or rigid frame. When shop assembly is Full Truss or Girder Assembly or Special Complete Structure Assembly, the camber diagram shall show the camber measured in assembly. When any of the other methods of shop assembly is used, the camber diagram shall show calculated camber.

- f. Check Assemblies with Numerically-Controlled Drilled Field Connections. A check assembly shall be required for each major structural type of each project, unless otherwise designated on the Plans or in the Special Provisions, and shall consist of at least three contiguous shop sections or, in a truss, all members in at least three contiguous panels but not less than the number of panels associated with three contiguous chord lengths (i.e., length between field splices). Check assemblies should be based on the proposed order erection, joints in bearings, special complex points, and similar considerations. Such special points could be the portals of skewed trusses, etc.

Use of either geometric angles (giving theoretically zero secondary stresses under deadload conditions after erection) or cambered angles (giving theoretically

zero secondary stresses under no-load conditions) should be designated on the Plans or in the Special Provisions.

The check assemblies shall be preferably be the first such sections of each major structural type to be fabricated.

No matchmaking and no shop assemblies other than the check assemblies shall be required.

If the check assembly fails in some specific manner to demonstrate that the required accuracy is being obtained, further check assemblies may be required by the Engineer for which there shall be no additional cost to the contracting authority.

#### **403.3.8 Rivets and Riveting**

The size of rivets called for on the Plans shall be the size before heating. Rivet heads shall be of standard shape, unless otherwise specified, and of uniform size for the same diameter of rivet. They shall be full, neatly made, concentric with the rivets holes, and in full contact with the surface of the member. Sufficient rivets for field connections shall be furnished to rivet the entire structure with an ample surplus to replace all rivets burned, lost or cut out.

Rivets shall be heated uniformly to a “light cherry red color” and shall be driven while hot. Any rivet whose point is heated more than the remainder shall not be driven. When a rivet is ready for driving, it shall be free from slag, scale and other adhering matter. Any rivet which is sealed excessively, will be rejected.

All rivets that are loose, burned, badly formed, or otherwise defective shall be removed and replaced with satisfactory rivets. Any rivet whose head is defective in size or whose head is driven off center will be considered defective and shall be removed. Stitch rivets that are loosened by driving of adjacent rivets shall be removed and replaced with satisfactory rivets. Caulking, recapping, or double gunning of rivets heads will not be permitted.

Shop rivets shall be driven by direct-acting rivet machines when practicable. Approved bevelled rivet sets shall be used for forming rivet heads on sloping surfaces. When the use of a direct-acting rivet machine is not practicable, pneumatic hammers of approved size shall be used. Pneumatic bucking tools will be required when the size and length of the rivets warrant their use.

Rivets may be driven cold provided their diameter is not over 9.5 mm.

## **403.3.9 Bolted Connections, Unfurnished, Turned and Ribbed Bolts**

### **1. General**

Bolts under this Subsection shall conform to “Specifications for Carbon Steel Externally and Internally Threaded Standard Fasteners”, ASTM A 307. Specifications for high strength bolts are covered under Subsection 403.3.10.

Bolts shall be unfinished, turned or an approved form of ribbed bolts with hexagonal nuts and heads except that ribbed bolts shall have button heads. Bolted connections shall be used only as indicated by the Plans or Special Provisions. Bolts not tightened to the proof loads shall have single self locking nuts or double nuts. Bevel washers shall be used where bearing faces have a slope or more than 1:20 with respect to a plane normal to the bolt axis. Bolts shall be of such length that will extend entirely through their nuts but not more than 6.3 mm beyond them.

Bolts shall be driven accurately into the holes without damage to the threads. A snap shall be used to prevent damage to the heads. The heads and nuts shall be drawn tight against the work with the full effort of a man using a suitable wrench, not less than 381 mm long for bolts of nominal diameter 19 mm and over. Heads of bolts shall be tapped with a hammer while the nuts are being tightened.

### **2. Unfinished Bolts**

Unfinished bolts shall be furnished unless other types are specified. The number of bolts furnished shall be 5 percent more than the actual number shown on the Plans for each size and length.

### **3. Turned Bolts**

The surface of the body of turned bolts shall meet the ANSI roughness rating value of 125. Heads and nuts shall be hexagonal with standard dimensions for bolts of the nominal size specified or the next larger nominal size. Diameter of threads shall be equal to the body of the bolt or the nominal diameter of the bolt specified. Holes for turned bolts shall be carefully reamed with bolts furnished to provide for a light driving fit. Threads shall be entirely outside of the holes. A washer shall be provided under the nut.

### **4. Ribbed Bolts**

The body of ribbed shall be of an approved form with continuous longitudinal ribs. The diameter of the body measured on a circle through the points of the ribs shall be 1.98 mm greater than the nominal diameter specified for the bolts.

Ribbed bolts shall be furnished with round heads conforming to ANSI B 18.5 unless otherwise specified. Nuts shall be hexagonal, either recessed or with a washer of suitable thickness. Ribbed bolts shall make a driving fit with the holes. The hardness of the ribs shall be such that the ribs do not mash down enough to permit the bolts to turn in the holes during tightening. If for any reason the bolt twists before drawing tight, the holes shall be carefully reamed and an oversized bolt used as a replacement. The Contractor shall provide and supply himself with oversize bolts and nuts for this replacement in an amount not less than ten percent (10%) of the number of ribbed bolts specified.

**403.3.10 Bolted Connections (High Tensile-Strength Bolts)**

1. Bolts

Bolts shall be AASHTO M 164 (ASTM A 325 or AASHTO M 253) tensioned to a high tension. Other fasteners which meet the chemical requirements of AASHTO M 164 or M 253 and which meet the mechanical requirements of the same specification in full size tests and which have body diameter and bearing areas under the head and nut, or their equivalents, not less than those provided by a bolt and nut of the same nominal dimensions prescribed above, may be used subject to the approval of the Engineer.

Bolts lengths shall be determined by adding the grip-length values given in Table 403.1 to the total thickness of connected material. The values of Table 403.1 compensate for manufacturer’s tolerance, the use of heavy semi-finished hexagon nut and a positive “stick-through” at the end of the bolt. For each hardened flat washer that is used and 4 mm to the tabular value and for each bevelled washer add 7.9 mm. The length determined shall be adjusted to the next longer 6.3 mm.

**Table 403.1 – Grip-Length Values**

Bolts Size (mm)	To determine required bolt length, add grip (mm) *
9.5	17.5



12.7	22.2
19.0	25.4
22.2	28.6
25.4	31.7
28.6	38.1
31.7	41.3
34.9	44.4
38.1	47.6

\* Does not include allowance for washer thickness

## 2. Bolted Parts

The slope of surface of bolted parts in contact with the bolt head and nut shall not exceed 1:20 with respect to a plane normal to the bolt axis. Bolted parts shall fit solidly together when assembled and shall not be separated by gaskets or any other interposed compressible material. When assembled, all joint surfaces, including those adjacent to the bolt head, nuts or washers, shall be free of scale, except tight mill scale, and shall also be free of burrs, dirt and other foreign material that would prevent solid seating of the parts. Paint is permitted unconditionally in bearing-type connections.

In friction-type connections, the Class, as defined below, indicating the condition of the contact surfaces shall be specified on the Plans. Where no Class is specified, all joint surfaces shall be free of scale, except tight mill scale and shall not have a vinyl wash.

- a. Classes A, B and C (uncoated). Contact surfaces shall be free of oil, paint, lacquer or other coatings.
- b. Class D (hot-dip galvanized and roughened). Contact surfaces shall be tightly scored by wire brushing or blasting after galvanizing and prior to assembly. The wire brushing treatment shall be a light application of manual or power brushing that marks or scores the surface but remove relatively little of the zinc coating. The blasting treatment shall be a light "brush-off" treatment which will produce a dull gray appearance. However, neither treatment should be severe enough to produce any break or discontinuity in the zinc surface.

- c. Classes E and F (blast-cleaned, zinc rich paint). Contact surfaces shall be coated with organic or inorganic zinc rich paint as defined in the Steel Structures Painting Council Specification SSPC 12.00.
- d. Classes G and H (blast-cleaned, metallized zinc or aluminum). Contact surfaces shall be coated in accordance with AWS C2.2, Recommended Practice for Metallizing with Aluminum and Zinc for Protection of Iron and Steel, except that subsequent sealing treatments, described in Section IV therein shall not be used.
- e. Class I (vinyl wash). Contact surfaces shall be coated in accordance with the provisions of the Steel Structure Painting Council Pretreatment Specifications SSPC PT3.

AASHTO M 164 (ASTM A 325) Type 2 and AASHTO M 253 bolts shall not be galvanized nor shall they be used to connect galvanized material.

### 3. Installation

- a. Bolt Tension. Each fastener shall be tightened to provide, when all fasteners in the joints are tight at least the minimum bolt tension shown in Table 403.2 for the size of fastener used.

Threaded bolts shall be tightened with properly calibrated wrenches or by the turn-of-nut method. If required, because of bolt entering and wrench operation clearances, tightening by either procedure may be done by turning the bolt while the nut is prevented from rotating. Impact wrenches, if used, shall be of adequate capacity and sufficiently supplied with air to perform the required tightening of each bolt in approximately ten seconds.

AASHTO M 253 and galvanized AASHTO M 164 (ASTM A 325) bolts shall not be reused. Other AASHTO M 164 (ASTM A 325) bolts may be reused, but not more than once, if approved by the Engineer. Retightening previously tightened bolts which may have been loosened by the tightening of adjacent bolts shall not be considered as a reuse.

- b. Washers. All fasteners shall have a hardened washer under the element (nut or bolt head) turned in tightening except that AASHTO M 164 (ASTM A 325) bolts installed by the turn of the nut method in holes which are not oversized or slotted may have the washer omitted. Hardened washers shall be used under both the head and nut regardless of the element turned in the

case of AASHTO M 253 bolts if the material against which it bears has a specified yield strength less than 275.76 MPa.

**Table 403.2 – Bolt Tension**

<b>Bolt Size, mm</b>	<b>Minimum Bolt Tension<sup>1</sup>, kg.</b>	
	<b>AASHTO M 164 (ASTM A 325) Bolts</b>	<b>AASHTO M 253 (ASTM A 420) Bolts</b>
12.7	5 466	6 758
15.9	8 709	10 569
19.0	12 882	15 821
22.2	13 268	21 999
25.4	23 360	24 312
28.6	25 605	36 786
31.7	32 522	45 858
34.9	38 760	55 111
38.1	47 174	66 905

**<sup>1</sup> Equals to 70 percent of specified minimum tensile strength bolts. Where an outer face of the bolted parts has a slope of more than 1:20 with respect to a Plane normal to the bolt axis, a smooth bevelled washer shall be used to compensate for the lack of parallel line.**

- c. **Calibrated Wrench Tightening.** When Calibrated wrenches are used to provide the bolt tension as specified above, their setting shall be such as to induce a bolt tension 5 to 10 percent in excess of this value. These wrenches shall be calibrated at least once each working day by tightening, in a device capable of indicating actual bolt tension, not less than three typical bolts of each diameter from the bolts to be installed. Power wrenches shall be adjusted to installed or cut-out at the selected tension. If manual torque wrenches are used, the torque indication corresponding to the calibrating tension shall be noted and used in the installation of all the tested lot. Nuts shall be turned in the tightening direction when torque is measured. When using calibrated wrenches to install several bolts in a single joint, the wrench shall be returned to “touch-up” bolts previously tightened which may have

been loosened by the tightening of adjacent bolts, until all are tightened to the prescribed amount.

- d. Turn-of-Nut Tightening. When the turn-of-nut method is used to provide the bolt tension specified in (a) above, there shall first be enough bolts brought to a “snug tight” condition to insure that the parts of the joint are brought into full contact with each other. Snug tight is defined as the tightness attained by a few impacts of an impact wrench or the full effort of a man using an ordinary spud wrench. Following this initial operation, bolts shall be placed in any remaining holes in the connection and brought to snug tightness.

All bolts in the joints shall then be tightened additionally, by the applicable amount of nut rotation specified in Table 403.3 with tightening progressing systematically from the most rigid part of the joint to its free edges. During this operation, there shall be no rotation of the part not turned by the wrench.

- e. Lock Pin and Collar Fasteners. The installation of lock pin and collar fasteners shall be by methods approved by the Engineer.

Table 403.3 – Nut Rotation From Snug Tight Condition<sup>±</sup>

Bolt Length measured from underside of head to extreme end of point	Disposition of Outer Faces of Bolted Parts		
	Both faces normal to bolt axis	One face normal to bolt axis and other face sloped not more than 1:20 (bevel washer not used)	Both faces sloped not more than 1:20 from normal to bolt axis (bevel washers not used)
Up to and including 4 diameters	0.33 turn	0.5 turn	0.66 turn
Over 4 diameters but not exceeding 8 diameters	0.5 turn	0.66 turn	0.625 turn
Over 8 diameters but not			

exceeding diameters <sup>2</sup>	12	0.66 turn	0.83 turn	1 turn
----------------------------------	----	-----------	-----------	--------

- <sup>1</sup> **Nut rotation is relative to bolt, regardless of the element (nut or bolt) being turned. For bolts installed by 1/2 turn and less the tolerance should be plus or minus 30<sup>0</sup>, for bolts installed by 2/3 turn and more, the tolerance should be plus or minus 45<sup>0</sup>.**
- <sup>2</sup> **No research work has been performed by the Research Council on Riveted and Bolted Structural joints to establish the turn-of-nut procedure when bolt lengths exceed 12 diameters. Therefore, the required rotation must be determined by actual tests in a suitable tension device simulating the actual conditions.**

#### 4. Inspection

The Engineer will determine that the requirements of these Specifications are not in the work. When the calibrated wrench method of tightening is used, the Engineer shall have full opportunity to witness the calibration tests.

The Engineer will observe the installation and tightening of the bolts to determine that the selected tightening procedure is properly used and will determine that all bolts are tightened.

The following inspection shall be used unless a more extensive or different procedure is specified:

- a. The Contractor shall use an inspecting wrench which may either be a torque wrench or a power wrench that can be accurately adjusted in accordance with the requirements of Subsection 403.3.10(3) (c) above, in the presence of the Engineer.
- b. Three bolts of the same grade, size and condition as those under inspection shall be placed individually in a calibration device capable of indicating bolt tension. Length may be any length representative of bolts used in the structure. There shall be a washer under the part turned in tightening each bolt.
- c. When the inspecting wrench is a torque wrench, each of the three bolts specified above shall be tightened in the calibration device by any

convenient means to the minimum tension specified for its size in Table 403.2. The inspecting wrench shall then be applied to the tightened bolt and the torque necessary to run the nut or head 5 degrees (approximately 25.4 mm at 304.8 mm radius) in the tightening direction shall be determined. The average torque measured in the tests of three bolts shall be taken as the job inspection torque to be used in the manner specified below.

- d. When the inspecting wrench is a power wrench, it shall be adjusted so that it will tighten each of the three bolts specified to a tension at least 5 but not more than 10 percent greater than the minimum tension specified for its size in Table 403.2. This setting of wrench shall be taken as the job inspecting torque to be used in the manner specified below.
- e. Bolts, represented by the three samples bolts prescribed above, which have been tightening in the structure shall be inspected by applying, in the tightening direction, the inspecting wrench and its job inspecting torque to 10 percent of the bolts, but not less than two bolts selected at random in each connection. If no nut or bolt head is turned by this application of the job inspecting torque, the connection shall be accepted as properly tightened. If any nut or bolt head is turned by the application of the job inspecting torque, this torque shall be applied to all bolts in the connection, and all bolts whose nut or head is turned by the job inspecting torque shall be tightened and re-inspected, or alternatively, the fabricator or erector, at his option may re-tighten all the bolts in the connection and then resubmit the connection for the specified inspection.

#### **403.3.11 Welding**

Welding shall be done in accordance with the best modern practice and the applicable requirements at AWS D1.1 except as modified by AASHTO “Standard Specifications for Welding of Structural Steel Highway Bridges”.

#### **403.3.12 Erection**

##### **1. General**

The Contractor shall provide the falsework and all tools, machinery and appliances, including driftpins and fitting-up bolts, necessary for the expeditious handling of the work and shall erect the metal work, remove the temporary construction, and do all work necessary to complete the structure as required by the Contract and in accordance with the Plans and these Specifications.

If shown on the Plans or in the Special Provisions, the Contractor shall dismantle the old structure on the bridge site in accordance with Item 101, Removal of Structures and Obstructions.

#### **403.3.13 Handling and Storing Materials**

Materials to be stored shall be placed on skids above the ground. It shall be kept clean and properly drained. Girders and beams shall be placed upright and shored. Long members, such as columns and chords, shall be supported on skids placed near enough together to prevent injury from deflection. If the Contract is for erection only, the Contractor shall check the material turned over to him against the shipping lists and report promptly in writing any shortage or damage discovered. He shall be responsible for the loss of any material while in his care, or for any damage caused to it after being received by him.

#### **403.3.14 Falsework**

The false work shall be properly designed and substantially constructed and maintained for the loads which will come upon it. The Contractor shall prepare and submit to the Engineer working drawings for falsework and working drawings for changes in any existing structure for maintaining traffic, in accordance with Clause 45 of Part G, Div. II, Vol. I.

#### **403.3.15 Method and Equipment**

Before starting the work of erection, the Contractor shall inform the Engineer fully as to the method of erection he proposes to follow, and the amount and character of equipment he proposes to use, which shall be subject to the approval of the Engineer. The approval of the Engineer shall not be considered as relieving the Contractor of the responsibility for the safety of his method or equipment or from carrying out the work in full accordance with the Plans and Specifications. No work shall be done until such approval by the Engineer has been obtained.

#### **403.3.16 Straightening Bent Materials**

The strengthening of plates, angles, other shapes and built-up members, when permitted by the Engineer, shall be done by methods that will not produce fracture or other injury. Distorted members shall be straightened by mechanical means or, if approved by the Engineer, by the carefully planned and supervised application of a limited amount of localized heat, except that heat straightening of AASHTO M 244 (ASTM A 514) or ASTM A 517 steel members shall be done only under rigidly controlled procedures, each application subject to the approval of the Engineer. In no case shall the maximum temperature of the AASHTO M 244 (ASTM A 514) or ASTM A 517 steels exceed 607.2<sup>0</sup>C, nor shall the temperature exceed

510<sup>0</sup>C at the weld metal or within 152.4 mm of weld metal. Heat shall not be applied directly on weld metal. In all other steels, the temperature of the heated area shall not exceed 648.9<sup>0</sup>C (a dull red) as controlled by temperature indicating crayons, liquids or bimetal thermometers.

**Parts to be heat-straightened shall be substantially free of stress and from external forces, except stresses resulting from mechanical means used in conjunction with the application of heat.**

**Following the straightening of a bend or buckle, the surface of the metal shall be carefully inspected for evidence of fracture.**

#### **403.3.17 Assembling Steel**

The parts shall be accurately assembled as shown on the working drawings and any matchmarks shall be followed. The material shall be carefully handled so that no parts will be bent, broken or otherwise damaged. Hammering which will injure or distort the members shall not be done. Bearing surfaces and surfaces to be in permanent contact shall be cleaned before the members are assembled. Unless erected by the cantilever methods, truss spans shall be erected on blocking so placed as to give the trusses proper camber. The blocking shall be left in place until the tension chord splices are fully connected with permanent fasteners and all other truss connections pinned and erection bolted. Splices of butt joints of compression members, that are milled to bear and of railing shall not be permanently fastened until the spans have been swung, except that such permanent fastening may be accomplished for the truss members at any time that joint holes are fair. Splices and field connections shall

have one-half of the holes filled with erection bolts and cylindrical erection pins (half bolts and half pins) before placing permanent fasteners. Splices and connections carrying traffic during erection shall have three-fourths of the holes so filled, unless otherwise permitted by the Engineer.

Fitting-up bolts shall be of the same nominal diameter as the permanent fasteners and cylindrical erection pins will be 1.6 mm larger.

#### **403.3.18 Riveting**

Pneumatic hammers shall be used for field riveting except when the use of hand tools is permitted by the Engineer. Rivets larger than 15.9 mm in diameter shall not be driven by hand. Cup-faced dollies, fitting the head closely to insure good bearing, shall be used. Connections shall be accurately and securely fitted up before the rivets are driven.

Drifting shall be only such as to draw the parts into position and not sufficient to enlarge the holes or distort the metal. Unfair holes shall be reamed or drilled. Rivets shall be heated uniformly to a "light cherry red" color and shall be driven while hot. They shall not be overheated or burned. Rivet heads shall be full and symmetrical, concentric with the shank, and shall have full bearing all around. They shall not be smaller than the heads of the shop



rivets. Rivets shall be tight and shall grip the connected parts securely together. Caulking or recupping will not be permitted. In removing rivets, the surrounding metal shall not be injured. If necessary, they shall be drilled out.

#### **403.3.19 Pin Connections**

Pilot and driving nuts shall be used in driving pins. They shall be furnished by the Contractor without charge. Pins shall be so driven that the members will take full bearing on them. Pin nuts shall be screwed up tight and the threads burred at the face of the nut with a pointed tool.

#### **403.3.20 Setting Shoes and Bearings**

Shoes and bearing shall not be placed on bridge seat bearing areas that are improperly finished, deformed, or irregular. They shall be set level in exact position and shall have full and even bearing. The shoes and bearing plates may be set by either of the following methods:

##### **1. Method 1**

The bridge seat bearing area shall be heavily coated with red lead paint and then covered with three layers of 405 to 472 g/m<sup>2</sup> duck, each layer being coated thoroughly on its top surface with red lead paint. The shoes and bearing plates shall be placed in position while the paint is plastic.

As alternatives to canvas and red lead, and when so noted on the Plans or upon written permission by the Engineer, the following may be used:

- a. Sheet lead of the designated thickness
- b. Preformed fabric pad composed of multiple layers of 270 g/m<sup>2</sup> duck impregnated and bound with high quality natural rubber or of equivalent and equally suitable materials compressed into resilient pads of uniform thickness. The number of plies shall be such as to produce the specified thickness, after compression and vulcanizing. The finished pads shall withstand compression loads perpendicular to the plane of the laminations of not less than 7 kg/mm<sup>2</sup> without detrimental reduction in thickness or extension.
- c. Elastomeric bearing pads

## 2. Method 2

The shoes and bearing plates shall be properly supported and fixed with grout. No load shall be placed on them until the grout has set for at least 96 hours, adequate provision being made to keep the grout well moistened during this period. The grout shall consist of one part Portland Cement to one part of fine-grained sand.

The location of the anchor bolts in relation to the slotted holes in expansion shoes shall correspond with the temperature at the time of erection. The nuts on anchor bolts at the expansion ends shall be adjusted to permit the free movement of the span.

### **403.3.21 Preparing Metal Surfaces for Painting**

All surfaces of new structural steel which are to be painted shall be blast cleaned unless otherwise specified in the Special Provisions or approved in writing by the Engineer.

In repainting existing structures where partial cleaning is required, the method of cleaning will be specified in the Special Provision.

The steel surfaces to be painted shall be prepared as outlined in the "Steel Structures Painting Council Specifications" (SSPC) meeting one of the following classes of surface preparation.

- a. SSPC – SP – 5 White Metal Blast Cleaning
- b. SSPC – SP – 6 Commercial Blast Cleaning
- c. SSPC – SP – 8 Pickling
- d. SSPC – SP – 10 Near White Blast Cleaning

Blast cleaning shall leave all surfaces with a dense and uniform anchor pattern of not less than one and one-half mills as measured with an approved surface profile comparator.

Blast cleaned surfaces shall be primed or treated the same day blast cleaning is done. If cleaned surface rust or are contaminated with foreign material before painting is accomplished, they shall be re-cleaned by the Contractor at his expense.

When paint systems No. 1 or 3 are specified, the steel surfaces shall be blast cleaned in accordance with SSPC – SP – 10. When paint systems No. 2, 4 or 5 are specified, the steel surface shall be blast cleaned in accordance with SSPC – SP – 6.

### **403.3.22 System of Paint**

The paint system to be applied shall consist of one as set forth in Table 403.4 and as modified in the Special Provisions.

### **403.3.23 Painting Metal Surfaces**

#### **1. Time of Application**

The prime coat of paint or pretreatment when specified, shall be applied as soon as possible after the surface has been cleaned and before deterioration of the surface occurs. Any oil, grease, soil, dust or foreign matter deposited on the surface after the surface preparation is completed shall be removed prior to painting. In the event the rusting occurs after completion of the surface preparation, the surfaces shall be again cleaned.

Particular care shall be taken to prevent the contamination of cleaned surfaces with salts, acids, alkali, or other corrosive chemicals before the prime coat is applied and between applications of the remaining coats of paint. Such contaminants shall be removed from the surface. Under these circumstances, the pretreatments or, in the absence of a pretreatment, the prime coat of paint shall be applied immediately after the surface has been cleaned.

#### **2. Storage of Paint and Thinner**

All paint and thinner should preferably be stored in a separate building or room that is well ventilated and free from excessive heat, sparks, flame or the direct ray of the sun.

All containers of paint should remain unopened until required for use. Containers which have been opened shall be used first.

Paint which has livered, gelled, or otherwise deteriorated during storage shall not be used. Thixotropic materials which may be stirred to attain normal consistency are satisfactory.

#### **3. Mixing and Thinning**

All ingredients in any container of paint shall be thoroughly mixed before use and shall be agitated often enough during application to keep the pigment in suspension.

Paint mixed in the original container shall not be transferred until all settled pigment is incorporated into the vehicle. This does not imply that part of the vehicle cannot be poured off temporarily to simplify the mixing.

Mixing shall be by mechanical methods, except that hard mixing will be permitted for container up to 19 litres in size.

Mixing in open containers shall be done in a well ventilated area away from sparks or flames.

Paint shall not be mixed or kept in suspension by means of an air stream bubbling under the paint surface.

When a skin has formed in the container, the skin shall be cut loose from the sides of the container, removed, and discarded. If such skins are thick enough to have a practical effect on the composition and quality of the paint, the paint shall not be used.

The paint shall be mixed in manner which will insure breaking up of all lumps, complete dispersion of settled pigment, and a uniform composition. If mixing is done by hand, most of the vehicle shall be poured off into a clean container. The pigment in the paint shall be lifted from the bottom of the container with a broad, flat paddle, lumps shall be broken up, and the pigment thoroughly mixed with the vehicle. The poured off vehicle shall be returned to the paint with simultaneous stirring, or pouring repeatedly from one container to another until the composition is uniform. The bottom of the container shall be inspected for unmixed pigment. Tinting pastes or colors shall be wetted with a small amount of thinner, vehicle, or paint and thoroughly mixed. The thinned mixture shall be added to the large container of paint and mixed until the color is uniform.

Paint which does not have a limited pot life, or does not deteriorate on standing, may be mixed at any time before using, but if settling has occurred, it must be remixed immediately before using. Paint shall not remain in spray pots, painter's buckets, etc., overnight, but shall be gathered into a container and remixed before use.

No thinner shall be added to the paint unless necessary for proper application. In no case shall more than 0.5 litres of thinner be added per 3.8 litres unless the paint is intentionally formulated for greater thinning.

The type of thinner shall comply with the paint specification.

When the use of thinner is permissible, thinner shall be added to paint during the mixing process. Painters shall not add thinner to paint after it has been thinned to the correct consistency.

All thinning shall be done under supervision of one acquainted with the correct amount and type of thinner to be added to the paint.

**Table 403.4 – Paint System**

	Paint System				
	1	2		4	5
High Pollution or Coastal	x	x	x		
Mild Climate				x	X

Note:

1. Paint system shown for severe areas are satisfactorily in less severe areas.
2. Coastal - within 304.8 m of ocean or tidal water.

High pollution-air pollution environment such as industrial areas.

Mild-other than coastal areas not in air pollution environment.

All structural steel shall be painted by one of the following systems. The required system or choice of systems will be shown in the Contract.

System 4 is intended for use in mild climates or to repaint existing structures where the other systems are not compatible.

Coating Thickness	Specifications	Min. Dry Film
System 1 – Vinyl Paint System		
Wash Prime	708.03 (b)	12.7

Intermediate Coat	708.03 (b)	38.10 – 50.80
3 <sup>rd</sup> Coat	708.03 (b)	38.10 – 50.80
4 <sup>th</sup> Coat	708.03 (b)	38.10 – 50.80
Finish Coat	708.03 (b)	38.10 – 50.80
Total thickness 165.10 – 203.20		
System 2 – Epoxy-Polyimide System		
Prime Coat	708.03 (c)	50.80 – 76.20
Intermediate Coat	708.03 (c)	50.80 – 76.20
3 <sup>rd</sup> Coat	708.03 (c)	50.80 – 76.20
Finish Coat	708.03 (c)	38.10 – 50.80
Total thickness 190.50 – 279.40		
* The third coat may be eliminated in mild climates		

Coating Thickness	Specifications	Min. Dry Film
System 3 – Inorganic Zinc-Rich Coating System		
Prime Coat	708.03(d)	88.90 – 127
Epoxy Intermediate Coat	708.03 (d)	40.80 – 76.20
Finish Coat	708.03 (d)	38.10 – 50.80
Total thickness 177.80 – 254		
Alternate System		
Prime Coat	708.03 (d)	88.90 – 127
Wash Primer Tie Coat	708.03 (d)	12.70
Finish Coat	708.03 (d)	38.10 – 50.80
Total thickness 139.70 – 190.50		
System 4 – Alkyd-Oil-Basic Lead-Chromate System		

Prime Coat	708.03 (e)	38.10 – 50.80
Intermediate Coat	708.03 (e)	38.10 – 50.80
Finish Coat	708.03 (e)	38.10 – 50.80
Total thickness		114.30 – 152.40
* The paint system may be specified as four coats for new structure steel in mild climate, with a minimum thickness of 152.40 mm.		
System 5 – Organic Zinc-Rich Paint System		
Prime Coat	708.03 (f)	38.10 – 50.80
Intermediate Coat	708.03 (f)	50.80 – 63.50
Wash Primer Tie Coat	708.03 (f)	12.70
Finish Coat	708.03 (f)	38.10 – 50.80
Total thickness		139.70 – 177.80

#### 4. Application of Paint

##### a. General

The oldest of each kind of paint shall be used first. Paint shall be applied by brushing or spraying or a combination of these methods. Daubers or sheepskins may be used when no other method is practicable for proper application in places of difficult access. Dipping, roller coating, or flow coating shall be used only when specifically authorized. All paints shall be applied in accordance with the manufacturer's instructions.

Open seams at contact surfaces of built up members which would retain moisture shall be caulked with red lead paste, or other approved material, before the second undercoat of paint is applied.

Paint shall not be applied when the surrounding air temperature is below 4.4°C. Paint shall not be applied when the temperature is expected to drop to 0°C before the paint has dried. Paint shall not be applied to steel at a temperature over 51.7°C unless the paint is specifically formulated for application at the proposed temperature, nor shall paint be applied to steel which is at a temperature that will cause blistering or porosity or otherwise will be detrimental to the life of the paint.

Paint shall not be applied in fog or mist, or when it is raining or when the relative humidity exceeds 85 percent. Paint shall not be applied to wet or damp surfaces.

When paint must be applied in damp or cold weather, the steel shall be painted under cover, or protected, or sheltered or the surrounding air and the steel heated to a satisfactory temperature. In such cases, the above temperature and humidity conditions shall be met. Such steel shall remain under cover or be protected until dry or until weather conditions permit its exposure.

Any applied paint exposed to excess humidity, rain or condensation shall first be permitted to dry. Then damaged areas of paint shall be removed, the surface again prepared and then repainted with the same number of coats of paint of the same kind as the undamaged areas.

If stripe painting is stipulated in the Special Provisions or if the Contractor chooses to do so at his option, all edges, corners, crevices, rivets, bolts, weld and sharp edges shall be painted with the priming paint by brush before the steel receives first full prime coat of paint. Such striping shall extend for at least 25.4 mm from the edge. When practicable, this stripe coat shall be permitted to dry before the prime coat is applied, otherwise the stripe coat shall set to touch before the full prime coat is applied. However, the stripe coat shall not be permitted to dry for a period of long enough to allow rusting of the unprimed steel. When desired, the stripe coat may be applied after a complete prime coat.

To the maximum extent practicable, each coat of paint shall be applied as continuous film of uniform thickness free of pores. Any thin spots or areas missed in the application shall be repainted and permitted to dry before the next coat of paint is applied. Film thickness is included in the description of paint systems. Each coat of paint shall be in a proper state of cure or dryness before application of the succeeding coat.

b. Brush Application

Paint shall be worked into all crevices and corners where possible and surfaces not accessible to brushes shall be painted by spray, doubers, or sheepskins. All runs or rags shall be brushed out. There shall be a minimum of brush marks left in the paint.

c. Spray Application of Paint



The equipment used for spray application of paint shall be suitable for the intended purpose, shall be capable of properly atomizing the paint to be applied and shall be equipped with suitable pressure regulators and gages. The air caps, nozzles, and needles shall be those recommended by the manufacturer of the equipment for the material being sprayed. The equipment shall be kept in satisfactory condition to permit proper paint application. In closed or recirculating paint spray system, where gas under pressure is used over the liquid, the gas shall be an inert, one such as nitrogen. Traps or separators shall be provided to remove oil and water from the compressed air. These traps or separators shall be adequate size and shall be drained periodically during operations. The air from the spray gun impinging against the surface shall show no water or oil.

Paint ingredients shall be kept properly mixed in the spray pots or containers during paint applications either by continuous mechanical agitation or by intermittent agitation as frequently as necessary.

The pressure on the material in the pot and of the air at the guns shall be adjusted for optimum spraying effectiveness. The pressure on the material in the pot shall be adjusted when necessary for changes in elevation of the gun above the pot. The atomizing air pressure at the gun shall be high enough to atomize the paint properly but not so high as to cause excessive fogging of paint, excessive evaporation of solvent or loss by overspray.

Spray equipment shall be kept sufficiently clean so that dirt, dried paint and other foreign material are not deposited in the paint film. Any solvents left in the equipment shall be completely removed before applying paint to the surface being painted.

Paint shall be applied in uniform layer, with overlapping at the edge of the spray pattern. The spray shall be adjusted so that the paint is deposited uniformly. During application, the gun shall be held perpendicular to the surface and at a distance which will insure that a wet layer of paint is deposited on the surface. The trigger of the gun should be released at the end of each stroke.

All runs and sags shall be brushed out immediately or the paint shall be removed and the surface repainted. Spray application of prime coats shall in all cases be immediately followed by brushing

Areas inaccessible to the spray gun shall be painted by brush, if not accessible by brush, daubers or sheepskins shall be used. Brushes shall be used to work paint into cracks, crevices and blind spots where are not adequately painted by spray.

d. Shop Painting

Shop painting shall be done after fabrication and before any damage to the surface occurs from weather or other exposure. Shop contact surfaces shall not be painted unless specified.

Surfaces not to be in contact but which will be inaccessible after assembly shall receive the full paint system specified or three shop coats of the specified before assembly.

The areas of steel surfaces to be in contact with concrete shall not be painted, unless otherwise shown on the Plans, the areas of steel surfaces to be in contact with wood shall receive either the full paint coats specified or three shop coats of the specified primer.

If paint would be harmful to a welding operator or would be detrimental to the welding operation or the finished welds, the steel shall not be painted within a suitable distance from the edges to be welded. Welding through inorganic zinc paint systems will not be permitted unless approved by the Engineer.

Antiweld spatter coatings shall be removed before painting. Weld slag and flux shall be removed by methods at least as effective as those specified for the cleaning.

Machine-finished or similar surfaces that are not to be painted, but do not require protections, shall be protected with a coating of rust inhibitive petroleum, other coating which may be more suitable, for special conditions.

Erection marks and weight marks shall be copied on area that have been previously painted with the shop coat.

e. Field Painting

Steel structures shall be painted as soon as practicable after erection.

Metal which has been shop coated shall be touched up with the same type of paints as the shop coat. This touch-up shall include cleaning and painting of field connections, welds, rivets and all damaged or defective paint and rusted areas. The Contractor may, at his option, apply an overall coat of primer in place of touch-up spot painting.

Surfaces (other than contact surfaces) which are accessible before erection but which will not be accessible after erection shall receive all field coats of paint before erection.

If possible the final coat of paint shall not be applied until all concrete work is finished. If concreting or other operations damage any paint, the surfaces shall be cleaned and repainted. All cement or concrete spatter and dripping shall be removed before any paint is applied.

Wet paint shall be protected against damage from dust or other detrimental foreign matter to the extent practicable.

f. Drying of Painted Metal

The maximum practicable time shall be allowed for paint to dry before recoating or exposure. No drier shall be added to paint on the job unless specifically called for in the Specifications for the paint. No painted metal shall be subjected to immersion before the paint is dried through. Paint shall be protected from rain, condensation, contamination, and freezing until dry, to the fullest extent practicable.

g. Handling of Painted Steel

Painted steel shall not be handled until the paint has dried, except for necessary handling in turning for painting or stacking for drying.

Paint which is damaged in handling shall be scraped off and touched-up with the same number of the coats and kinds of paint as were previously applied to the steel.

Painted steel shall not be loaded for shipment or shipped until it is dry.

Precautions shall be taken to minimize damage to paint films resulting from stocking members.

5. Measurement of Dry Film Thickness of Paints

a. Instrumentation

Dry paint film thickness shall be measured using Pull-Off (Type 1) or Fixed Probe (Type 2) Magnetic Gages. Type 1 gages include Tinsley, Elcometer,

Microtest and Inspector models. Type 2 gage include Elcometric, Minitector, General Electric, Verimeter and Accuderm models.

b. Calibration

1. Type 1 (Pull-Off) Magnetic Gages

Measure the coating thickness on a series of reliable standards covering the expected range of paint thickness. Record the calibration correction either plus (+) or minus (-) required at each standard thickness. To guard against gage drift during use, re-check occasionally with one or more of the standards.

When the gage adjustment has drifted so far that large corrections are needed, it is advisable to re-adjust closer to the standard values and re-calibrate.

For Type 1 gages, the preferred basic standards are small, chromeplated steel panels that may be available from the National Bureau of Standards in coating thickness from 12.70 mm to 203.20 mm.

Plastic shims of certified thickness in the appropriate ranges may also be used to calibrate the gages. The gage is held firmly enough to press the shim tightly against the steel surface. Record the calibration correction as above.

2. Type 2 (Fixed Probe) Magnetic Gages

Shims of plastic or non-magnetic metals laid on the appropriate steel base (at least 76.2 x 76.2 x 3.2 mm) are suitable working standards. These gages are held firmly enough to press the shim tightly against the steel surface. One should avoid excessive pressure that might indent the plastic or, on a blast cleaned surface, might impress the steel peaks into the undersurface of the plastic.

The National Bureau of Standards – standards panels shall not be used to calibrate Type 2 gages.

c. Measurement Procedures

To determine the effect of the substrate surface condition on the gage readings, access is required to some unpainted areas.

Repeated gage readings, even at points close together, may differ considerably due to small surface irregularities. Three gage readings should therefore be made for each spot measurement of either the substrate or the paint. Move the probe a short distance for each new gage reading. Discard any unusually high or low gage reading that cannot be repeated consistently. Take the average of the three gage readings as the spot measurement.

#### 1. Measurement with Type 1 (Pull-Off) Gage

Measure (A), the bare substrate, at a number of spots to obtain a representative average value. Measure (B), the dry paint film, at the specified number of spots.

Correct the (A) and (B) gage readings or averages as determined by calibration of the gage. Subtract the corrected readings (A) from (B) to obtain the thickness of the paint above the peaks of the surface.

#### 2. Measurement with Type 2 (Fixed Probe) Gage

Place a standard shim of the expected paint thickness on the bare substrate that is to be painted. Adjust the gage in place on the shim so that it indicates the known thickness of the shim.

Confirm the gage setting by measuring the shim at several other areas of the bare substrate. Re-adjust the gage as needed to obtain an average setting representative of the substrate.

With the gage adjustment as above, measure the dry paint film at three points. The gage readings indicate the paint film thickness at the three points. The gage readings indicate the paint thickness above the peaks of the surface profile.

Re-check the gage setting at frequent intervals during a long series of measurements. Make five separate spot measurements spaced evenly over each section of the structure 9.29 square metres in area, or of other area as may be specified. The average of five spot measurements for each such section shall not be less than the specified thickness. No single spot measurement (average of three readings) in any section shall be less than 80% of the specified thickness.

Since paint thickness is usually specified (or implied) as a minimum, greater thickness that does not cause defects of appearance or functions such as mud cracking, wrinkling, etc., is permitted unless otherwise specified.

d. Special Notes

All of the above magnetic, if properly adjusted and in good condition, are inherently accurate to within +15% of the true thickness of the coating.

Much larger, external errors may be caused by variations in method of use of the gages or by unevenness of the surface of the substrate or of the coating. Also, any other film present on the steel (rust or mill scale or even a blast cleaned profile zone) will add to the apparent thickness of the applied paint film.

The surface of the paint and the probe of the gage must be free from dust, grease and other foreign matter in order to obtain close contact of the probe with the paint and also to avoid adhesion of the magnet. The accuracy of the measurement will be affected if the coating is tacky or excessively soft.

The magnetic gages are sensitive to geometrical discontinuities of the steel, as at holes, corners or edges. The sensitivity to edge effects and discontinuities varies from gage to gage. Measurements closer than 25.4 mm from the discontinuity may not be valid unless the gage is calibrated specifically for that location.

Magnetic gage readings also may be affected by proximity to another mass of steel close to the body of the gage, by surface curvature and presence of other magnetic fields.

All of the magnets or probe must be held perpendicular to the painted surface to produce valid measurements.

#### **403.3.24 Clean-up**

Upon completion and before final acceptance, the Contractor shall remove all falsework, falsework piling down to at least 609.6 mm below the finished ground line, excavated or unused materials, rubbish and temporary buildings. He shall replace or renew any fences damaged and restored in an acceptable manner all property, both public and private, which may have been damaged during the prosecution of the work and shall leave the work

site and adjacent highway in a neat and presentable condition, satisfactory to the Engineer. All excavated material or falsework placed in the stream channel during construction shall be removed by the Contractor before final acceptance.

#### 403.4 Method of Measurement

##### 403.4.1 Unit Basis

The quantity of structural steel to be paid for shall be the number of kilos complete in place and accepted. For the purpose of measurement for payment components fabricated from metals listed in (1) below, such as casting, alloy steels, steel plates, anchor bolts and nuts, shoes, rockers, rollers, pins and nuts, expansion dams, roadway drains and souppers, welds metal, bolts embedded in concrete, cradles and brackets, posts, conduits and ducts, and structural shapes for expansion joints and pier protection will be considered as structural steel.

Unless otherwise provided, the mass of metal paid for shall be computed and based upon the following mass:

##### 1. Unit Density kg/m<sup>3</sup>

Aluminum, cast or rolled	2771.2
Bronze or copper alloy	8585.9
Copper sheet	8938.3
Iron, cast	7128.2
Iron, malleable	7528.7
Lead, sheet	11229
Steel, cast or rolled, including alloy copper bearing and stainless	7849
Zinc	7208.3

##### 2. Shapes, Plates Railing and Flooring

The mass of steel shapes and plates shall be computed on the basis of their nominal mass and dimensions as shown on the approved shop drawings, deducting for copes,

cuts and open holes, exclusive of rivets holes. The mass of all plates shall be computed on the basis of nominal dimensions with no additional for overrun.

The mass of railing shall be included as structural steel unless the Bill of Quantities contains as pay item for bridge railing under Item 401, Railings.

The mass of steel grid flooring shall be computed separately.

### 3. Casting

The mass of casting shall be computed from the dimensions shown on the approved drawings, deducting for open holes. To this mass will be added 5 percent allowable for fillets and overruns. Scale mass may be substituted for computed mass in the case of castings of small complex parts for which accurate computations of mass would be difficult.

### 4. Miscellaneous

The mass of erection bolts, shop and field paint, galvanizing the boxes, crates and other containers used for shipping, together with sills, struts, and rods used for supporting members during the transportation, bridge hardware as defined in Subsection 402.2.2 excluding steel plates and bearings, connectors used for joining timber members, nails, spikes and bolts, except anchor bolts will be excluded.

### 5. Rivets Heads

The mass of all rivet heads, both files and shop, will be assumed as follows:

<b>Diameter of rivet (mm)</b>	<b>kg per 100 heads</b>
12.7	1.80
15.9	3.20
19.0	5.44
22.2	8.16
25.4	11.80
28.6	16.33



31.7	21.8
------	------

## 6. High-Strength Bolts

High-strength steel bolts shall be considered for purpose of payment, the same as rivets of the same diameter, with the mass of the bolt heads and nuts the same as the corresponding rivet heads.

## 7. Welds

The mass of shop and field fillet welds shall be assumed as follows:

Size of Weld (mm)	kg per linear metre
6.3	0.984
7.9	1.213
9.5	1.771
12.7	2.690
5.9	3.936
19.0	5.379
22.2	7.314
25.4	9.774

The mass of other welds will be computed on the basis of the theoretical volume from dimensions of the welds, with an addition of 50 mass percent as an allowance for overrun.

## 8. Other Items

The quantities of other Contract Items which enter into the completed and accepted structure shall be measured for payment in the manner prescribed for the Items involved.

### **403.4.2 Lump Sum Basis**

Lump sum will be the basis of payment unless noted otherwise in the bidding documents. No measurements of quantities will be made except as provided in Subsection 403.5.1 (4).

## **403.5 Basis of Payment**

### **403.5.1 Structural Steel**

#### 1. Furnished, Fabricated and Erected

The quantity, determined as provided above, shall be paid for at the contract unit price per kilogram for “Structural Steel, furnished, fabricated and erected”, which price and payment shall constitute full compensation for furnishing, galvanizing, fabricating, radiographing, magnetic particle inspection, delivering, erecting ready for use, and painting all steel and other metal including all labor, equipment, tools and incidentals necessary to complete the work, except as provided in Subsections 403.5.2, 403.5.3 and 403.5.4.

#### 2. Furnished and Fabricated

When a quantity and unit price for “Structural Steel, furnished and fabricated” are shown in the Bill of Quantities, the quantity, determined as provided above, will be paid for at the contract unit price per kilogram which price and payment shall be full compensation for furnishing, galvanizing, fabricating, radiographing, magnet particle inspection, shop painting and delivering the structural steel and other metal free of charges at the place designated in the Special Provisions and for all labor, equipment, tools and incidentals necessary to complete the work, save erection and except as provided in Subsection 403.5.2, 403.5.3 and 403.5.4.

#### 3. Erected

When a quantity and unit price for “Structural Steel Erected” are shown in the Bill of Quantities, the quantity, determined as provided above, will be paid for at the said contract unit price per kilogram which price and payment shall be full compensation for unloading all the structural steel and other metal, payment of any demurrage charges, transporting to the bridge site, erecting, magnetic particle inspection and radiographing, complete ready for use including furnishing and applying the field paint including all labor, equipment, tools and incidentals necessary to complete the work, save furnishing and fabrication, and except as provided in Subsections 403.5.2, 403.5.3 and 403.5.4.

#### 4. Lump Sum

When the Bill of Quantities calls for lump sum price for “Structural Steel, furnished, fabricated and erected”, the Item will be paid for at the contract lump sum price and payment shall be full compensation for furnishing, fabricating and erecting material and for all work herein before prescribed in connection therewith, including all labor, equipment, tools and incidentals necessary to complete the work, except as provided in Subsections 403.5.2, 403.5.3 and 403.5.4.

The estimate of the mass of structural steel shown on the Plans is approximate only and no guarantee is made that it is the correct mass to be furnished. No adjustment in the contract price will be made if the mass furnished is more or less than estimated mass.

If changes in the work are ordered by the Engineer, which vary the mass of steel to be furnished, the lump sum payment shall be adjusted as follows:

- a. The value per kilogram of the increase or decrease in mass of structural steel involved in the change shall be determined by dividing the contract lump sum amount by the estimate of mass shown on the Plans. The adjusted contract lump sum payment shall be the contract lump sum plus or minus the value of the steel involved in the change, and no additional compensation shall be made on account of said change.
- b. Full-size members which are tested in accordance with the Specifications when such tests are required by the Contract, shall be paid for at the same rate as for comparable members in the structure. Members which fail to meet the Contract requirements, and members rejected as a result of test shall not be paid for.

#### **403.5.2 Material Considered as Structural Steel**

For the purpose of Subsection 403.5.1 and unless otherwise shown on the Plans, castings, forgings, special alloy steels and steel plates, wrought iron, and structural shapes of expansion joints and pier protection shall be considered as structural steel except that when quantities and unit price for certain alloy steels, forgings, castings or other specific categories of metal are called for in the Bill of Quantities, the mass of such selected material, determined as provided above, shall be paid for at the respective contract unit price per kilogram for “Structural Steel (Alloy steel, forgings, castings, and/or other category), furnished and fabricated, and erected” or “Structural Steel (Subsection 403.4.1), furnished and fabricated” as named in the Bill of Quantities.

### **403.5.3 Other Items**

The quantities of all other Contract Items which enter into the completed and accepted structure shall be paid for at the contract unit prices for the several Pay Items as prescribed for the Items involved.

### **403.5.4 Payment as Reinforcing Steel**

When the Bill of Quantities does not contain a pay item for structural steel, the quantities of metal drains, scuppers, conduits, ducts and structural shapes for expansion joints and pier protection, measured as provided above will be paid for as Reinforcing Steel under Item 404.

Payment will be made under:

Pay Item Number	Description	Unit of Measurement
403 (1)	Structural Steel, furnished, fabricated and erected	kilogram
403 (2)	Structural Steel, furnished, fabricated and erected	kilogram
403 (3)	Structural Steel, furnished, fabricated	Kilogram
403 (4)	Structural Steel, furnished, fabricated	Kilogram

403 (5)	Structural Steel erected	Kilogram
403 (6)	Structural Steel erected	Kilogram
403 (7)	Structural Steel, furnished, fabricated and erected	kilogram

## **ITEM 404 – REINFORCING STEEL**

### **404.1 Description**

This Item shall consist of furnishing, bending, fabricating and placing of steel reinforcement of the type, size, shape and grade required in accordance with this Specification and in conformity with the requirements shown on the Plans or as directed by the Engineer.

### **404.2 Material Requirements**

Reinforcing steel shall meet the requirements of item 710, Reinforcing Steel and Wire Rope.

### **4.4.3 Construction Requirements**

#### **404.3.1 Order Lists**

Before materials are ordered, all order lists and bending diagrams shall be furnished by the Contractor, for approval of the Engineer. The approval of order lists and bending diagrams by the Engineer shall in no way relieve the Contractor of responsibility for the correctness of such lists and diagrams. Any expense incident to the revisions of materials furnished in accordance with such lists and diagrams to make them comply with the Plans shall be borne by the Contractor.

#### **404.3.2 Protection of Material**

Steel reinforcement shall be stored above the surface of the ground upon platforms, skids, or other supports and shall be protected as far as practicable from mechanical injury and surface deterioration caused by exposure to conditions producing rust. When placed in the work, reinforcement shall be free from dirt, detrimental rust, loose scale, paint, grease, oil, or other foreign materials. Reinforcement shall be free from injurious defects such as cracks and

laminations. Rust, surface seams, surface irregularities or mill scale will not be cause for rejection, provided the minimum dimensions, cross sectional area and tensile properties of a hand wire brushed specimen meets the physical requirements for the size and grade of steel specified.

### 404.3.3 Bending

All reinforcing bars requiring bending shall be cold-bent to the shapes shown on the Plans or required by the Engineer. Bars shall be bent around a circular pin having the following diameters (D) in relation to the diameter of the bar (d):

Nominal diameter, d, mm	Pin diameter (D)
10 to 20	6d
25 to 28	8d
32 and greater	10d

Bends and hooks in stirrups or ties may be bent to the diameter of the principal bar enclosed therein.

### 404.3.4 Placing and Fastening

All steel reinforcement shall be accurately placed in the position shown on the Plans or required by the Engineer and firmly held there during the placing and setting of the concrete. Bars shall be tied at all intersections except where spacing is less than 300mm in each directions, in which case, alternate intersections shall be tied. Ties shall be fastened on the inside.

Distance from the forms shall be maintained by means of stays, blocks, ties, hangers, or other approved supports, so that it does not vary from the position indicated on the Plans by more than 6mm. Blocks for holding reinforcement from contact with the forms shall be precast mortar blocks of approved shapes and dimensions. Layers of bars shall be separated by precast mortar blocks or by other equally suitable devices. The use of pebbles, pieces of broken stone or brick, metal pipe and wooden blocks shall not be permitted. Unless otherwise shown on the Plans or required by the Engineer, the minimum distance between bars shall be 40mm. Reinforcement in any member shall be placed and then inspected and approved by the Engineer before the placing of concrete begins. Concrete placed in violation of this provision may be rejected and removal may be required. If fabric reinforcement is shipped in rolls, it shall be straightened before being placed. Bundled bars shall be tied together at not more than 1.8m intervals.

### 404.3.5 Splicing

All reinforcement shall be furnished in the full lengths indicated on the Plans. Splicing of bars, except where shown on the Plans, will not be permitted without the written approval of the Engineer. Splices shall be staggered as far as possible and with a minimum separation of not less than 40 bar diameters. Not more than one-third of the bars may be spliced in the same cross-section, except where shown on the Plans.

Unless otherwise shown on the Plans, bars shall be lapped a minimum distance of:

Splice Type	Grade 40 min. lap	Grade 60 min. lap	But not less than
Tension	24 bar dia	36 bar dia	300 mm
Compression	20 bar dia	24 bar dia	300 mm

In lapped splices, the bars shall be placed in contact and wired together. Lapped splices will not be permitted at locations where the concrete section is insufficient to provide minimum clear distance of one and one-third the maximum size of coarse aggregate between the splice and the nearest adjacent bar. Welding of reinforcing steel shall be done only if detailed on the Plans or if authorized by the Engineer in writing. Spiral reinforcement shall be spliced by lapping at least one and a half turns or by butt welding unless otherwise shown on the Plans.

#### **404.3.6 Lapping of Bar Mat**

Sheets of mesh or bar mat reinforcement shall overlap each other sufficiently to maintain a uniform strength and shall be securely fastened at the ends and edges. The overlap shall not be less than one mesh in width.

#### **404.4 Method of Measurement**

The quantity of reinforcing steel to be paid for will be the final quantity placed and accepted in the completed structure.

No allowance will be made for tie-wires, separators, wire chairs and other material used in fastening the reinforcing steel in place. If bars are substituted upon the Contractor's request and approved by the Engineer and as a result thereof more steel is used than specified, only the mass specified shall be measured for payment.

No measurement or payment will be made for splices added by the Contractor unless directed or approved by the Engineer.

When there is no item for reinforcing steel in the Bill of Quantities, costs will be considered as incidental to the other items in the Bill of Quantities.

#### **404.5 Basis of Payment**

The accepted quantity, measured as prescribed in Section 404.4, shall be paid for at the contract unit price for Reinforcing Steel which price and payment shall be full compensation for furnishing and placing all materials, including all labor, equipment, tools and incidentals necessary to complete the work prescribed in this Item.

Payment will be made under:

Pay Item Number	Description	Unit of Measurement
404	Reinforcing Steel	Kilogram

### **ITEM 405 – STRUCTURAL CONCRETE**

#### **405.1 Description**

##### **405.1.1 Scope**

This Item shall consist of furnishing, bending, placing and finishing concrete in all structures except pavements in accordance with this Specification and conforming to the lines, grades, and dimensions shown on the Plans. Concrete shall consist of a mixture of Portland Cement, fine aggregate, coarse aggregate, admixture when specified, and water mixed in the proportions specified or approved by the Engineer.

##### **405.1.2 Classes and Uses of Concrete**

Five classes of concrete are provided for in this Item, namely: A, B, C, P and Seal. Each class shall be used in that part of the structure as called for on the Plans.

The classes of concrete will generally be used as follows:

Class A – All superstructures and heavily reinforced substructures. The important parts of the structure included are slabs, beams, girders, columns, arch ribs, box culverts, reinforced abutments, retaining walls, and reinforced footings.



Class B – Footings, pedestals, massive pier shafts, pipe bedding, and gravity walls, unreinforced or with only a small amount of reinforcement.

Class C – Thin reinforced sections, railings, precast R.C. piles and cribbing and for filler in steel grid floors.

Class P – Prestressed concrete structures and members.

Seal – Concrete deposited in water.

## 405.2 Material Requirements

### 405.2.1 Portland Cement

It shall conform to all the requirements of Subsection 311.2.1.

### 405.2.2 Fine Aggregate

It shall conform to all the requirements of Subsection 311.2.2.

### 405.2.3 Coarse Aggregate

It shall conform all the requirements of Subsection 311.2.3 except that gradation shall conform to Table 405.1.

Table 405.1 – Grading Requirements for Coarse Aggregate

Sieve Designation		Mass Percent Passing				
Standard Mm	Alternate US Standard	Class A	Class B	Class C	Class P	Class Seal
63	2-1/2"		100			
50	2"	100	95 – 100			
37.5	1-1/2"	95 – 100	-			100

25	1"	-	35 – 70		100	95 – 100
19.0	¾"	35 – 70	-	100	95 – 100	-
12.5	½"	-	10 – 30	90 – 100	-	25 – 60
9.5	3/8"	10 – 30	-	40 – 70	20 – 55	-
4.75	No.4	0 - 5	0 - 5	0 – 15*	0 – 10*	0 – 10*

\* The measured cement content shall be within plus (+) or minus (-) 2 mass percent of the design cement content.

#### **405.2.4 Water**

It shall conform to the requirements of Subsection 311.2.4

#### **405.2.5 Reinforcing Steel**

It shall conform to the requirements of Item 710, Reinforcing Steel and Wire Rope.

#### **405.2.6 Admixtures**

Admixtures shall conform to the requirements of Subsection 311.2.7

#### **405.2.7 Curing Materials**

Curing materials shall conform to the requirements of Subsection 311.2.8.

#### **405.2.8 Expansion Joint Materials**

Expansion joint materials shall be:

1. Preformed Sponge Rubber and Cork, conforming to AASHTO M 153.
2. Hot-Poured Elastic Type, conforming to AASHTO M 173.
3. Preformed Fillers, conforming to AASHTO M 213.

**405.2.9 Elastomeric Compression Joint Seals**

These shall conform to AASHTO M 220.

**405.2.10 Elastomeric Bearing Pads**

These shall conform to AASHTO M 251 or Item 412 – Elastomeric Bearing Pads.

**405.2.11 Storage of Cement and Aggregates**

Storage of cement and aggregates shall conform to all the requirements of Subsection 311.2.10.

**405.3 Sampling and Testing of Structural Concrete**

As work progresses, at least one (1) sample consisting of three (3) concrete cylinder test specimens, 150 x 300mm (6 x 12 inches), shall be taken from each seventy five (75) cubic meters of each class of concrete or fraction thereof placed each day.

Compliance with the requirements of this Section shall be determined in accordance with the following standard methods of AASHTO:

Sampling of fresh concrete	T 141
Weight per cubic metre and air content (gravi-	
Metric) of concrete	T 121
Sieve analysis of fine and coarse aggregates	T 27
Slump of Portland Cement Concrete	T 119
Specific gravity and absorption of fine aggregate	T 84

Tests for strength shall be made in accordance with the following:

Making and curing concrete compressive and	
flexural tests specimens in the field	T 23
Compressive strength of molded concrete	
Cylinders	T 22

## 405.4 Production Requirements

### 405.4.1 Proportioning and Strength of Structural Concrete

The concrete materials shall be proportioned in accordance with the requirements for each class of concrete as specified in Table 405.2, using the absolute volume method as outlined in the American Concrete Institute (ACI) Standard 211.1. "Recommended Practice for Selecting Proportions for Normal and Heavyweight Concrete". Other methods of proportioning may be employed in the mix design with prior approval of the Engineer. The mix shall either be designed or approved by the Engineer. A change in the source of materials during the progress of work may necessitate a new mix design.

The strength requirements for each class of concrete shall be as specified in Table 405.2.

Table 405.2 - Composition and Strength of Concrete for Use in Structures

Class Of Concrete	Minimum Cement Content Per m <sup>3</sup>  kg (bag**)	Maximum Water/ Cement Ratio  kg/kg	Consistency  Range in Slump  mm (inch)	Designated  Size of Coarse Aggregate  Square Opening Std. mm	Minimum Compressive  Strength of 150x300mm Concrete Cylinder Specimen at 28 days, MN/m <sup>2</sup> (psi)
A	360  (9 bags)	0.53	50 – 100  (2 – 4)	37.5 – 4.75  (1-1/2" – No. 4)	20.7  (3000)

B	320	0.58	50 – 100	50 – 4.75	16.5
	(8 bags)		(2 – 4)	(2” – No. 4)	(2400)
C	380	0.55	50 – 100	12.5 – 4.75	20.7
	(9.5 bags)		(2 – 4)	(1/2” – No. 4)	(3000)
P	440	0.49	100 max.	19.0 – 4.75	37.7
	(11 bags)		(4 max.)	(3/4” – No. 4)	(5000)
Seal	380	0.58	100 – 200	25 – 4.75	20.7
	(9.5 bags)		(4 - 8)	(1” – No. 4)	(3000)

\* The measured cement content shall be within plus or minus 2 mass percent of the design cement content.

\*\* Based on 40 kg/bag

#### 405.4.2 Consistency

Concrete shall have a consistency such that it will be workable in the required position. It shall be of such a consistency that it will flow around reinforcing steel but individual particles of the coarse aggregate when isolated shall show a coating of mortar containing its proportionate amount of sand. The consistency of concrete shall be gauged by the ability of the equipment to properly place it and not by the difficulty in mixing and transporting. The quantity of mixing water shall be determined by the Engineer and shall not be varied without his consent. Concrete as dry as it is practical to place with the equipment specified shall be used.

#### 405.4.3 Batching

Measuring and batching of materials shall be done at a batching plant.

1. Portland Cement

Either sacked or bulk cement may be used. No fraction of a sack of cement shall be used in a batch of concrete unless the cement is weighed. All bulk cement shall be weighed on an approved weighing device. The bulk cement weighing hopper shall be properly sealed and vented to preclude dusting operation. The discharge chute shall not be suspended from the weighing hopper and shall be so arranged that cement will neither be lodged in it nor leak from it.

Accuracy of batching shall be within plus (+) or minus (-) 1 mass percent.

2. Water

Water may be measured either by volume or by weight. The accuracy of measuring the water shall be within a range of error of not more than 1 percent.

3. Aggregates

Stockpiling of aggregates shall be in accordance with Subsection 311.2.10. All aggregates whether produced or handled by hydraulic methods or washed, shall be stockpiled or binned for draining for at least 12 hours prior to batching. Rail shipment requiring more than 12 hours will be accepted as adequate binning only if the car bodies permit free drainage. If the aggregates contain high or non-uniform moisture content, storage or stockpile period in excess of 12 hours may be required by the Engineer.

Batching shall be conducted as to result in a 2 mass percent maximum tolerance for the required materials.

4. Bins and Scales

The batching plant shall include separate bins for bulk cement, fine aggregate and for each size of coarse aggregate, a weighing hopper, and scales capable of determining accurately the mass of each component of the batch.

Scales shall be accurate to one-half (0.5) percent throughout the range used.

5. Batching

When batches are hauled to the mixer, bulk cement shall be transported either in waterproof compartments or between the fine and coarse aggregate. When cement is placed in contact with moist aggregates, batches will be rejected unless mixed within 1-1/2 hours of such contact. Sacked cement may be transported on top of the aggregates.

Batches shall be delivered to the mixer separate and intact. Each batch shall be dumped cleanly into the mixer without loss, and, when more than one batch is carried on the truck, without spilling of material from one batch compartment into another.

## 6. Admixtures

The Contractor shall follow an approved procedure for adding the specified amount of admixture to each batch and will be responsible for its uniform operation during the progress of the work. He shall provide separate scales for the admixtures which are to be proportioned by weight, and accurate measures for those to be proportioned by volume. Admixtures shall be measured into the mixer with an accuracy of plus or minus three (3) percent.

The use of Calcium Chloride as an admixture will not be permitted.

### **405.4.4 Mixing and Delivery**

Concrete may be mixed at the site of construction, at a central point or by a combination of central point and truck mixing or by a combination of central point mixing and truck agitating. Mixing and delivery of concrete shall be in accordance with the appropriate requirements of AASHTO M 157 except as modified in the following paragraphs of this section, for truck mixing or a combination of central point and truck mixing or truck agitating. Delivery of concrete shall be regulated so that placing is at a continuous rate unless delayed by the placing operations. The intervals between delivery of batches shall not be so great as to allow the concrete in place to harden partially, and in no case shall such an interval exceed 30 minutes.

In exceptional cases and when volumetric measurements are authorized, for small project requiring less than 75 cu.m. per day of pouring, the weight proportions shall be converted to equivalent volumetric proportions. In such cases, suitable allowance shall be made for variations in the moisture condition of the aggregates, including the bulking effect in the fine aggregate. Batching and mixing shall be in accordance with ASTM C 685, Section 6 through 9.

Concrete mixing, by chute is allowed provided that a weighing scales for determining the batch weight will be used.

For batch mixing at the site of construction or at a central point, a batch mixer of an approved type shall be used. Mixer having a rated capacity of less than a one-bag batch shall not be used. The volume of concrete mixed per batch shall not exceed the mixer's nominal capacity as shown on the manufacturer's standard rating plate on the mixer except that an overload up to 10 percent above the mixer's nominal capacity may be permitted, provided concrete test data for strength, segregation, and uniform consistency are satisfactory and provided no spillage of concrete takes place. The batch shall be so charge into the drum that a portion of the water shall enter in advance of the cement and aggregates. The flow of water shall be uniform and all water shall be in the drum by the end of the first 15 seconds of the mixing period. Mixing time shall be measured from the time all materials, except water, are in the drum. Mixing time shall not be less than 60 seconds for mixers having a capacity of 1.5m<sup>3</sup> or less. For mixers having a capacity greater than 1.5m<sup>3</sup>, the mixing time shall not be less than 90 seconds. If timing starts, the instant the skip reaches its maximum raised position, 4 seconds shall be added to the specified mixing time. Mixing time ends when the discharge chute opens.

The mixer shall be operated at the drum speed as shown on the manufacturer's name plate on the mixer. Any concrete mixed less than the specified time shall be discarded and disposed off by the Contractor at his own expenses.

The timing device on stationary mixers shall be equipped with a bell or other suitable warning device adjusted to give a clearly audible signal each time the lock is released. In case

of failure of the timing device, the Contractor will be permitted to continue operations while it is being repaired, provided he furnishes an approved timepiece equipped with minute and second hands. If the timing device is not placed in good working order within 24 hours, further use of the mixer will be prohibited until repairs are made.

Retempering concrete will not be permitted. Admixtures for increasing the workability, for retarding the set, or for accelerating the set or improving the pumping characteristics of the concrete will be permitted only when specifically provided for in the Contract, or authorized in writing by the Engineer.

#### 1. Mixing Concrete: General

Concrete shall be thoroughly mixed in a mixer of an approved size and type that will insure a uniform distribution of the materials throughout the mass.

All concrete shall be mixed in mechanically operated mixers. Mixing plant and equipment for transporting and placing concrete shall be arranged with an ample auxiliary installation to provide a minimum supply of concrete in case of breakdown of machinery or in case the normal supply of concrete is disrupted. The auxiliary supply of concrete shall be sufficient to complete the casting of a section up to a construction joint that will meet the approval of the Engineer.

Equipment having components made of aluminum or magnesium alloys, which would have contact with plastic concrete during mixing, transporting or pumping of Portland Cement concrete, shall not be used.

Concrete mixers shall be equipped with adequate water storage and a device of accurately measuring and automatically controlling the amount of water used.

Materials shall be measured by weighing. The apparatus provided for weighing the aggregates and cement shall be suitably designed and constructed for this purpose. The accuracy of all weighing devices except that for water shall be such that successive quantities can be measured to within one percent of the desired amounts. The water measuring device shall be accurate to plus or minus 0.5 mass percent. All measuring devices shall be subject to the approval of the Engineer. Scales and measuring devices shall be tested at the expense of the Contractor as frequently as the Engineer may deem necessary to insure their accuracy.

Weighing equipment shall be insulated against vibration or movement of other operating equipment in the plant. When the entire plant is running, the scale reading at cut-off shall not vary from the weight designated by the Engineer more than one mass percent for cement, 1-1/2 mass percent for any size of aggregate, or one (1) mass percent for the total aggregate in any batch.

#### 2. Mixing Concrete at Site

Concrete mixers may be of the revolving drum or the revolving blade type and the mixing drum or blades shall be operated uniformly at the mixing speed recommended by the manufacturer. The pick-up and throw-over blades of mixers shall be restored or replaced when any part or section is worn 20mm or more below the original height of the manufacturer's design. Mixers and agitators which have an accumulation of hard concrete or mortar shall not be used.



When bulk cement is used and volume of the batch is 0.5m<sup>3</sup> or more, the scale and weigh hopper for Portland Cement shall be separate and distinct from the aggregate hopper or hoppers. The discharge mechanism of the bulk cement weigh hopper shall be interlocked against opening before the full amount of cement is in the hopper. The discharging mechanism shall also be interlocked against opening when the amount of cement in the hopper is underweight by more than one (1) mass percent or overweight by more than 3 mass percent of the amount specified.

When the aggregate contains more water than the quantity necessary to produce a saturated surface dry condition, representative samples shall be taken and the moisture content determined for each kind of aggregate.

The batch shall be so charged into the mixer that some water will enter in advance of cement and aggregate. All water shall be in the drum by the end of the first quarter of the specified mixing time.

Cement shall be batched and charged into the mixer so that it will not result in loss of cement due to the effect of wind, or in accumulation of cement on surface of conveyors or hoppers, or in other conditions which reduce or vary the required quantity of cement in the concrete mixture.

The entire content of a batch mixer shall be removed from the drum before materials for a succeeding batch are placed therein. The materials composing a batch except water shall be deposited simultaneously into the mixer.

All concrete shall be mixed for a period of not less than 1-1/2 minutes after all materials, including water, are in the mixer. During the period of mixing, the mixer shall operate at the speed for which it has been designed.

Mixers shall be operated with an automatic timing device that can be locked by the Engineer. The time device and discharge mechanics shall be so interlocked that during normal operation no part of the batch will be charged until the specified mixing time has elapsed.

The first batch of concrete materials placed in the mixer shall contain a sufficient excess of cement, sand, and water to coat inside of the drum without reducing the required mortar content of the mix. When mixing is to cease for a period of one hour or more, the mixer shall be thoroughly cleaned.

### 3. Mixing Concrete at Central Plant

Mixing at central plant shall conform to the requirements for mixing at the site.

### 4. Mixing Concrete in Truck

Truck mixers, unless otherwise authorized by the Engineer, shall be of the revolving drum type, water-tight, and so constructed that the concrete can be mixed to insure a uniform distribution of materials throughout the mass. All solid materials for the concrete shall be accurately measured and charged into the drum at the proportioning plant. Except as subsequently provided, the truck mixer shall be equipped with a device by which the quantity of water added can be readily verified. The mixing water may be added directly to the batch, in which case a tank is not required. Truck mixers may be required to be provided with a means of which the mixing time can be readily verified by the Engineer.

The maximum size of batch in truck mixers shall not exceed the minimum rated capacity of the mixer as stated by the manufacturer and stamped in metal on the mixer. Truck mixing, shall, unless other-wise directed be continued for not less than 100 revolutions after all ingredients, including water, are in the drum. The mixing speed shall not be less than 4 rpm, nor more than 6 rpm.

Mixing shall begin within 30 minutes after the cement has been added either to the water or aggregate, but when cement is charged into a mixer drum containing water or surface wet aggregate and when the temperature is above 32°C, this limit shall be reduced to 15 minutes. The limitation in time between the introduction of the cement to the aggregate and the beginning of the mixing may be waived when, in the judgement of the Engineer, the aggregate is sufficiently free from moisture, so that there will be no harmful effects on the cement.

When a truck mixer is used for transportation, the mixing time specified in Subsection 405.4.4 (3) at a stationary mixer may be reduced to 30 seconds and the mixing completed in a truck mixer. The mixing time in the truck mixer shall be as specified for truck mixing.

#### 5. Transporting Mixed Concrete

Mixed concrete may only be transported to the delivery point in truck agitators or truck mixers operating at the speed designated by the manufacturers of the equipment as agitating speed, or in non-agitating hauling equipment, provided the consistency and workability of the mixed concrete upon discharge at the delivery point is suitable point for adequate placement and consolidation in place.

Truck agitators shall be loaded not to exceed the manufacturer's guaranteed capacity. They shall maintain the mixed concrete in a thoroughly mixed and uniform mass during hauling.

No additional mixing water shall be incorporated into the concrete during hauling or after arrival at the delivery point.

The rate of discharge of mixed concrete from truck mixers or agitators shall be controlled by the speed of rotation of the drum in the discharge direction with the discharge gate fully open.

When a truck mixer or agitator is used for transporting concrete to the delivery point, discharge shall be completed within one hour, or before 250 revolutions of the drum or blades, whichever comes first, after the introduction of the cement to the aggregates. Under conditions contributing to quick stiffening of the concrete or when the temperature of the concrete is 30°C, or above, a time less than one hour will be required.

#### 6. Delivery of Mixed Concrete

The Contractor shall have sufficient plant capacity and transportation apparatus to insure continuous delivery at the rate required. The rate of delivery of concrete during concreting operations shall be such as to provide for the proper handling, placing and finishing of the concrete. The rate shall be such that the interval between batches shall not exceed 20 minutes. The methods of delivering and

handling the concrete shall be such as will facilitate placing of the minimum handling.

**405.5 Method of Measurement**

The quantity of structural concrete to be paid for will be the final quantity placed and accepted in the completed structure. No deduction will be made for the volume occupied by pipe less than 100mm (4 inches) in diameter or by reinforcing steel, anchors, conduits, weep holes or expansion joint materials.

**405.6 Basis of Payment**

The accepted quantities, measured as prescribed in Section 405.5, shall be paid for at the contract unit price for each of the Pay Item listed below that is included in the Bill of Quantities.

Payment shall constitute full compensation for furnishing, placing and finishing concrete including all labor, equipment, tools and incidentals necessary to complete the work prescribed in the item.

Payment will be made under:

Pay Item Number	Description	Unit of Measurement
405 (1)	Structural Concrete, Class A	Cubic Meter
405 (2)	Structural Concrete, Class B	Cubic Meter
405 (3)	Structural Concrete, Class C	Cubic Meter
405 (4)	Structural Concrete, Class P	Cubic Meter
405 (5)	Seal Concrete	Cubic Meter

**ITEM 409 – WELDED STRUCTURAL STEEL**

**409.1 Description**

This work shall consist of the joining of structural steel members with welds of the type, dimensions, and design shown on the Plans and in accordance with the Specifications.

It is the intent of this Specification to provide for work of a quality comparable to that required under the Standard Specifications for Welded Highway and Railway Bridges of the American Welding Society. In case of dispute or for situations not adequately provided for in this Specification, those designated Standard

Specifications shall be considered as the final authority and shall govern except as amended by the Special Provisions.

Welding of Structural Steel shall be done only when shown on the Plans or authorized in writing by the Engineer.

## **409.2 Materials Requirements**

Steel base metal to be welded shall be open-hearth or electric furnace steel conforming to AASHTO M 183.

All arc-welding electrodes shall conform to the requirements of American Welding Society Specifications. Electrodes shall be of classification numbers E7016, E7018 or E7028 as required for the positions, type of current and polarity, and other conditions of intended use, and to conform to any special requirements indicated on the Plans.

Filler material to be used in the repair or strengthening of old structures or for joining new parts to existing steel members, shall be adopted to the material to be welded and may depart from the foregoing requirements only if agreed by the Engineer.

## **409.3 Construction Requirements**

### **409.3.1 Equipment**

#### **409.3.1.1 General**

All items of equipment for welding and gas cutting shall be so designed and manufactured and in such condition as to enable qualified welders to follow the procedures and attain the results prescribed in this Specification.

#### **409.3.1.2 Arc-Welding Equipment**

Welding generators and transformers shall be designed expressly for welding. They shall be capable of delivering steady currents adjustable through a range ample for the work requirements. They shall respond automatically and quickly to changes in power requirements due to variations in arc length and shall deliver full current promptly on striking an arc.

Welding cable shall have sufficient conductivity to avoid overheating and inadequate current at the arc and shall be effectively insulated against welding circuit voltage. Earth or ground connections and circuits shall be secured and adequate to carry the welding currents.

Electrode holders shall grip the electrode firmly and with good electrical contact.

Approved automatic welding heads may be used, with suitable auxiliary handling equipment to provide automatic instead of manual control of electrode and welding arc.

#### **409.3.1.3 Gas-Cutting Equipment**

Torches and tips shall be of proper size and type of the work at hand. Suitable regulators shall afford the welder complete control over the pressure and rate of flow of each gas.

#### **409.3.1.4 Protective Equipment**

All personnel protective equipment shall conform to the American Standard Association Code for such equipment.

The Contractor shall enforce the use of approved accessories necessary for the protection and convenience of the welders and for the proper and efficient execution of the work.

Suitable protection against the light of the arc shall be maintained by the Contractor when arc-welding operation might be viewed within harmful range by persons other than the actual welders and inspectors.

## **409.3.2 Welding**

### **409.3.2.1 General**

Welding shall be performed by the metal-arc process, using the electrodes specified with either direct or alternating current.

Surfaces to be welded shall be smooth, uniform and free from fins, tears, and other defects which would adversely affect the quality of the weld. Edges of material shall be trimmed by machining, chipping, grinding, or machine gas-cutting to produce a satisfactory welding edge wherever such edge is thicker than: 13 mm for sheared edge of material; 16 mm for toes of angles or rolled shapes (other than wide flange sections); 25 mm for universal mill plate or edges of flange sections.

The width of root face used, shall be not more than 1.5 mm for parts less than 10 mm in thickness nor more than 3 mm for parts 10 mm or more in thickness.

Butt welds shall be proportioned so that their surface contours will lie in gradual transition curves. For butt welded joints between base metal parts of unequal thickness, a transition shall be provided on a slope or level not greater than 1 in 2.5 to join the offset surfaces. This transition may be provided by sloping the surface of the weld metal or by bevelling the thicker part or by combination of these two methods.

Surfaces to be welded shall be free from loose scale, slag, rust, grease or other material that will prevent proper welding. Mill scale that withstands vigorous wire brushing or a light film of drying oil or rust inhibitive coating may remain. Surfaces within 50 mm of any weld location shall be free of any paint or other material that would prevent proper welding or produce objectionable fumes while welding.

No operation or actual welding or gas-cutting shall be performed on a member while it is carrying live load stress or while subject to shock and vibration and from moving loads. Welding and gas-cutting shall cease in advance of the application of such loads.

#### **409.3.2.2 Welders**

All welding shall be done by approved competent and experienced and fully qualified welders.

#### **409.3.2.3 Preparation of Materials for Welding**

Dimensional tolerance, straightness and flatness of the structural shapes and plates shall be within the limits prescribed in this Specification.

Structural steel which is to be welded shall preferably not be painted until all welding is completed.

Preparation of edges by gas-cutting shall, wherever practicable, be done by machine gas-cutting. Machine gas-cutting edges shall be substantially as smooth and regular as those produced by edge planning and shall be left free of slag. Manual gas cutting shall be permitted only where machine gas-cutting is not practicable and with the approval of the Engineer. The edge resulting from manual gas-cutting shall be inspected and smoothed with special care. All

re-entrant corners shall be filleted to a radius at least 19 mm. The cut lines shall not extend beyond the fillet and all cutting shall follow closely the line prescribed.

#### **409.3.2.4 Assembly**

The parts to be joined by fillet welds shall be brought into a close contact as practicable, and no event shall be separated more than 5 mm. If the separation is 1.5 mm or greater, the leg of the fillet weld shall be increased by the amount of separation. The separation between faying surfaces of lap joints and of butt joints landing on a backing structure shall not exceed 1.5 mm. The fit of joints which are not sealed by welds throughout their length shall be sufficiently close to exclude water after painting. Where irregularities in rolled shape or plates, after straightening, do not permit contact within the above limits, the procedure necessary to bring the material within these limits shall be subject to the approval of the Engineer.

Cutting parts to be joined by butt welds shall be carefully aligned. Where the parts are effectively restrained against bending due to eccentricity or alignment, a maximum offset of 10 percent of the thickness or the thinner part joined, but in no case more than 3 mm, may be permitted as a departure from the theoretical alignment. In connecting alignment in such cases, the parts shall not be drawn into a greater slope than two degrees (1 in 30). Measurement of offset shall be between centerline of parts unless otherwise shown on the Plans.



When parts abutting edge to edge differ in thickness, the joint shall be of such form that the slope of either surface through the transition zone does not exceed 1 in 2.5, the thicker part being bevelled, if necessary.

Members to be welded shall be brought into correct alignment and held in position by bolts, clamps, wedges, guy lines, struts, other suitable devices or tack welds until welding has been completed. The use of jigs and fixtures is recommended where practicable. Such fastening devices as may be used shall be adequate to insure safety.

Plug and slot welds may be used to transmit shear in a lap joint or to prevent the buckling or separation of lapped parts.

The diameter of the hole for a plug weld shall not be less than the thickness of the part containing it plus 8 mm nor shall it be greater than 2.25 times the thickness of the weld.

The minimum center spacing of plug welds shall be four times the diameter of the hole.

The length of the slot for a slot weld not exceed ten times the thickness of the weld. The width of the slot shall not be less than the thickness of the part containing it plus 8 mm nor shall it be greater than 2.25 times the thickness of the weld.

The ends of the slot shall be semicircular or shall have the corners rounded to a radius not less than the thickness of the part containing it, except those ends which extend to the edge of the part.

The minimum spacing of lines of slot welds in a direction transverse to their length shall be 4 times the width of the slot.

The minimum center to center spacing in a longitudinal direction on any line shall be 2 times the length of the slot.

The thickness of plug or slot welds in material 16 mm or less in thickness shall be equal to the thickness of the material.

In material over 16 mm in thickness, it shall be at least one-half the thickness of the material but not less than 16 mm.

Tack welds, located where the final welds will later be made, shall be subject to the same quality requirements as the final weld. Tack welds shall be as small as practicable and where encountered in the final welding, shall be cleaned and fused thoroughly with the final weld. Defective, cracked or broken tack welds shall be removed before final welding.

Members or component parts of structures shall be assembled and matchmarked prior to erection to insure accurate assembly and adjustment of position on final erection. Painted assembly marks shall be removed from any surface to be welded.

#### **409.3.2.5 Control of Distortion and Shrinkage Stresses**

In assembling and joining parts of a structure or a built-up member and in welding reinforcing parts to existing members, the procedure and sequence of welding shall be such as will avoid distortion and minimize shrinkage stresses.

As far as practicable, long parallel lines of welding on a part or member shall be executed concurrently, and all welds shall be deposited in a sequence that will balance the applied heat of welding on various sides as much as possible while the welding progresses.

Before the commencement of welding on a structural member in which severe shrinkage stresses or distortion are likely to occur, a complete program for welding sequence and distortion control shall be submitted to the Engineer and shall be subject to his approval.

The direction of the general progression in welding on a member shall be from points where parts are relatively fixed in position, with respect to each other, toward points which have a greater relative freedom of movement.

Where part or member is to be welded on both ends into a rigid structure or assembly, the connection at which the greatest shrinkage will occur in the direction of the length of the part or member, shall be made while the part or member is free to move in the direction of the shrinkage; and the connection involving the least shrinkage shall be made last.

A weld designed to sustain tensile stress shall be made in such a way that their welding is being performed at any point, all parts that would offer restraint against shrinkage can shrink, deform or move enough to preclude serious shrinkage stresses.

In welding of built-up members of heavy sections, particularly those T or H-shapes where the flanges are considerably heavier than the stems or webs, and in any case where the component parts are 38 mm or greater in thickness, special care shall be exercised during welding to avoid weld cracking. In the welding of members of such heavy section, the temperature of contiguous areas about a welding operation shall be equal, and not less than 55°C. If necessary, the lighter parts shall be heated while the weld is cooling, to keep the temperature of contiguous parts substantially equal.

In the fabrication of cover-plated beams and built-up members, all shop splices in each component part shall be made before such component part is welded to other parts of the member.

In making all butt-welded splices in rolled shapes and in making butt-welded field splices in built-up sections (such as in H or I-sections) the sequence and procedure of welding shall be such as to take into account unequal amounts of expansion or contraction in the parts being welded. The procedure and sequence shall be such that while the weld and the heated base metal are contracting at any point, any part of the member that would furnish restraint against such contraction can move or shrink enough to prevent the shrinkage of the heated metal from producing harmful internal stresses. The procedure and sequence that is used for

making such splices shall be planned in advance in full detail and submitted to the Engineer and shall be subject to his approval.

The ends of all butt welds in flanges of beams and girders shall be made with extension bars regardless of the thickness of such flanges.

Welding shall not be done when surfaces are wet from condensation or rain which is falling on the surfaces to be welded; nor during periods of high winds unless the welding operator and the work are properly protected.

#### **409.3.2.6 Technique of Arch-Welding**

The welding current shall conform with respect to voltage and current (and polarity, of direct current is used) to the recommendations of the manufacturer of the electrode being used, as indicated in the instructions that are included with each container of electrodes.

Arc lengths and electrical potential and current shall be suited to the thickness of material, type of groove and other circumstances attendant to the work.

The maximum size of electrode permitted shall be 5 mm with the following exceptions:

1. The maximum size for flat position welding of all passes except the root pass shall be 8 mm.
2. The maximum size for horizontal fillet welds shall be 6 mm.

The electrode for the single pass fillet weld and for the root passes of all multiple layer welds in all cases shall be of the proper size to insure thorough fusion and penetration with freedom from slag inclusions.

A single layer of the weld metal, whether deposited in one pass or made up of several parallel beads, shall not exceed 3 mm in thickness except that the bead at the root may be 6 mm in thickness if the position of welding and the viscosity of the weld metal permit control of the latter so that it does not over flow upon unfused base metal.

The maximum size of fillet weld which may be made in one pass shall be 8 mm except that for vertical welds made upward the maximum size made in one pass shall be 13 mm.

In vertical welding the first root pass shall be formed from the bottom upward. Succeeding passes may be formed by any technique that will fulfill the requirements of the Specification and Plans.

The electrode manipulation during welding shall insure that:

1. Complete fusion between the base metal and the deposited weld metal is obtained.
2. The melted base metal is replaced by weld metal so that no undercut remains along the edges of the finished weld.
3. The molten weld metal floats all slag, oxide and gases to the surface behind the advancing arc.

Each time the arc is started, either to begin a weld or to continue partly completed weld, the arch shall be manipulated to obtain complete fusion of the deposited weld metal with the base metal and with any previously deposited weld metal, before any progression of the arc along the joint.

At the completion of a pass or weld, the arc shall be manipulated so as to fill the crater with sound metal.

Before welding over previously deposited metal, the slag shall be removed and the weld and adjacent base metal shall be brushed clean. This requirement shall apply not only to cratered areas but also when welding is resumed after any interruption. It shall not, however, restrict the making of plug and slot welds, in accordance with the following paragraphs.

In making plug welds the following techniques shall be used:

1. For flat welds, the arc shall be carried around the root of the joint and then weaved along a spiral path to the center of the hole, fusing and depositing a layer of weld metal in the root and bottom of the joint. The arc shall then be carried to the periphery of the hole, and the procedure repeated, fusing and depositing successive layers to fill the hole to the depth required. The slag covering the weld metal shall be kept molten, or nearly so, until the

weld is finished. If the arc is broken, except briefly for changing electrodes, the slag must be allowed to cool and shall be completely removed before restarting the weld.

2. For vertical welds, the arc shall be started at the root of the joint, at the lower side of the hole and carried upward on the zigzag path, depositing a layer about 5 mm thick on the exposed face at the thinner plate and fused to it and to the side of the hole. After cleaning the slag from the weld, other layers shall be similarly deposited to fill the hole to the required depth.
3. For overhead welds, the procedure shall be the same as for flat welds except that the slag shall be allowed to cool and shall be completely removed after depositing each successive layer until the hole is filled to the required depth.

Slot welds shall be made with a technique similar to that specified above for plug welds, except that if the length of the slot exceeds three times the width, or if the slot extends to the edges of the part of the technique specified above for making plug welds shall be followed for the type of flat position welds.

#### 409.3.2.7 Details of Welds

The following tabulation shows that the relation between weld size and the maximum thickness of material on which various sizes of fillet welds may be used:

Size of Fillet Weld	Maximum Thickness of Part
5 mm	13 mm
6 mm	19 mm
8 mm	32 mm
10 mm	51 mm
13 mm	152 mm
16 mm over	152 mm

The maximum size of fillet weld that may be used along the edge of material 6 mm or

more in thickness shall be 1.5 mm less than the thickness of the material.

The minimum effective length of fillet weld shall be four times its size and in no case less than 38 mm.

Fillet welds terminating at the corners of parts or members shall, wherever practicable, be turned continuously full size around the corners for a distance not less than twice the nominal size of the weld.

Intermittent fillet welds, preferably, shall not be used. They shall be permitted only where the required weld area is less than that of a continuous fillet weld of the minimum size. If used on main members, they shall be chain intermittent welds. In all other cases, chain intermittent welding is preferable to staggered intermittent welding.

Spacing of intermittent fillet welds shall be measured between the center of the weld segments. The spacing shall conform to the following requirements unless calculated stresses between the parts require closer spacing:



1. At the end of members, there shall preferably be continuous longitudinal fillet welds at least as long as the width of the element or member being connected.
2. The clear spacing in the direction of stress of stitch welds that connect plates to other plates or to shapes shall not exceed:
  - a. For compression members ....10 times the thickness of the thinner part but not more than 300 mm.
  - b. For tension members ..... 14 times the thickness of the thinner part but not more than 300 mm.

The spacing transverse to the direction of stress shall not exceed 24 times the thickness of the thinner part connected.

3. For members composed of two or more rolled shapes in contact with one another, the longitudinal spacing of stitch welds shall not exceed 600 mm.

Fillet welds in holes or slots may be used to transmit shear in lap joints or to prevent the buckling or separation of lapped parts. The fillet welds in a hole or slot may overlap.

Seal welding shall preferably be accomplished by a continuous weld combining the function of sealing and strength, changing sections only as the required strength may necessitate.

Exposed faces of welds shall be made reasonably smooth and regular, shall conform as closely as practicable to the design requirements and shall not at any place be inside the intended cross-section. Weld dimension in excess of the design requirements shall not be a cause for rejection, but in case excess weld metal involves serious malformation, such work shall be rejected.

All fillet welds shall be of acceptable types. All fillet welds that carry reversed stresses running in a direction perpendicular to their longitudinal axis shall be of the concave type or the 0-gee type when the fillet weld is flushed with the edge of a member. When one of these types is specifically indicated on the Plans for a weld, it shall be of that type.

Butt welds shall preferably be made with a slight reinforcement, except as may be otherwise provided, and shall have no defects. The height of reinforcement shall be not more

than 3 mm.

All butt welds, except produced with aid of backing material, shall have the root of the initial layer chipped out or otherwise cleaned to sound metal and welded in accordance with the requirements of the Specification. Butt welds made with the use of a backing of the same materials as the base metal shall have the weld metal thoroughly fused with the backing materials.

Ends of butt welds shall be extended past the edges of the parts joined by means of extension bars providing a similar joint preparation and having a width not less than the thickness of the thicker part jointed; or for material 19 mm or less in thickness, the ends of the welds shall be chipped or cut down to solid metal and side welds applied to fill out the ends to the same reinforcement as the face of the welds. Extension bars shall be removed upon completion and cooling of the weld and the ends of the weld made smooth and flush with the edges of the abutting parts.

#### **409.3.2.8 Quality of Welds**

Weld metal shall be solid throughout except that very small gas pockets and small inclusions of oxide or slag may be accepted if well dispersed and if none exceeds 1.5 mm in greatest dimension, and if the sum of the greatest dimensions of all such defects of weld metal area does not exceed 15 mm in an area of 10 cm<sup>2</sup>.

There shall be complete fusion between the weld metal and the base metal and between successive passes throughout the joint.

Welds shall be free from overlap and the base metal free from undercutting. All craters shall be filled to the full cross- section of the welds.

#### **409.3.2.9 Correction**

In lieu of rejection of an entire piece of member containing welding which is unsatisfactory or indicates inferior workmanship, the following corrective measures may be permitted by the Engineer whose specific approval shall be obtained for making each correction:

1. Removal of part or all of the welds shall be affected by chipping, grinding or gas-gouging.
2. Defective or unsound welds shall be corrected either by removing and replacing the welds, or as follows:
  - a. Excessive convexity – Reduce to size by removal of excess weld metal.
  - b. Shrinkage crack in base metal, craters and excessive porosity – Remove defective portion of base and weld metal down to sound metal and deposit additional weld metal.
    - c. Undercutting, undersize and excessive concavity – Clean and deposit additional weld metal.
    - d. Overlapping and lack of fusion – Remove and replace the defective length of weld.
    - e. Slag inclusion – Remove those parts of the weld containing slag and fill with weld metal.
    - f. Removal of adjacent base metal during welding – Clean and form full size by depositing additional weld metal.
3. Where corrections require the depositing of additional weld metal, the electrode

used shall be smaller than the electrode used in making the original weld.

4. A cracked weld shall be removed throughout its length, unless by the use of acid etching, magnetic inspection or other equally positive means, the extent of the crack can be ascertained to be limited, in which case sound metal 50 mm or more beyond each end of the crack need not be removed.
5. In removing defective parts of a weld, the gas-gouging, chipping or grinding shall not extend into the base metal any substantial amount beyond the depth of the web penetration unless cracks or other defects exist in the base metal.
6. Where the work performed subsequent to the making of a deficient weld has rendered the weld inaccessible or has caused new conditions which would make the correction of the deficiency dangerous or ineffectual, the original condition shall be restored by renewal of welds or members, or both before making the necessary corrections, or else the deficiency shall be compensated by additional work according to a revised design approved by the Engineer.
7. Caulking of welds shall not be done.

8. Before adding weld metal or rewelding, the surfaces shall be cleaned thoroughly. Where incomplete fusion is disclosed by chipping, grinding or gas gouging, to correct defects, that part of the weld shall be removed and rewelded.

#### **409.3.2.10 Stress Relieving**

Peening to reduce residual stress of multi-layer welds may be used only if authorized and ordered by the Engineer. Care shall be exercised to prevent overpeening which may cause overlapping, scaling, flecking or excessive cold working of weld and base metal.

#### **409.3.2.11 Cleaning and Protective Coatings**

Painting shall not be done until the work has been accepted and shall be in accordance with the Specification. The surface to be painted shall be cleaned of spatter, rust, loose scale, oil and dirt. Slag shall be cleaned from all welds.

Welds that are to be galvanized shall be treated to remove every particle of slag.

#### **409.3.2.12 Identification**

The operator shall place his identification mark with crayon, or paint, near the welds made by him.

#### **409.3.2.13 Inspection**

On completion of the welding work, inspection shall be carried out by an Inspector appointed by the Engineer.

The size and contour of welds shall be measured with suitable gauges. The inspector shall identify with a distinguishing mark all welds that he has inspected and accepted.

The Contractor shall remove and replace, or correct as instructed, all welds found defective or deficient. He shall also replace all methods found to produce inferior results, with

methods which will produce satisfactory work.

In the event that fault welding or the removal for rewelding of faulty welding shall damage the base metal, the Contractor shall remove and replace the damaged material.

#### **409.4 Measurement and Payment**

Unless otherwise provided in the Special Provisions, welded structural steel structures shall not be measured and paid for separately, but the cost thereof shall be considered as included in the contract price for other items.

## **ITEM 1013 – CORRUGATED METAL ROOFING**

### 1013.1 Description

This Item shall consist of furnishing all plant equipment, tools, materials and labor required to properly perform and complete the corrugated metal roofing, together with related accessories such as ridge/hip rolls, valleys, gutters and flashing, when called for on Plans all in conformity with his Specifications.

### 1013.2 Material Requirements

#### 1013.2.1 Corrugated and Plain Galvanized Iron Sheets

Corrugated galvanized iron (G.I.) sheets, including plain G.I. sheets for roofing accessories, shall be cold-rolled meeting ASTM A 153 and with spelter coating of zinc of not less than 0.381 kg/m<sup>2</sup> (1.25 ounces/square foot), conforming to ASTM A 525 OR pns 67:1985.

Unless

otherwise specified or shown on Plans roofing sheets shall be gauge 26 (0.48 mm thick) and provided in long span sizes to minimize end laps. Sheets shall weigh not less than 3.74 kg/m<sup>2</sup> and shall be marked or stamped showing the gauge, size, amount of zinc coating, brand and name of manufacturer. Test specimens shall stand being bent through 180° flat on itself without fracture of the base metal and without flaking of the zinc coating.

#### 1013.2.2 Strap Fasteners

Strap fasteners shall be gauge 26 G.I. 25 mm wide and sufficiently long to bend around up to the opposite face of purlin, with corners chipped off at the riveting ends.

#### 1013.2.3 Rivets, Washers and Burrs

Rivets and washers shall be galvanized mild iron. Rivets shall not be less than 5 mm in diameter and 10 mm in length. Washers shall not be less than 1.5 mm thick and 20 mm in outside diameter. Washer's inside diameter shall provide snug fit to the rivet.

#### 1013.2.4 Soldering Lead

Soldering lead shall have a composition of 50 percent tin and 50 percent lead, conforming to ASTM B 32.

Rivets and burrs for lap joints of gutters, downspouts and flashing shall be copper not less than 3.175 mm in diameter (No. 8).

#### 1013.2.5 Fabricated Metal Roofing Accessories

Ridge/hip rolls, valleys, flashing and counter flashings, gutters and downspouts, whenever required, shall be fabricated from plain G.I. sheets. Ridge/hip rolls, flashings and counter flashings shall be gauge 26. Valleys, gutters and downspouts shall be gauge 24 unless otherwise specified on Plans. Wire basket strainers shall be galvanized, gauge 24.

Roof ventilators, whenever required shall be fabricated from gauge 26 plain G.I. sheets and constructed to the dimensions and details shown on Plans.

#### 1013.3 Construction Requirements

##### 1013.3.1 Preparatory Work

Preparatory Work to the installation of the corrugated G.I. roofing, purlins should have been placed and spaced properly to fit the length of roofing sheets to be used such that the centerline of the purlins at end laps are 150 mm from the bottom line of end laps and intermediate purlins are placed equidistantly. Top of purlins should be at the same plane.

##### 1013.3.2 Installation of Corrugated G.I. Sheets

Installation of corrugated G.I. sheets with end laps shall start at the lower part of the roof and proceed towards the direction of monsoon wind with side laps of two-and-a-half (2-1/2) corrugations. End laps shall be 250 mm minimum. Each sheet shall be fastened temporarily by

1.83 mm diameter by 25 mm long galvanized flat head nails at valleys of corrugations covered by side or end laps.

Succeeding upper rows of corrugated G.I. sheets shall be installed in the same manner until the entire roof area is covered.

Valleys, ridge/hip rolls and flashings when required, shall be installed before fastening the roofing sheets with galvanized straps and rivets. One strap shall be riveted at each alternate corrugation at the gutter line, the ridge line and at end laps and the straps bent around and nailed to the purlins. Riveting at intermediate purlins between end laps shall be done at every fourth corrugation. Rivet shall be provided with a galvanized mild iron washer below and one lead and one galvanized iron washer above the sheet. Rivet shall be sufficiently long to permit



forming a hemispherical head. Riveting shall be done such that the lead washer shall be compressed to provide a watertight fit around the rivet.

### 1013.3.3 Installation of Roofing Accessories a) Ridge and Hip Rolls

Ridge and hip rolls shall lap at least 250 mm over roofing sheets and, together, shall be riveted at every second corrugation.

#### b) Valleys

Valleys shall lap at least 450 mm each way under the roofing sheets and shall be secured to the framework with galvanized nails, such nails placed below the roofing sheets. Rivets along side of the valley shall be at every second corrugation.

#### c) Flashing

Flashing, of gauge 26 plain G.I. sheets, unless otherwise specified, shall be installed along intersections of roofs with concrete or masonry walls in accordance with details shown on Plans. Flashing running parallel to sheet corrugation shall lap at least two corrugations with edge turned down. Flashing across sheet corrugation or at an angle thereto, shall lap at least 250 mm and the edge of flashing turned down at each corrugation. The vertical portion of flashing adjoining wall shall be at least 200 mm wide and provided with counter flashing. d) Counter Flashing

Counter flashing sheets of gauge 24 plain GI shall be built into preformed wedge-shape groove of concrete or masonry wall. The edge to be built into wall groove shall have a 25 mm strip bent 45 degrees and shall be sealed in the groove with cement mortar or caulking compound.

#### e) Reglets

Reglets when required per plans in connection with counter flashing shall be fabricated products approved by the Engineer, complete with fittings. Reglets shall be located not less than 200 mm or more than 40 mm above roofing. Reglet plugs shall be spaced not more than 300 mm on centers. Open-type reglets shall be filled with fiber board or other suitable separator to prevent crushing of the slot during installation. The counter flashing shall be inserted into the full depth of reglet and the reglet lightly punched- every 300' mm to crimp the reglet and the counter flashing together.

#### f) Gutters

Gutters, from gauge 24 plain G.I. sheets, shall be fabricated to the shape and dimensions indicated on the Plans. The rear side of the gutter shall have a 12.5 mm strip bent 30 degrees and shall be not less than 12.5 mm higher than the opposite side. Gutter joints shall be flat seam folded in the direction of flow and soldered evenly. Otherwise, gutter joints shall be lapped at least 25 mm, fastened together with 3.175 mm diameter (No.8) copper rivets and burrs, and sealed by soldering along both exposed edges of lap.

Gutter shall be attached to fascia board or roof nailer with galvanized nails or screws spaced at not more than 900 mm on centers and at a point slightly higher than leading edge of gutter. As additional support, gutter shall have plain G.I. strap hangers 25 mm wide fastened to roof

nailers by screw shank-type nails and riveted to the gutter's leading edge. Strap hangers shall be spaced at not more than 900 mm on centers. When shown on Plans that gutter is not fixed to fascia board or purlin, gutter shall be supported by wrought iron (W.I.) hangers not less than 4.75 mm thick and 19 mm wide spaced at not more than 900 mm on centers. W.I. hanger shall be fabricated to fit configuration of the gutter and attached to fascia board or purlin with two (2) No.8 flat head wood screws.

Gutter shall be installed with a pitch of 1 in 100 slope to downspout. g) Downspouts

1) Downspouts

Unless specified otherwise, downspouts shall be plain G.I., thickness fabricated to the dimensions shown on the Plans and installed at indicated locations. Downspout shall be secured to the wall with G.I. straps 25 mm wide, spaced at more than 1000 mm and anchored with concrete nails. Inlets of downspouts shall be fitted with gauge 14 wire basket strainers.

2) Unplasticized Polyvinyl Chloride Downspouts

When shown on Plans that downspouts are other than G.I. sheets, downspouts shall be unplasticized polyvinyl chloride (UPVC) pipes and fittings with dimensions indicated and conforming with ASTM D 3033 and D 3034. Joints shall be made with either solvent cement or rubber "O-rings" depending on the design of fitting for the joints. Rubber "O-rings" shall be neoprene type, heat and oil resistant, complying with ASTM F-477. Downspout shall be secured to adjoining wall with plain G.I. straps 25 mm wide and spaced at not more than 1000 mm.

g) Roof Ventilators

Roof ventilators, whenever shown on Plans shall be firmly secured to the roofing or roof structure by means of rivets, Roof ventilators installed on the roof at places other than the ridge shall be provided with adequate flashing around intersection with roofing to ensure watertight joints.

1013.3.4 Joints of G.I. Roofing Accessories a) Soldered Joints

Joints made by lapping coupled with riveting shall be rendered watertight by soldering. All edges of uncoated sheet metal to be soldered shall be pretinned before soldering. Soldering shall be done slowly with well heated iron in order to thoroughly heat the seam and sweat the solder completely through the full length of the seam. Upon completion of soldering, acid shall be neutralized by washing thoroughly with water.

b) Non-soldered Joints

Non-soldered joints of G.I. gutters, downspouts and flashings shall be done by flat lock seams. Two adjoining edges of lock seam shall be bent 90°. One bent strip shall be at least 15 mm wide and the connecting piece shall have a bent strip twice in width which shall be bent down over the upturned narrower strip and pressed together. Once properly interlocked, the joint shall be flattened such that the edge of the wider strip be concealed.

### 1013.3.5 Roof Installation on Metal Purlins

Installation on metal purlins shall follow the same procedure as that on wood purlins, except that fastening shall be done with thread-cutting, zinc-coated steel screws, No. 12 by 50 mm. having hexagonal heads and provided with neoprene washers. Screw holes shall be drilled using 5 mm (13/64") diameter bit.

### 1013.3.6 Water Leak Test

The completed roofing shall be tested for water tightness at side and end laps at joints of roofing sheets with ridge/hips rolls, valleys and flashings by means of water spray system. The water-spray system shall have nozzle which will deliver water pressure of 2 kg/cm<sup>2</sup> directly to the joint being tested in such manner and for a duration directed by the Engineer. All defective works as determined by this test shall be remedied by the contractor at his expense and the test shall be repeated until the work is found satisfactory.

### 1013.4 Method of Measurement

Roofing sheets shall be measured and paid for on an area basis in square meters or part thereof, such roofing sheets including all laps, fasteners and rivets as installed complete and accepted.

Ridge/hip rolls, flashings, valleys, gutters and down-spouts shall be measured in linear metre of completed and accepted work such measurement shall include necessary straps and fixings required for complete installation.

Roof ventilators shall be measured and paid for per unit completely installed and accepted.

The different pay Items under roofing work shall be designated the following number, description and unit of measure:

Pay Item Number	Description	Unit of Measurement
1013.2.1	Corrugated roofing, gauge 26	m <sup>2</sup>
1013.2.2	Fabricated metal roofing accessories:	
	a) Ridged/hip rolls, flashings, gutters and downspouts, gauge 26	1m
	b) Valleys, counter flashing gutter and	

	downspouts, gauge 24	1m
1013.2.3	Roof ventilators	each

#### 1013.5 Basis of Payment

Payment for completely installed and accepted roofing sheets and required fabricated metal roofing accessories shall be based on actual measurement and the corresponding contract unit price thereof. Payment based on contract unit price shall constitute full compensation.

### **ITEM 1014 - PREPAINTED METAL SHEETS**

#### 1014.1 Description

This Item shall consist of furnishing all pre-painted metal sheet materials, tools and equipment, plant including labor required in undertaking the proper installation complete as shown on the Plans and in accordance with this Specification.

#### 1014.2 Material Requirements

All pre-painted metal sheet and roofing accessories shall be oven baked painted true to profiles indicated on the •Plans.

##### 1014.2.1 Pre-Painted Roofing Sheets

Pre-painted roofing sheets shall be fabricated from cold rolled galvanized iron sheets specially tempered steel for extra strength and durability. It shall conform to the material requirements defined in PNS 67: 1985. Profile section in identifying the architectural moulded rib to, be used are as follows: Regular corrugated, Quad-rib, Tri-wave, Rib-wide, twin-rib, etc. Desired color shall be subject to the approval of the Architect/Engineer.

1014.2.2 Gutters, Valleys, Flashings Hip and Ridge roll shall be fabricated from gauge 24 (.600 mm thick) cold-rolled plain galvanized iron sheets specially tempered steel. Profile section shall be as indicated on the Plans.

1014.2.3 Fastening hardware shall be of galvanized iron straps and rivets. G.I. straps are of .500 mm thick x 16 mm wide x 267 mm long (gauge 26 x 5/8" x 10-1/2") and standard rivets.

1014.2.4 Base metal thickness shall correspond to the following gauge designation available locally as follows:

a) Base Metal Thickness      Designated Gauges

.400 mm thick Gauge 28

.500 mm thick Gauge 26

.600 mm thick Gauge 24

.800 mm thick Gauge 22

b) Protective Coatings      Thickness

1. Zinc 34.4 microns

(244 gm/m<sup>2</sup>) 2. Paint coatings

Top coat 15.20 microns Bottom coat 6.8 microns

c) Overall thickness with protective coats

d) .400 mm      .428-451 mm

.500 mm      .532-551 mm

.600 mm      .638-651 mm

e) Length of roofing sheets - available in cut to length long span length up to 18.29 meters f) Special length and thickness are available by arrangements.

### 1014.3 Construction Requirements

Before any installation work is commenced, the Contractor shall ascertain that the top faces of the purlins are in proper alignment. Correct the alignment as necessary in order to have the top faces of the purlins on an even plane.

#### 1014.3.1 Handling/Lifting/Positioning of Sheets

Sheets shall be handled carefully to prevent damage to the paint coating. Lift all sheets or sheet packs on to the roof frame with the overlapping down-turned edge facing towards the side of the roof where installation will commence, otherwise sheets will have to be turned end-to-end during installation.

#### 1014.3.2 Installation Procedure

1014.3.2.1 Start roofing installation by placing the first sheet in position with the downturned edge in line with other building elements and fastened to supports as recommended.

1014.3.2.2 Place the downturned edge of the next sheet over the edge of the first sheet, to provide side lap and hold the side lap firmly in place. Continue the same procedure for subsequent sheets until the whole roofing area is covered and/or (Adopt installation procedure provided in the instruction manual for each type of Architectural molded rib profile section).

1014.3.2.3 For walling applications follow the procedure for roofing. Allow a minimum end lap of 100 mm (4") for vertical walling.

#### 1014.3.3 Gutters, Valleys, Flashing ridge and Hip rolls

Gutters, valleys, flashing ridge and hip rolls shall be fastened where indicated on the Plans by self-tapping screws or galvanized iron straps and rivets.

#### 1014.3.4 End Laps

In case handling or transport consideration requires to use two or more end lapped sheets to provide full length coverage for the roof run, install each line of sheets from bottom to top or from eave line to apex of roof framing. Provide 150 mm minimum end lap.

#### 1014.3.5 Anchorage/Fastening

1014.3.5.1 Pre-painted steel roofing sheets shall be fastened to the wood purlins with standard length G.I. straps and rivets.

1014.3.5.2 For steel frame up to 4.5 mm thick use self drilling screw No. 12 by 35 mm long hexagonal head with neoprene washer.

1014.3.5.3 For steel support up to 5 mm thick or more use thread cutting screw No. 12 by 40 mm long hexagonal head with neoprene washer.

1014.3.5.4 Side lap fastener use self drilling screw NO.10 by 16 mm long hexagonal head with neoprene washer.

1014.3.5.5 Valley fastened to lumber and for walling use self-drilling wood screw No. 12 by 25 mm long hexagonal head with neoprene washer.

1014.3.5.6 Valleys fastened to steel supports use selfdrilling screws, hexagonal head with neoprene washer. Drill size is 5 mm diameter.

#### 1014.3.6 Cutting of Sheets

1014.3.6.1 In cutting pre painted steel roofing sheets and accessories to place the exposed color side down. Cutting shall be carried out on the ground and not over the top of other painted roofing product.

1014.3.6.2 Power cutting or drilling to be done or carried out on pre-painted products already installed or laid in position, the area around holes or cuts shall be masked to shield the paint from hot fillings.

#### 1014.3.7 Storage and Protection

Pre-painted steel roofing, walling products and accessories should be delivered to the jobsite in strapped bundles. Sheets and/or bundles shall be neatly stacked in the ground and if left in the open it shall be protected by covering the stack materials with loose tarpauline.

#### 1014.4 Method of Measurement

The work done under this Item shall be measured by actual area covered or installed with pre-painted steel roofing and/or walling in square meters and accepted to the satisfaction of the Engineer/Architect.

#### 1014.5 Basis of Payment

The area of pre-painted steel roofing and/or walling in square meters as provided in Section 1014 shall be paid for at the unit bid or contract unit price which payment shall constitute full compensation including labor, materials, tools and incidents necessary to complete this Item.

Payment shall be made under:

Pay Item Number	Description	Unit of Measurement
1014 (a)	Pre painted metal sheets	m2

## **PAINTING**

### **SCOPE OF WORK:**

- (a) The work covered by this section of the specification consists in the proper preparation of surfaces, the furnishing of all plant, labor, materials, tools, appliances, scaffolding and other necessary equipment and in performing all operations in connection with painting and varnishing work, complete in accordance with color scheme and as specified herein and subject to the terms and conditions of the contract.
- (b) This section of the specifications covers the complete painting and finishing of all wood surfaces, the painting of plasters, brick, concrete, stucco, unfinished metal and other surfaces throughout the interior and exterior of the building, and (or) other surfaces indicated on the color scheme and schedule, except where otherwise specified
- (c) Surface to be varnished:  
Unless otherwise specified in the color scheme approved by the PMO, or otherwise specified hereinafter, all wooden doors, transom sashes, transom frames, door trimmings or casing, window sill, wood handrails of stairs, wooden counters, counter cabinets and open shelving; also other wood surfaces and surfaces of other materials indicated as varnish finish (polished or satin) in the color scheme and (or) directed by the Engineer.
- (d) All paint materials shall meet the requirements of the specifications by the Standardizations Committee on Supplies and shall be delivered on the job in the original container, with labels intact and scales unbroken.
- (e) The use of ready mixed paint may be allowed in this project provided that all paint materials shall conform to the Standard Specifications No. 13 of the Philippine Government and that ready mixed paints shall be those listed under "Good Substitutes" only and (or) classified as "Good Quality" as certified by the Institute of Science and Technology.
- (f) The workmanship shall be the very best. All materials shall be applied under adequate illumination, evenly spread and smoothly flowed on without runs or sags.
- (g) Color scheme for the painting and varnishing of the whole building, complete, both inside and outside shall be furnished later to the contractor upon request. Color scheme and varnished samples required by this specifications and (or) by the PMO shall be submitted by the Contractor for approval at his own expense.



- (h) Paint shall be thoroughly stirred so as to keep the pigment evenly in suspension while paint is being supplied to rollers.
- (i) All painting and varnishing work shall be done in workmanship manner by skilled house painters and varnishers only.
- (j) In general and unless otherwise specified, and (or) instructed by the Engineer due to actual conditions on the job, not less than 48 hours' time shall elapse between application of succeeding coats.
- (k) Except where otherwise noted by specified, all paints shall be applied in three (3) coats (priming, body and finish).
- (l) The use of roller for paint application is required, except on inaccessible surfaces in which case the painter's brush (nylon brush) shall be used.
- (m) Surfaces which cannot be satisfactorily finished in the number of coats specified shall have such additional coats, or such preparatory coats and subsequent coats as may be required to produce satisfactory finished work.
- (n) Tinting colors for oil paint shall be colored-in-roll, ground in pure linsed oil, and of the highest grade obtainable.
- (o) Colors shall be non-fading.
- (p) Color pigments shall be sued to produce the exact shades of paint which shall conform to the approved color scheme of the building.

Except as otherwise noted, color of priming cost shall be lighter than the finish coat. The first coat shall be white.

## *Section VII. Drawings*



Republic of the Philippines  
Province of Camarines Norte  
Office of the Provincial Engineer  
Date:

PROJECT TITLE/LOCATION  
**CONSTRUCTION OF 2ND FLOOR  
BARRANGAY HALL  
OF WALACBANG P.N.C. 1711 G  
BRGY. WALACBANG PARACALE CAMARINES NORTE**

PREPARED BY  
**FRANCIS JACAL P. BORTER**  
ENGINEER/REGULATED

CHECKED BY  
**SAMUEL T. CANTO**  
C.E. - PLANNING DIVISION

RECOMMENDING AUTHORITY:  
**JOHN M. L. S. TOBIAS**  
PROVINCIAL ENGINEER

APPROVED BY  
**RICHARDE R. MADILLA**  
GOVERNOR

SHT. CONTINENTS  
AS SHOWN  
1  
3

SHT. NO.  
A  
3

# PERSPECTIVE

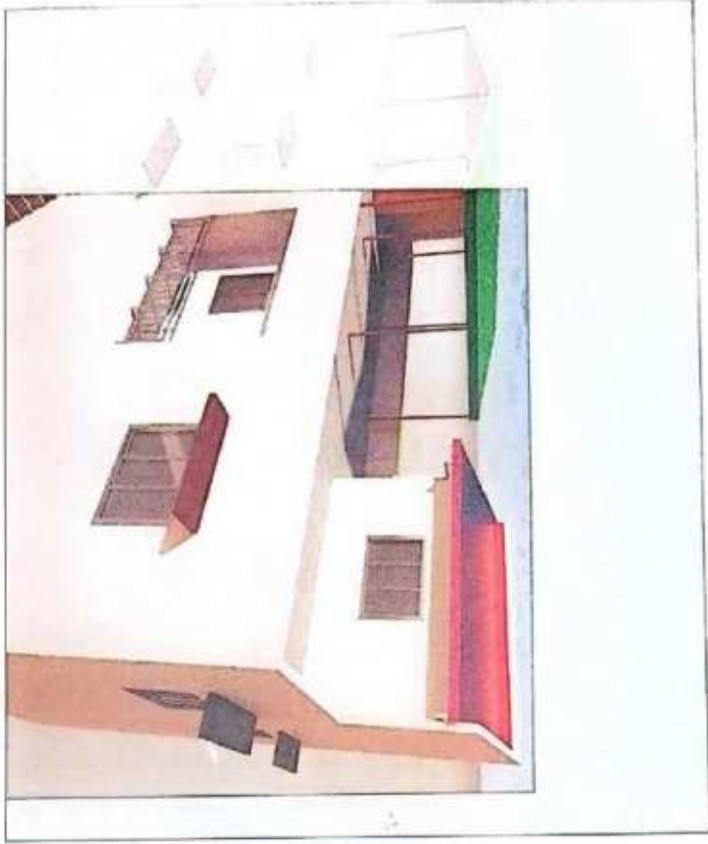

# LOCATION PLAN

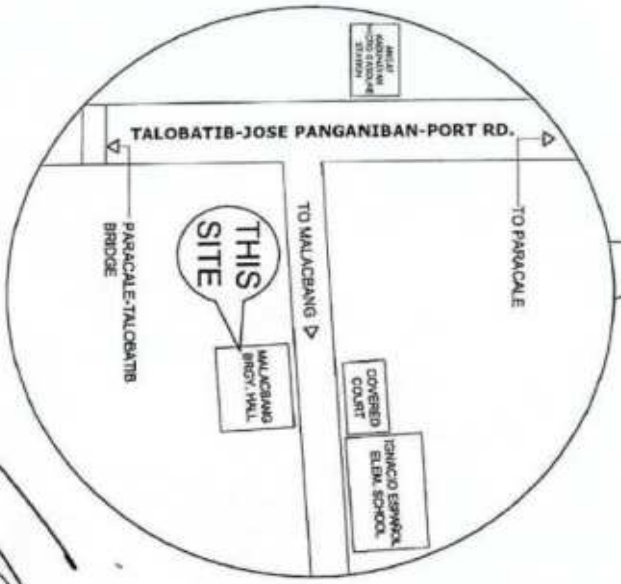

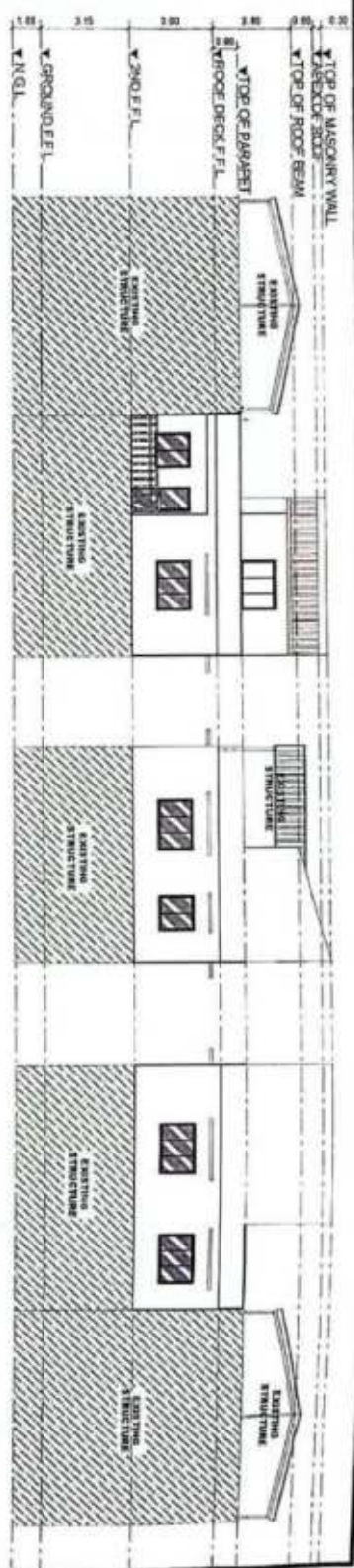

FRONT ELEVATION  
SCALE 1:150  
MTS

RIGHT-SIDE ELEVATION  
SCALE 1:150  
MTS

REAR ELEVATION  
SCALE 1:150  
MTS

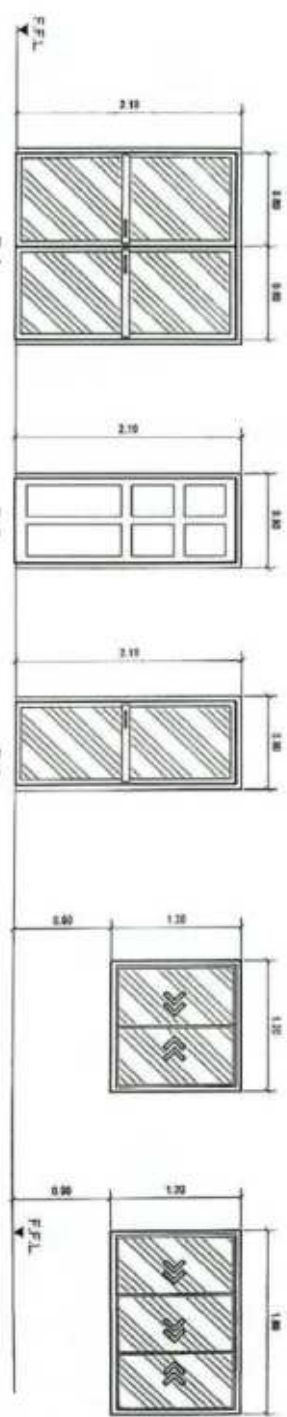

TWO-LEAF ALUMINUM FRAME DOOR  
W/ 2" THK. FIXED CLEAR GLASS &  
W/ COMPLETE ACCESSORIES  
1- SET

PANEL DOOR  
SOLID WOODEN PANEL  
W/ DOOR JAMB & W/  
COMPLETE ACCESSORIES  
2- SETS

SINGLE-LEAF ALUMINUM FRAME DOOR  
W/ 2" THK. FIXED CLEAR GLASS &  
W/ COMPLETE ACCESSORIES  
1- SET

SLIDING GLASS WINDOW - (2-5MM)  
POWDERED COATED WHITE COULANT  
W/ 2" THK. CLEAR GLASS & W/  
COMPLETE ACCESSORIES  
2- SETS

SLIDING GLASS WINDOW - (2-5MM)  
POWDERED COATED WHITE COULANT  
W/ 2" THK. CLEAR GLASS & W/  
COMPLETE ACCESSORIES  
5- SETS

SCHEDULE OF DOORS & WINDOWS  
SCALE: 1:40  
MTS

 Republic of the Philippines Philippine Council on Civil Engineering Regulation and Control Office of the Principal Engineer Date:	PROJECT UTILIZATION	PREPARED BY	CHECKED BY	RECOMMENDING APPROVAL	APPROVED BY	SPT. CONTAINS	SPT. NO.
	CONSTRUCTION OF 2ND FLOOR of PARRAYAT HALL BIGY MALACBANG, PAMPANGA COMMANDER'S HOME	FRANCIS LYCA P. BORTER ENGINEERING	SAMUEL T. DANTO CIVIL ENGINEERING	JOHN MARVIN S. TOBIAS CIVIL ENGINEER	RICHARDE R. PADILLA CONVENOR	AS SHOWN	2



Republic of Indonesia  
Ministry of Education, Culture and Sports  
Office of the Provincial Engineer  
Davao

PROJECT TITLE/NO:  
**CONSTRUCTION OF 2ND FLOOR  
BARANGAY HALL  
D.M.A.S.A.M.A.D**

DESIGNED BY:  
**FRANZEVOR F. BORTER**  
ENGINEER/ARCHITECT

CHECKED BY:  
**SAMUEL TAYNTO**  
OFF. ENGINEER/ARCHITECT

RECORDING APPROVAL:  
**JOHN MARIL S. TOBIAS**  
ENGINEER/ARCHITECT

APPROVED BY:  
**RICHARDE R. ADULLA**  
SUPERVISOR

BY: COURTESY  
**AS SHOWN**

DATE: 3/3

REFLECTED CEILING PLAN  
SCALE 1:100  
MKS

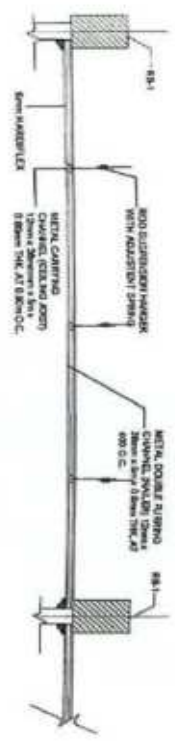
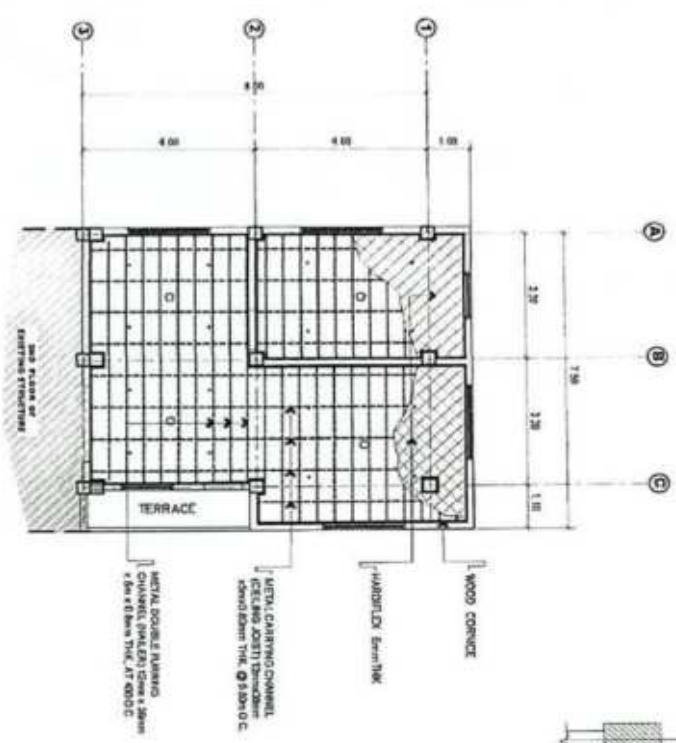

CEILING SECTION DETAIL  
SCALE 1:30 MKS

CEILING PERSPECTIVE  
MKS

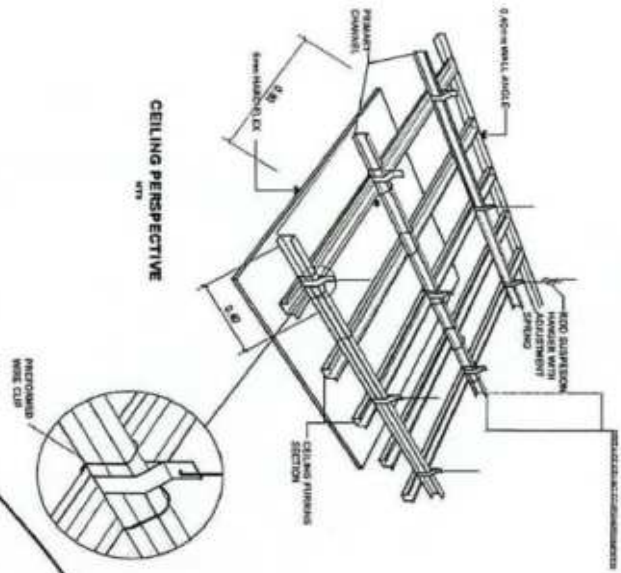





Republic of the Philippines  
 Province of Cavendish North  
 Office of the Provincial Engineer  
 Date

PROJECT INFORMATION  
**CONSTRUCTION OF 2ND FLOOR**  
**SAMPANGAY HALL**  
 OF P.A.C. S.M.U.  
 BRGY. MANAKANG, PARRALE CAMARINES NORTE

PREPARED BY  
 FRAUZE TLOM-FLOTER  
 ENGINEERING

CHECKED BY  
 SHILEE TRONTO  
 C.E. - RABROCKSON

RECOMMENDED APPROVAL  
 JOHN MARIANO S. TOBIAS  
 REGISTERED ENGINEER

APPROVED BY  
 RICARTE PADILLA  
 SUPERVISOR

SHT. COMMENTS  
 AS SHOWN

SHT. NO.  
 5  
 4

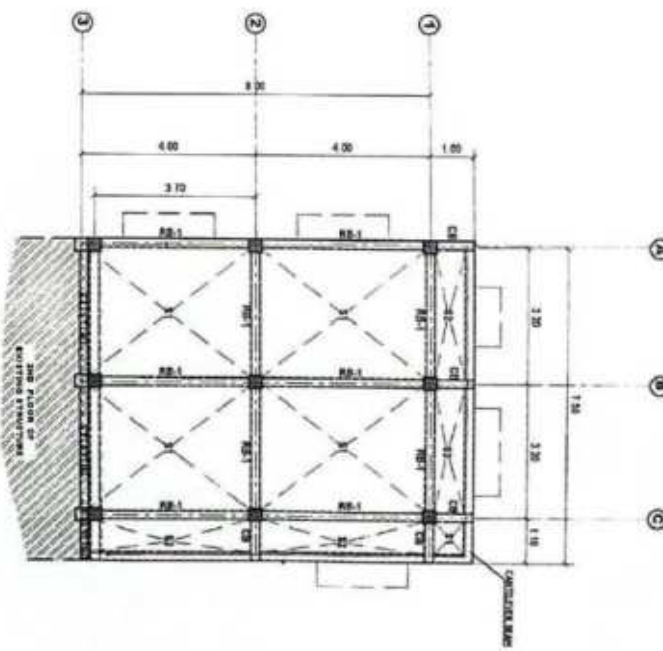
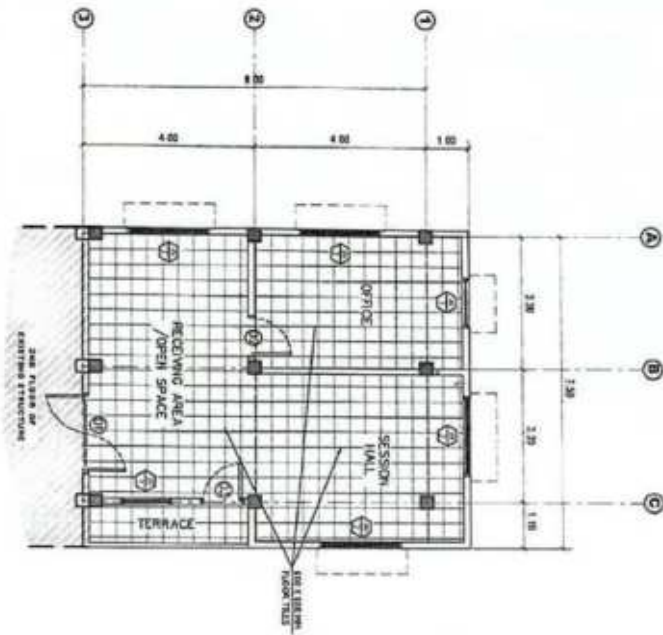

# SCHEDULE OF COLUMN

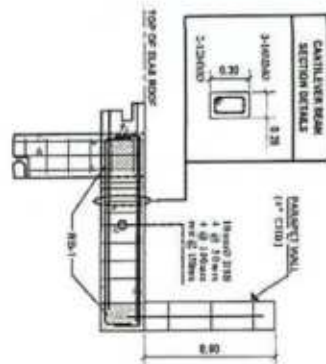
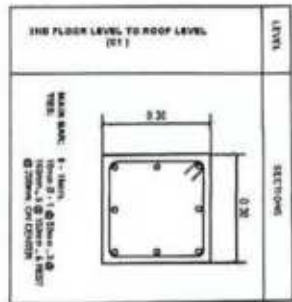

# RC COLUMN & CANTILEVER BEAM DETAILS

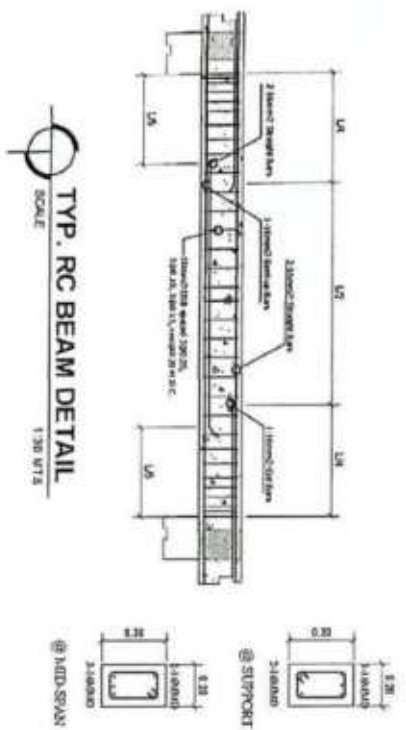

TYP. RC BEAM DETAIL  
SCALE 1/30 NTS

### SCHEDULE OF SLAB

MARK	THICKNESS (mm)	TOP BARS @ SUPPORT	REINFORCEMENT (mm)	CONCRETE GRADE
S1	130	12mm, Ø @ 0.15m O.C. (SS)	12mm, Ø @ 0.15m O.C. (LS)	10mm, Ø SPACED @ 0.30m ON CENTER BOTHWAYS
S2	150	12mm, Ø @ 0.15m O.C. (LS)	12mm, Ø @ 0.15m O.C. (LS)	10mm, Ø SPACED @ 0.30m ON CENTER BOTHWAYS

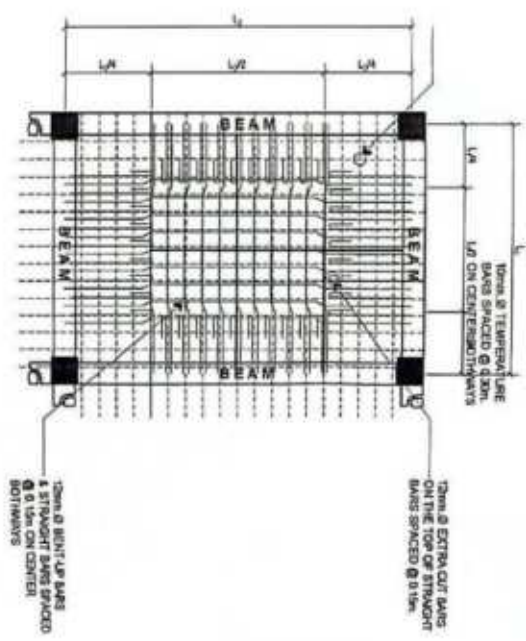

DETAIL OF SLAB  
NTS

<p>Republic of the Philippines Province of Cavendish North Office of the Provincial Engineer Date</p>	PROJECT TITLE/DESCRIPTION	ENGINEER	CHECKED BY	RECOMMENDED APPROVAL	APPROVAL BY	DATE
	CONSTRUCTION OF 2ND FLOOR BARANGAY HALL OF MALALANANG BRGY. MALALANANG, PARANGAL, CAVENDISH NORTH	FRANCO LYCAN-SOTER ENGINEER-IN-CHARGE	SAMUEL V. TORIO CHIEF PLANNING OFFICER	JUAN MERVIN S. TOBIAS MUNICIPAL ENGINEER	RICHARDE K. PADILLA SOLIDWORKER	AS SHOWN







Republic of the Philippines  
 Professional Engineers Board  
 Office of the Provincial Engineer  
 Davao

PROJECT TITLE/DESCRIPTION  
**CONSTRUCTION OF 2ND FLOOR  
 BANGUNAN AT WALK  
 OF BANGUNAN AT WALK**

PREPARED BY  
**FRANZ LYNCAPI BOTEN**  
 ENGINEER/ARCHITECT

CHECKED BY  
**SAMUEL T. TORDO**  
 CHIEF PLANNING DIVISION

RECOMMENDED APPROVAL  
**JOHN MARVIN S. TOBIAS**  
 MUNICIPAL ENGINEER

AUTHORIZED BY  
**RICARDO T. PADILLA**  
 GOVERNOR

DATE	REV.	DESCRIPTION
AS SHOWN	1	
	1	

**ROOF RAINWATER DRAINAGE SYSTEM**  
 SCALE 1:100

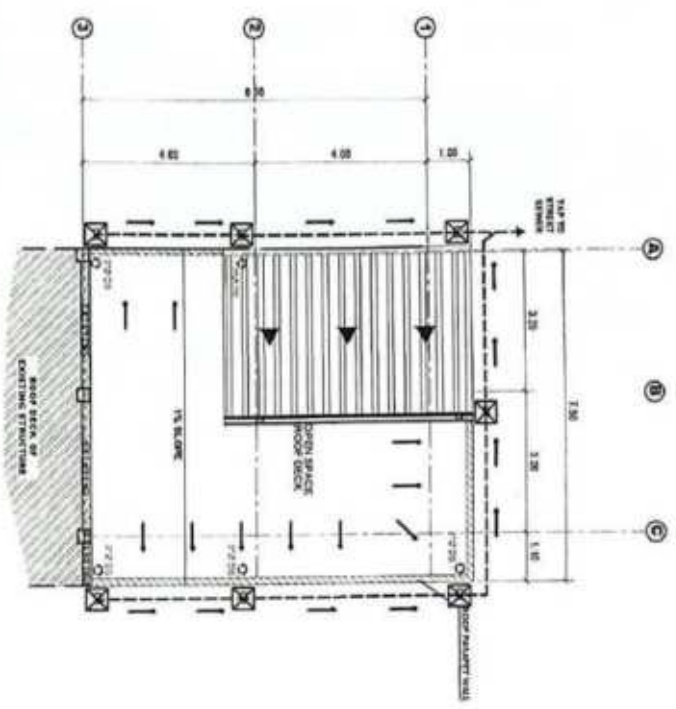

**ISOMETRIC:  
 ROOF RAINWATER DRAINAGE SYSTEM**  
 SCALE 1:100

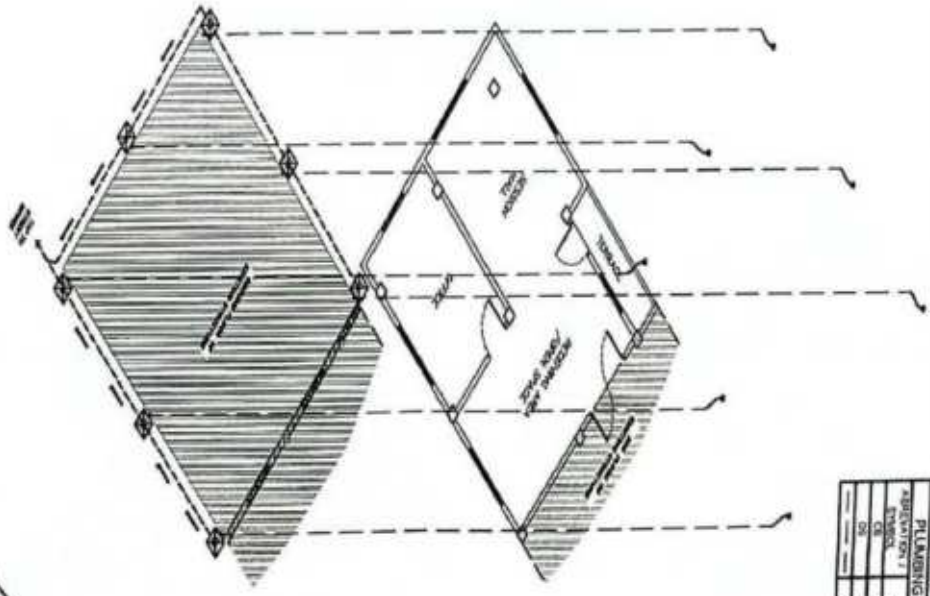

PLUMBING LEGEND	
PIPE	DIS. SYSTEM
WALL	EXTER. WALL
DOOR	DOOR
WINDOW	WINDOW
ROOF	ROOF
ROOF RAINWATER WALL	ROOF RAINWATER WALL



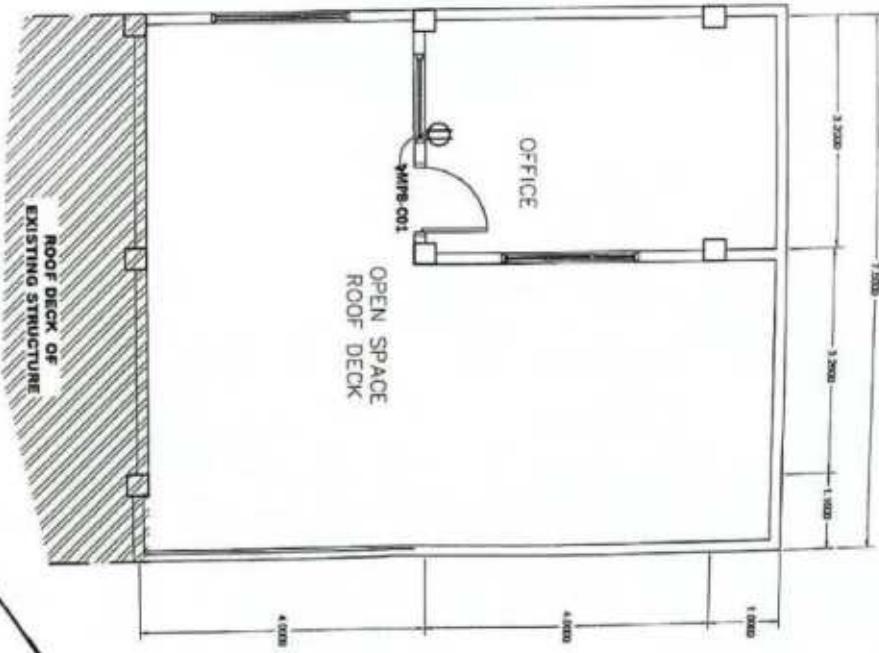
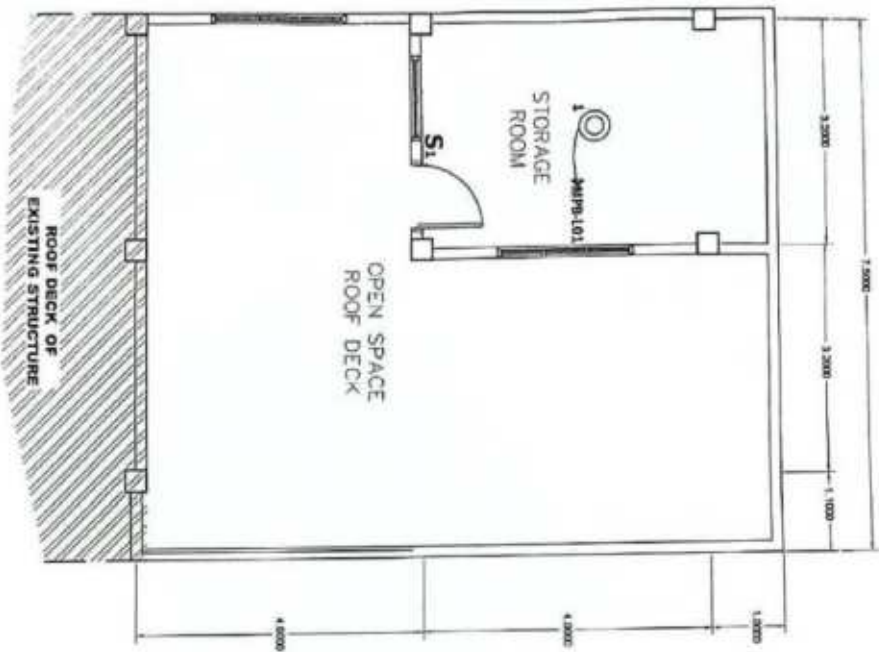

Republic of the Philippines  
 Province of Cavendish State  
 Office of the Provincial Engineer  
 Date

PROJECT TITLE/LOCATION  
 CONSTRUCTION OF 2ND FLOOR  
 BARANGAY HALL OF MALACBANG  
 DIST. MALACBANG, METROCL. COMMAND/PORT

PREPARED BY  
 ALYAN MOH'D ASH MOHD  
 JERRY R. ZARCONI  
 ELECTRICAL ENGINEER

CHECKED BY  
 SAHIEE R. YAMR  
 CHIEF PLANNING DIVISION

RECORDS/ENGINE APPROVAL  
 JOHN M. S. TOBIAS  
 DIVISION CHIEF

APPROVED BY  
 RICARDO R. PADILLA  
 DIVISION CHIEF

3RD COMMENTS  
 AS SHOWN  
 2 4



Republic of the Philippines  
 Province of Cavendish North  
 Office of the Provincial Engineer  
 Davao

PROJECT TITLE/LOCATION:  
**CONSTRUCTION OF 2ND FLOOR  
 BARANGKAY HALL OF MALLABANG  
 BHW, MALLABANG PROVINCE CAVENDISH NORTH**

PREPARED BY:  
**ADITYA RAVI MOHD SAEED MOHD  
 SAIED J. ZARROONI**  
 ELECTRICAL ENGINEER

CHECKED BY:  
**SHERIFF Y. ALTO**  
 ELECTRICAL ENGINEER

RECORDING ENGINEER:  
**JOHN LUIS S. TOBIAS**  
 ELECTRICAL ENGINEER

CONSULTANT:  
**RICHARD R. PADILLA**  
 CONSULTANT

DATE OF PREPARATION: AS SHOWN  
 SHEET NO. 3 OF 4

**SCHEDULE OF LOADS**

CIR. NO.	CIR. NAME	LOAD DESCRIPTION	GROSS REQUIREMENT (AMPERES)				VOLT-AMPERES	SIZE OF CONDUIT (ONE IN CONDUIT)		
			IP	GA	W-COM	D/W/IF				
1	20	21 - LIGHTING OUTLETS	-	2100	-	0.80	1	1.13	1600	2-3-Squarem THHN IN 20mm <sup>2</sup> PVC
2	20	7 - LIGHTING OUTLETS	-	700	-	0.80	1	3.04	900	2-3-Squarem THHN IN 20mm <sup>2</sup> PVC
3	20	12 - CONDUITANCE OUTLETS	-	2400	-	0.80	1	10.43	1820	2-3-Squarem THHN IN 20mm <sup>2</sup> PVC
4	20	4 - GEAR FAN	-	900	-	0.80	1	3.49	640	2-3-Squarem THHN IN 20mm <sup>2</sup> PVC
5	20	AIR CONDITIONER UNIT	3.0	-	3810	1	1	17	3810	2-5-Squarem THHN IN 20mm <sup>2</sup> PVC
6	20	SWIRE	-	1500	-	-	-	-	1500	
TOTAL:			3	7500	-	-	-	-	10210	

**CALCULATIONS:**  
 TOTAL CMA = 7500 + 3810 = 11410 VA  
 TOTAL DVA = 10210 VA  
 I LOAD for MCB = 10210/230 + (1.5 x 17) = 62.88 AMPS  
 I LOAD for MDR = 10210/230 + (0.25 x 17) = 46.64 AMPS  
 KW FACT. = 230 x 46.64/1000 = 11.19 KW

**USE:**  
 MAIN CIR. BRK: 2P 100A  
 MAIN FEEDER: 2 - 30 sqmm THHN IN 40mm<sup>2</sup> PVC

**RISER DIAGRAM**

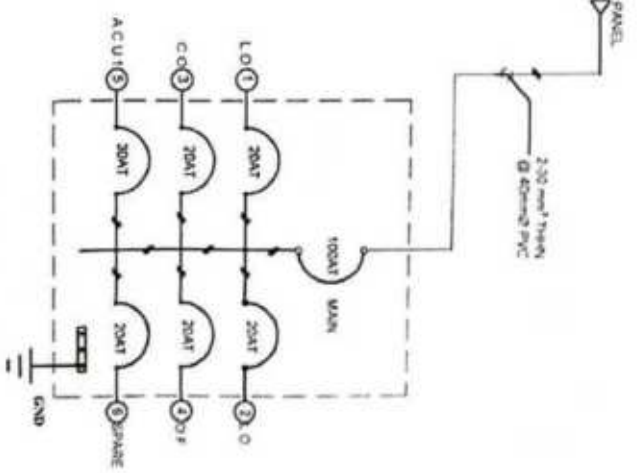



# LEGEND AND SYMBOLS

SYMBOL	ITEM DESCRIPTION
S <sub>1</sub>	SINGLE (1) GANG SWITCH, WALL MOUNTED
S <sub>2</sub>	TWO (2) GANG SWITCH, WALL MOUNTED
S <sub>3</sub>	THREE (3) GANG SWITCH, WALL MOUNTED
	CONVENIENCE OUTLET DUPLEX, WALL MOUNTED
	9W LED BULB
	36W LED SLIM PANEL
	6W LED Panel Surface Type Ceiling Lamp
	AIR CONDITION UNIT OUTLET
	15W LED Recessed Circular Downlight
	ORBIT FAN
	PANELBOARD
	SERVICE ENTRANCE
	CIRCUIT BREAKER
	GROUND
	CIRCUIT LINE

# SPECIFICATIONS:

1. ALL ELECTRICAL WORKS HEREIN SHALL BE DONE IN ACCORDANCE WITH THE RULES AND REGULATIONS OF THE LATEST EDITION OF THE PHILIPPINE ELECTRICAL CODE AND WITH THE LOCAL UTILITY POWER COMPANY.
2. ALL MATERIALS TO BE USED SHALL BE NEW AND APPROVED TYPE TO THE LOCATION.
3. MINIMUM SIZE OF WIRE SHALL BE 3.5mm<sup>2</sup> THIN AND 20 mmØ PVC SERIES 1000 ELECTRICAL PIPE OR UNLESS SPECIFIED.
4. MOUNTING HEIGHT OF DEVICES APPROVED BY ENGINEERING ASSISTANT IN CHARGE AS FOLLOWS:  
 PANEL BOARD-1.80 m. ABOVE FLOOR LINE  
 SWITCHES-1.40 m. ABOVE FLOOR LINE  
 CONVENIENCE OUTLET-0.45 m. ABOVE FLOOR LINE
5. WHENEVER REQUIRED AND NECESSARY, PULL BOXES AND JUNCTION BOXES OF PROPER SIZE SHALL BE INSTALLED ALTHOUGH SUCH BOXES ARE NOT SHOWN ON THE PLANS.
6. ALL WORKS SHALL BE DONE UNDER THE SUPERVISION OF A DULY LICENSED ELECTRICAL ENGINEER OR REGISTERED WIREMAN ELECTRICIAN.
7. ALL WIRING SHALL BE INSTALLED IN STANDARD WOLDFLEX OR PVC ELECTRICAL CONDUITS RUN EMBEDDED INSIDE THE CONCRETE AND HOLLOW BLOCK STRUCTURES, SLABS, COLUMNS, WALLS, PARTITIONS AND INSIDE THE CEILING SPACES, WHERE THE USE OF CONCEALED CONDUIT WIRING IS IMPRACTICABLE SURFACE METAL, PVC MOULDING MAY BE USED.



Republic of the Philippines  
 Province of Cavendish Area  
 Office of the Provincial Engineer  
 Date

PROJECT TITLE/LOCATION: CONSTRUCTION OF 2ND FLOOR BARANANGY HALL OF MALACBANG  
 BRIG. MALACBANG, MALACAL COMBINATION

PREPARED BY: ALLIYAN MOHD SALEH MOHD SAIEDU ZARONI  
 ENGINEERING

CHECKED BY: SAJJED SAJJED  
 DR. RANAROVORN

RECOMMENDED APPROVAL: JOHN PAUL S. TORIAS  
 REGIONAL ENGINEER

APPROVED BY: RICARTE PADILLA  
 GOVERNOR

DATE COMPLETED: AS SHOWN

REV. NO. 4 4

**DRAWINGS AVAILABLE AT THE BAC OFFICE**

## ***Section VIII. Bill of Quantities***

## BILL OF QUANTITIES

### CONSTRUCTION OF 2<sup>ND</sup> FLR BRGY HALL OF MALACBANG

Brgy. Malacbang, Paracale, Camarines Norte

Item No.	Scope of Work	Unit	Quantity	Unit Price	TOTAL
I	RC COLUMN	CU.M.	4.37		
II	RC BEAM	CU.M.	5.11		
III	MASONRY WORKS	SQ.M.	160.18		
IV	RC SLAB	CU.M.	7.20		
V	CEILING WORKS	SQ.M.	76.00		
VI	PAINTING WORKS	SQ.M.	428.36		
VII	TILE WORKS	SQ.M.	76.00		
VIII	RAILING	LOT	1.00		
IX	ELECTRICAL WORKS	LOT	1.00		
X	DOORS AND WINDOWS	LOT	1.00		
XI	WATERPROOFING	SQ.M.	60.00		
XII	ROOF FRAMING	LOT	1.00		
XIII	ROOF TINNING	LOT	1.00		
SPL-I	HEALTH AND SAFETY	LOT	1.00		
SPL-II	PROJECT BILLBOARD / SIGNBOARD	EACH	1.00		
<b>TOTAL</b>					

Amount in words:

\_\_\_\_\_

\_\_\_\_\_

\_\_\_\_\_  
Signature over Printed Name

Date:



***Section IX. Checklist of Technical and Financial Documents***

# Checklist of Technical and Financial Documents

## I. TECHNICAL COMPONENT ENVELOPE

### *Class “A” Documents*

#### Legal Documents

- (a) Valid PhilGEPS Registration Certificate (Platinum Membership) (all pages);  
**And**
- (b) Registration certificate from Securities and Exchange Commission (SEC), Department of Trade and Industry (DTI) for sole proprietorship, or Cooperative Development Authority (CDA) for cooperatives or its equivalent document;  
**And**
- (c) Mayor’s or Business permit issued by the city or municipality where the principal place of business of the prospective bidder is located, or the equivalent document for Exclusive Economic Zones or Areas;  
**And**
- (e) Tax clearance per E.O. No. 398, s. 2005, as finally reviewed and approved by the Bureau of Internal Revenue (BIR).

#### Technical Documents

- (f) Statement of the prospective bidder of all its ongoing government and private contracts, including contracts awarded but not yet started, if any, whether similar or not similar in nature and complexity to the contract to be bid; **and**
- (g) Statement of the bidder’s Single Largest Completed Contract (SLCC) similar to the contract to be bid, except under conditions provided under the rules; **and**
- (h) Philippine Contractors Accreditation Board (PCAB) License;  
**or**  
Special PCAB License in case of Joint Ventures;  
**and** registration for the type and cost of the contract to be bid; **and**
- (i) Original copy of Bid Security. If in the form of a Surety Bond, submit also a certification issued by the Insurance Commission;  
**or**  
Original copy of Notarized Bid Securing Declaration; **and**
- (j) Project Requirements, which shall include the following:
  - a. Organizational chart for the contract to be bid;
  - b. Affidavit of Availability of Key Personnel and Equipment (notarized)
  - c. List of contractor’s key personnel (*e.g.*, Project Manager, Project Engineers, Materials Engineers, and Foremen), to be assigned to the contract to be bid, with their complete qualification and experience data;
  - d. Key Personnel’s Certificate of Employment (notarized)
  - e. List of contractor’s major equipment units, which are owned, leased, and/or under purchase agreements, supported by proof of ownership or certification of availability of equipment from the equipment lessor/vendor for the duration of the project, as the case may be; **and**
- (k) Original copy of Affidavit of Site Inspection; **and**

(1)Original duly signed Omnibus Sworn Statement (OSS);

**and** if applicable, Original Notarized Secretary's Certificate in case of a corporation, partnership, or cooperative; or Original Special Power of Attorney of all members of the joint venture giving full power and authority to its officer to sign the OSS and do acts to represent the Bidder.

- (m) Approved Plan

]

*Financial Documents*

- (n) The prospective bidder's audited financial statements, showing, among others, the prospective bidder's total and current assets and liabilities, stamped "received" by the BIR or its duly accredited and authorized institutions, for the preceding calendar year which should not be earlier than two (2) years from the date of bid submission; **and**
- (o) The prospective bidder's computation of Net Financial Contracting Capacity (NFCC).

*Class "B" Documents*

- (p) If applicable, duly signed joint venture agreement (JVA) in accordance with RA No. 4566 and its IRR in case the joint venture is already in existence; **or** duly notarized statements from all the potential joint venture partners stating that they will enter into and abide by the provisions of the JVA in the instance that the bid is successful.

**II. FINANCIAL COMPONENT ENVELOPE**

- (q) Original of duly signed and accomplished Financial Bid Form; **and**

*Other documentary requirements under RA No. 9184*

- (r) Original of duly signed Bid Prices in the Bill of Quantities; **and**
- (s) Duly accomplished Detailed Estimates Form, including a summary sheet indicating the unit prices of construction materials, labor rates, and equipment rentals used in coming up with the Bid; **and**
- (t) Cash Flow by Quarter.

---

## BID FORM

Date : \_\_\_\_\_

Project Identification No. : \_\_\_\_\_

**To: HON. RICARTE R. PADILLA**  
**Governor**  
**PLGU- Camarines Norte**

Having examined the Philippine Bidding Documents (PBDs) including the Supplemental or Bid Bulletin Numbers *[insert numbers]*, the receipt of which is hereby duly acknowledged, we, the undersigned, declare that:

- a. We have no reservation to the PBDs, including the Supplemental or Bid Bulletins, for the Procurement Project: *[insert project name]*;
- b. We offer to execute the Works for this Contract in accordance with the PBDs;
- c. The total price of our Bid in words and figures, excluding any discounts offered below is: *[insert information]*;
- d. The discounts offered and the methodology for their application are: **NONE**;
- e. The total bid price includes the cost of all taxes, such as, but not limited to: *(i) value added tax (VAT), (ii) income tax, (iii) local taxes, and (iv) other fiscal levies and duties*, which are itemized herein and reflected in the detailed estimates,
- f. Our Bid shall be valid within the period stated in the PBDs, and it shall remain binding upon us at any time before the expiration of that period;
- g. If our Bid is accepted, we commit to obtain a Performance Security in the amount of **30%** percent of the Contract Price for the due performance of the Contract, or a **Performance Securing Declaration** in lieu of the allowable forms of Performance

Security, subject to the terms and conditions of issued GPPB guidelines<sup>1</sup> for this purpose;

- h. We are not participating, as Bidders, in more than one Bid in this bidding process, other than alternative offers in accordance with the Bidding Documents;
- i. We understand that this Bid, together with your written acceptance thereof included in your notification of award, shall constitute a binding contract between us, until a formal Contract is prepared and executed; and
- j. We understand that you are not bound to accept the Lowest Calculated Bid or any other Bid that you may receive.
- k. We likewise certify/confirm that the undersigned, is the duly authorized representative of the bidder, and granted full power and authority to do, execute and perform any and all acts necessary to participate, submit the bid, and to sign and execute the ensuing contract for the *[insert project name]* of the **Provincial Government of Camarines Norte**.
- l. We acknowledge that failure to sign each and every page of this Bid Form, including the Bill of Quantities, shall be a ground for the rejection of our bid.

Name: \_\_\_\_\_

Legal Capacity: \_\_\_\_\_

Signature: \_\_\_\_\_

Duly authorized to sign the Bid for and behalf of: \_\_\_\_\_

Date: \_\_\_\_\_

REPUBLIC OF THE PHILIPPINES)

CITY OF \_\_\_\_\_) S.S.

\_\_\_\_\_

## **BID SECURING DECLARATION**

**Project Identification No.: *[Insert number]***

To:       ***HON. RICARTE R. PADILLA***  
              ***Governor***  
  
              ***PLGU- Camarines Norte***

I/We, the undersigned, declare that:

1. I/We understand that, according to your conditions, bids must be supported by a Bid Security, which may be in the form of a Bid Securing Declaration.
2. I/We accept that: (a) I/we will be automatically disqualified from bidding for any procurement contract with any procuring entity for a period of two (2) years upon receipt of your Blacklisting Order; and, (b) I/we will pay the applicable fine provided under Section 6 of the Guidelines on the Use of Bid Securing Declaration, within fifteen (15) days from receipt of the written demand by the procuring entity for the commission of acts resulting to the enforcement of the bid securing declaration under Sections 23.1(b), 34.2, 40.1 and 69.1, except 69.1(f), of the IRR of RA No. 9184; without prejudice to other legal action the government may undertake.
3. I/We understand that this Bid Securing Declaration shall cease to be valid on the following circumstances:
  - a. Upon expiration of the bid validity period, or any extension thereof pursuant to your request;
  - b. I am/we are declared ineligible or post-disqualified upon receipt of your notice to such effect, and (i) I/we failed to timely file a request for reconsideration or (ii) I/we filed a waiver to avail of said right; and
  - c. I am/we are declared the bidder with the Lowest Calculated Responsive Bid, and I/we have furnished the performance security and signed the Contract.

IN WITNESS WHEREOF, I/We have hereunto set my/our hand/s this \_\_\_\_\_ day of *[month]* *[year]* at *[place of execution]*.

*[Insert NAME OF BIDDER OR ITS AUTHORIZED REPRESENTATIVE]*

*[Insert signatory's legal capacity]*

Affiant

**[Jurat]**

*[Format shall be based on the latest Rules on Notarial Practice]*

# Contract Agreement Form

*[insert project name]*

*[not required to be submitted with the Bid, but it shall be submitted within ten (10) days after receiving the Notice of Award]*

---

## CONTRACT AGREEMENT

THIS AGREEMENT, made this *[insert date]* day of *[insert month]*, *[insert year]* between *[name and address of PROCURING ENTITY]* (hereinafter called the “Entity”) and *[name and address of Contractor]* (hereinafter called the “Contractor”).

WHEREAS, the Entity is desirous that the Contractor execute *[name and identification number of contract]* (hereinafter called “the Works”) and the Entity has accepted the Bid for *[contract price in words and figures in specified currency]* by the Contractor for the execution and completion of such Works and the remedying of any defects therein.

NOW THIS AGREEMENT WITNESSETH AS FOLLOWS:

1. In this Agreement, words and expressions shall have the same meanings as are respectively assigned to them in the Conditions of Contract hereinafter referred to.
2. The following documents as required by the 2016 revised Implementing Rules and Regulations of Republic Act No. 9184 shall be deemed to form and be read and construed as part of this Agreement, *viz.*:
  - a. Philippine Bidding Documents (PBDs);
    - i. Drawings/Plans;
    - ii. Specifications;
    - iii. Bill of Quantities;
    - iv. General and Special Conditions of Contract;
    - v. Supplemental or Bid Bulletins, if any;
  - b. Winning bidder’s bid, including the Eligibility requirements, Technical and Financial Proposals, and all other documents or statements submitted;

Bid form, including all the documents/statements contained in the Bidder’s bidding envelopes, as annexes, and all other documents submitted (*e.g.*, Bidder’s response



to request for clarifications on the bid), including corrections to the bid, if any, resulting from the Procuring Entity's bid evaluation;

- a. Performance Security;
  - b. Notice of Award of Contract and the Bidder's conforme thereto; and
  - c. Other contract documents that may be required by existing laws and/or the Procuring Entity concerned in the PBDs. **Winning bidder agrees that additional contract documents or information prescribed by the GPPB that are subsequently required for submission after the contract execution, such as the Notice to Proceed, Variation Orders, and Warranty Security, shall likewise form part of the Contract.**
3. In consideration for the sum of *[total contract price in words and figures]* or such other sums as may be ascertained, *[Named of the bidder]* agrees to *[state the object of the contract]* in accordance with his/her/its Bid.
  4. The *[Name of the procuring entity]* agrees to pay the above-mentioned sum in accordance with the terms of the Bidding.

IN WITNESS whereof the parties thereto have caused this Agreement to be executed the day and year first before written.

*[Insert Name and Signature]*

*[Insert Name and Signature]*

*[Insert Signatory's Legal Capacity]*

*[Insert Signatory's Legal Capacity]*

*for:*

*for:*

*[Insert Name of Supplier]*

*[Insert Procuring Entity]*

### **Acknowledgment**

*[Format shall be based on the latest Rules on Notarial Practice]*

# OMNIBUS SWORN STATEMENT

*[shall be submitted with the Bid]*

---

REPUBLIC OF THE PHILIPPINES )

CITY/MUNICIPALITY OF \_\_\_\_\_ ) S.S.

## AFFIDAVIT

I, [Name of Affiant], of legal age, [Civil Status], [Nationality], and residing at [Address of Affiant], after having been duly sworn in accordance with law, do hereby depose and state that:

1. *[Select one, delete the other:]*

*[If a sole proprietorship:]* I am the sole proprietor or authorized representative of [Name of Bidder] with office address at [address of Bidder];

*[If a partnership, corporation, cooperative, or joint venture:]* I am the duly authorized and designated representative of [Name of Bidder] with office address at [address of Bidder];

2. *[Select one, delete the other:]*

*[If a sole proprietorship:]* As the owner and sole proprietor, or authorized representative of [Name of Bidder], I have full power and authority to do, execute and perform any and all acts necessary to participate, submit the bid, and to sign and execute the ensuing contract for [Name of the Project] of the [Name of the Procuring Entity], as shown in the attached duly notarized Special Power of Attorney;

*[If a partnership, corporation, cooperative, or joint venture:]* I am granted full power and authority to do, execute and perform any and all acts necessary to participate, submit the bid, and to sign and execute the ensuing contract for [Name of the Project] of the [Name of the Procuring Entity], as shown in the attached [state title of attached document showing proof of authorization (e.g., duly notarized Secretary's Certificate, Board/Partnership Resolution, or Special Power of Attorney, whichever is applicable)];

1. [Name of Bidder] is not "blacklisted" or barred from bidding by the Government of the Philippines or any of its agencies, offices, corporations, or Local Government Units, foreign government/foreign or international financing institution whose blacklisting rules have been recognized by the Government Procurement Policy Board, **by itself or by relation, membership, association, affiliation, or controlling interest with another**

**blacklisted person or entity as defined and provided in the Uniform Guidelines on Blacklisting;**

3. Each of the documents submitted in satisfaction of the bidding requirements is an authentic copy of the original, complete, and all statements and information provided therein are true and correct;
4. [Name of Bidder] is authorizing the Head of the Procuring Entity or its duly authorized representative(s) to verify all the documents submitted;

5. *[Select one, delete the rest:]*

*[If a sole proprietorship:]* The owner or sole proprietor is not related to the Head of the Procuring Entity, members of the Bids and Awards Committee (BAC), the Technical Working Group, and the BAC Secretariat, the head of the Project Management Office or the end-user unit, and the project consultants by consanguinity or affinity up to the third civil degree;

*[If a partnership or cooperative:]* None of the officers and members of [Name of Bidder] is related to the Head of the Procuring Entity, members of the Bids and Awards Committee (BAC), the Technical Working Group, and the BAC Secretariat, the head of the Project Management Office or the end-user unit, and the project consultants by consanguinity or affinity up to the third civil degree;

*[If a corporation or joint venture:]* None of the officers, directors, and controlling stockholders of [Name of Bidder] is related to the Head of the Procuring Entity, members of the Bids and Awards Committee (BAC), the Technical Working Group, and the BAC Secretariat, the head of the Project Management Office or the end-user unit, and the project consultants by consanguinity or affinity up to the third civil degree;

6. [Name of Bidder] complies with existing labor laws and standards; and
7. [Name of Bidder] is aware of and has undertaken the responsibilities as a Bidder in compliance with the Philippine Bidding Documents, which includes:
  - a. Carefully examining all of the Bidding Documents;
  - b. Acknowledging all conditions, local or otherwise, affecting the implementation of the Contract;
  - c. Making an estimate of the facilities available and needed for the contract to be bid, if any; and
  - a. Inquiring or securing Supplemental/Bid Bulletin(s) issued for the [Name of the

*Project].*

8. *[Name of Bidder]* did not give or pay directly or indirectly, any commission, amount, fee, or any form of consideration, pecuniary or otherwise, to any person or official, personnel or representative of the government in relation to any procurement project or activity.
  
9. **In case advance payment was made or given, failure to perform or deliver any of the obligations and undertakings in the contract shall be sufficient grounds to constitute criminal liability for Swindling (Estafa) or the commission of fraud with unfaithfulness or abuse of confidence through misappropriating or converting any payment received by a person or entity under an obligation involving the duty to deliver certain goods or services, to the prejudice of the public and the government of the Philippines pursuant to Article 315 of Act No. 3815 s. 1930, as amended, or the Revised Penal Code.**

IN WITNESS WHEREOF, I have hereunto set my hand this \_\_\_ day of \_\_\_, 20\_\_ at \_\_\_\_\_, Philippines.

*[Insert NAME OF BIDDER OR ITS AUTHORIZED REPRESENTATIVE]*

*[Insert signatory's legal capacity]*

Affiant

**[Jurat]**

*[Format shall be based on the latest Rules on Notarial Practice]*

---

REPUBLIC OF THE PHILIPPINES)

CITY OF \_\_\_\_\_) S.S.

**AFFIDAVIT OF SITE INSPECTION**

I, (Representative of the Bidder), of legal age, (civil status), Filipino and residing at (Address of the Representative), under oath, hereby depose and say:

1. That I am the (Position in the Bidder) of the (Name of the Bidder), with office at (Address of the Bidder);
2. That I have inspected the site for (Name of the Contract), located at (location of the Contract);
3. That I am making this statement as part of the requirement for the Technical Proposal of the (Name of the Bidder) for (Name of the Contract).

**IN FAITH WHEREOF**, I hereby affix my signature this \_\_\_\_\_ day of \_\_\_\_\_, 20\_\_ at \_\_\_\_\_, Philippines.

\_\_\_\_\_  
AFFIANT

Witness:

\_\_\_\_\_

**SUBSCRIBED AND SWORN TO** before me this \_\_\_\_\_, day of \_\_\_\_\_ 20\_\_, affiant exhibiting to me his/her Community Tax Certificate No. \_\_\_\_\_ issued on \_\_\_\_\_ at \_\_\_\_\_, Philippines.

\_\_\_\_\_  
(Notary Public)

Until \_\_\_\_\_  
PTR No. \_\_\_\_\_  
Date \_\_\_\_\_  
Place \_\_\_\_\_  
TIN \_\_\_\_\_

Doc. No. \_\_\_\_\_  
Page No. \_\_\_\_\_  
Book No. \_\_\_\_\_  
Series of \_\_\_\_\_  
Bids and Awards Committee

**AFFIDAVIT OF AVAILABILITY OF KEY PERSONNEL AND EQUIPMENT**

I, \_\_\_\_\_ of legal age, Filipino, married/single/widow, and, a resident of \_\_\_\_\_, owner/proprietor of \_\_\_\_\_ after having been duly sworn to in accordance with law, depose and declare;

1. That I/we have engage and contracted the service of Engr. \_\_\_\_\_ (herein called the Resident/Project Engineer), a Registered Civil Engineer with Professional License No. \_\_\_\_\_ issued on \_\_\_\_\_ and who has paid his Professional Tax for the Current Year \_\_\_\_\_;
2. That the said Engineer shall be appointed and designated as our Resident/Project Engineer to personally manage and supervise the construction.
3. That the said Engineer shall employ the best care, skill and ability in supervising the project in accordance with the Contract Agreement, contract plan, and other provisions embodied in the proposed contract;
4. That the said Engineer shall be personally present at the jobsite to supervise all the phase of the construction work at all time;
5. That all other key personnel are available for the project;
6. That equipment needed for the project, are likewise available;
7. That any willful violation on my/our part of the herein condition may prejudice my/our standing as a reliable contractor in future biddings in your office.

**IN WITNESS WHEREOF**, I have here unto set my hands this \_\_\_\_\_ day of \_\_\_\_\_, 20\_\_\_\_ at \_\_\_\_\_, Philippines.

\_\_\_\_\_  
Affiant's Printed Name and Signature

WITNESSES:

\_\_\_\_\_

**SUBSCRIBED AND SWORN** to before me this \_\_\_\_\_ day of \_\_\_\_\_, 20\_\_\_\_ affiant exhibiting to me his/her Resident Certificate No.: \_\_\_\_\_ issued \_\_\_\_\_ at \_\_\_\_\_.

\_\_\_\_\_  
Notary Public

Doc No.: \_\_\_\_\_  
Page No.: \_\_\_\_\_  
Book No.: \_\_\_\_\_  
Series of: \_\_\_\_\_

Bids and Awards Committee  
 Provincial Government of Camarines Norte  
 Provincial Capitol Building  
 Daet, Camarines Norte

**KEY PERSONNEL’S CERTIFICATE OF EMPLOYMENT**

\_\_\_\_\_ *Date*

\_\_\_\_\_  
 \_\_\_\_\_  
 \_\_\_\_\_  
 \_\_\_\_\_

Dear Sir / Madame:

I am       (Name of Nominee)       a Licensed Engineer with Professional License No. \_\_\_\_\_ issued on       (date of issuance)       at       (place of issuance)      .

I hereby certify that       (Name of Bidder)       has engaged my services as       (Designation)       for       (Name of the Contract)      , if awarded to it.

As       (Designation)      , I supervised the following completed projects similar to the contract under bidding:

<u>NAME OF PROJECT</u>	<u>OWNER</u>	<u>COST</u>	<u>DATE COMPLETED</u>
_____	_____	_____	_____
_____	_____	_____	_____
_____	_____	_____	_____
_____	_____	_____	_____

At present, I am supervising the following projects:

<u>NAME OF PROJECT</u>	<u>OWNER</u>	<u>COST</u>	<u>DATE COMPLETED</u>
_____	_____	_____	_____
_____	_____	_____	_____
_____	_____	_____	_____
_____	_____	_____	_____

In case of my separation for any reason whatsoever from the above-mentioned Contractor, I shall notify the       (Name of the Procuring Entity)       at least twenty one (21) days before the effective date of my separation.

As (Designation), I know I will have to stay in the job site all the time to supervise and manage the Contract works to the best of my ability, and aware that I am authorized to handle only one (1) contract at a time.

I do not allow the use of my name for the purpose of enabling the above-mentioned Contractor to qualify for the Contract without any firm commitment on my part to assume the post of (Designation) therefore, if the contract is awarded to him since I understand that to do so will be a sufficient ground for my disqualification as (Designation) in any future (Name of the Procuring Entity) bidding or employment with any Contractor doing business with the (Name of the Procuring Entity).

\_\_\_\_\_  
(Signature of Engineer)

WITNESSES:

\_\_\_\_\_

DRY SEAL

Republic of the Philippines )  
\_\_\_\_\_ ) S.S.

**SUBSCRIBED AND SWORN TO** before me this \_\_\_\_\_ day of \_\_\_\_\_ 20\_\_ affiant exhibiting to me his Residence Certificate No. \_\_\_\_\_ issued on \_\_\_\_\_ at \_\_\_\_\_.

NOTARY PUBLIC  
PTR No.: \_\_\_\_\_  
Issued at: \_\_\_\_\_  
Issued on: \_\_\_\_\_  
Until 31 December 20\_\_\_\_

Doc. No.: \_\_\_\_\_;  
Page No. : \_\_\_\_\_;  
Book No.: \_\_\_\_\_;  
Series of \_\_\_\_\_;



## PERFORMANCE SECURING DECLARATION

Invitation to Bid: [Insert Reference Number indicated in the Bidding Documents]

To: ***HON. RICARTE R. PADILLA***  
***Governor***  
***PLGU- Camarines Norte***

I/We, the undersigned, declare that:

1. I/We understand that, according to your conditions, to guarantee the faithful performance by the supplier/distributor/manufacturer/contractor/consultant of its obligations under the Contract, I/we shall submit a Performance Securing Declaration within a maximum period of ten (10) calendar days from the receipt of the Notice of Award prior to the signing of the Contract.
2. I/We accept that: I/we will be automatically disqualified from bidding for any procurement contract with any procuring entity for a period of one (1) year for the first offense, or two (2) years **for the second offense**, upon receipt of your Blacklisting Order if I/We have violated my/our obligations under the Contract;
3. I/We understand that this Performance Securing Declaration shall cease to be valid upon:
  - a. issuance by the Procuring Entity of the Certificate of Final Acceptance, subject to the following conditions:
    - i. Procuring Entity has no claims filed against the contract awardee;
    - ii. It has no claims for labor and materials filed against the contractor; and
    - iii. Other terms of the contract; or
  - b. replacement by the winning bidder of the submitted PSD with a performance security in any of the prescribed forms under Section 39.2 of the 2016 revised IRR of RA No. 9184 as required by the end-user.

**IN WITNESS WHEREOF**, I/We have hereunto set my/our hand/s this \_\_\_\_day of [month] [year] at [place of execution].

*[Insert NAME OF BIDDER OR  
ITS AUTHORIZED  
REPRESENTATIVE]*

*[Insert signatory's legal capacity]*

Affiant

**[Jurat]**

*[Format shall be based on the latest Rules on Notarial Prcti*



Republic of the Philippines  
DEPARTMENT OF PUBLIC WORKS AND HIGHWAYS  
**OFFICE OF THE SECRETARY**  
Manila

*EPD. 12 8/2011*  
*10-10-2010*

07 OCT 2016

DEPARTMENT ORDER )  
NO. **197** )  
Series of 2016 )

SUBJECT: Revised Guidelines in the  
Preparation of Approved Budget for  
the Contract (ABC)

The following policies, rules and procedures relative to the preparation of the "Approved Budget for the Contract" (ABC) previously prescribed under Department Order No. 22, Series of 2015, are hereby revised/reiterated.

The ABC shall be prepared on the basis of the design plans for the project which has been duly approved by authorized officials in accordance with existing regulations.

All items of work to be used in preparing the ABC shall conform to the Standard Specifications for Highways, Bridges and Airports, revised 2013, Standard Specifications for Public Works Structures, 1995, and approved Special Specifications for the project.

The ABC shall be composed of the Direct Cost and the Indirect Cost.

A. The Direct Cost shall consist of the following:

A.1 Cost of materials to be used in doing the work item called for, which shall include, inter alia, the following:

A.1.1 Cost at source, including processing, crushing, stockpiling, loading, royalties, local taxes, construction and/or maintenance of haul roads, etc.

A.1.2 Expenses for hauling to project site.

A.1.3 Handling expenses.

A.1.4 Storage expenses.

A.1.5 Allowance for waste and/or losses, not to exceed 5% of materials requirement.

A.2 Cost of Labor:

A.2.1 Salaries and wages, as authorized by the Department of Labor and Employment.

A.2.2 Fringe benefits, such as vacation and sick leaves, benefits under the Workmen's Compensation Act, GSIS and/or SSS contributions, allowances, 13<sup>th</sup> month pay, bonuses, etc.

**A.3 Equipment Expenses:**

A.3.1 Rental rates of equipment shall be based on the prevailing "Association of Carriers and Equipment Lessors, (ACEL) Inc." approved for use by the DPWH (Presently it is the 2014 ACEL Rates). Rental rates of equipment not indicated in the ACEL booklet shall be taken from the rental rates prepared by the Bureau of Equipment. For simplicity in computation, the operated rental rates are preferred over the bare rental rates as the former includes operator's wages, fringe benefits, fuel, oil, lubricants and equipment maintenance. The make, model and capacity of the equipment should be indicated in the detailed unit cost analysis.

A.3.2 Mobilization and demobilization shall be treated as a separate pay item. It shall be computed based on the equipment requirements of the project stipulated in the proposal and contract booklet. Mobilization and demobilization shall not exceed 1% of the Estimated Direct Cost (EDC) of the civil works items. However, in special cases wherein requirements for mobilization/demobilization exceed 1%, an approval to utilize the actual computed mobilization/demobilization cost shall be secured from the concerned Undersecretary for Operations.

A.4 Cost for Permits, Clearances and other Government Taxes (i.e. MMDA Permit, LGU Permits, Bureau of Fire Protection Clearance, etc.) shall be included in the cost under Part B – Other General Requirements of the Program of Works (POW) and Estimate/ABC.

**B. The Indirect Cost shall consist of the following:**

B.1 Overhead Expenses – ranges from 7 - 11% of the EDC, which includes the following:

B.1.1 Engineering and Administrative Supervision.

B.1.2 Transportation allowances.

B.1.3 Office Expenses, e.g., for office equipment and supplies, power and water consumption, communication and maintenance.

B.1.4 Premium on Contractor's All Risk Insurance (CARI).

B.1.5 Financing Cost.

B.1.5.1 Premium on Bid Security

B.1.5.2 Premium on Performance Security

B.1.5.3 Premium on Surety for Advance Payment

B.1.5.4 Premium on Warranty Bond (one year)

B.2 Contingencies – ranges from 0.5 - 3% of the EDC. These include expenses for meetings, coordination with other stakeholders, billboards (excluding Project Billboard which is a pay item under the General Requirements), stages during ground breaking & inauguration ceremonies, and other unforeseen events.

- B.3 Miscellaneous Expenses – ranges from 0.5 - 1% of the EDC. These include laboratory tests for quality control and plan preparation.
- B.4 Contractor's Profit Margin – shall be 8% of the EDC for projects above P5Million and 10% for projects P5Million and below.
- B.5 VAT Component – shall be 5% of the sum of the EDC, OCM and Profit.
- B.6 The following items shall not be subjected to OCM and Profit mark-up:
  - B.6.1 Mobilization and demobilization
  - B.6.2 Provision of Service Vehicle
  - B.6.3 Permits and Clearances
- B.7 The following non-civil works items shall not be subjected to OCM mark-up:
  - B.7.1 Field/Laboratory Office & Living Quarters (Rental Basis)
  - B.7.2 Furnishing of Furniture, Laboratory Equipment, Survey Equipment and Consumables
  - B.7.3 Assistance to the Engineers
  - B.7.4 Photographs
  - B.7.5 Health and Safety
  - B.7.6 Traffic Management
  - B.7.7 Environmental Compliance
  - B.7.8 Communication Equipment, etc.

NOTE: For the percentage to be used for Nos. B.1, B.2 and B.3, see OCM (Overhead, Contingencies and Miscellaneous) column in the tabulation below.

ESTIMATED DIRECT COST (EDC)	INDIRECT COST % FOR OCM AND PROFIT		TOTAL INDIRECT COST % FOR OCM AND PROFIT
	OCM (% OF EDC)	PROFIT (% OF EDC)	
Up to P5Million	15	10	25
Above P5M up to P50M	12	8	20
Above P50M up to P150M	10	8	18
Above P150M	8	8	16

C. The prescribed format for the calculation of the ABC is shown in Attachment "A".

- C.1 Instructions for filling-up the format:

- C.1.1 Columns (1) to (4) are self-explanatory.
  - C.1.2 Column (5) is the EDC of the work item as calculated and reflected in the cost analysis prepared by the Estimator.
  - C.1.3 Columns (6) and (7) are the mark-ups in percent for OCM and profit.
  - C.1.4 Column (8) is the total mark-up, which is the sum of the percentages under columns (6) and (7).
  - C.1.5 Column (9) is the Peso value of the total mark-up. It is determined by multiplying the total mark-up on percent in column (8) with the EDC (column 5).
  - C.1.6 Column (10) is the VAT component which is 5% of the sum of columns (5) and (9).
  - C.1.7 Column (11) is the total estimated Indirect Cost which is the sum of columns (9) and (10).
  - C.1.8 Column (12) is the total estimated Total Cost or the sum of columns (5) and (11).
  - C.1.9 Column (13) is the unit cost for each item of works, determined by dividing the estimated Total Cost in column (12) by its total quantity in column (3).
- C.2 Procedures in preparing, processing and corresponding signatories specified under Department Order No. 163, Series of 2015 in the preparation of Program of Work (POW) and Approved Budget for the Contract (ABC) shall be observed.

Since the ABC is to be compared with the Contractor's bid and is the ceiling for acceptable bid prices in accordance with the provision of R.A. 9184, the ABC should be based on the approved Bidding Documents for the contract which contain the same work items and quantities as those to be used by the contractors in preparing their bid.

DPWH estimators shall continuously update their information/statistics on market prices of all construction inputs submitted for incorporation in the quarterly Construction Materials Price Database (CMPD). All assumptions in generating the estimate should be shown in the cost analysis.

In all cases, estimates for special items of work (SPL) should be accompanied with plans and specifications, methods of construction, measurements and payments duly approved by the Bureau of Research and Standards (BRS).

This Order shall take effect immediately and shall supersede Department Order No. 22, Series of 2015.



**MARK A. VILLAR**  
Acting Secretary

6.1 WRD/PCA

Department of Public Works and Highways  
Office of the Secretary



WIN8W01951

